



2N[®] Indoor Talk



User guide

Version: 2.25

www.2n.cz

The 2N TELEKOMUNIKACE a.s. is a Czech manufacturer and supplier of telecommunications equipment.



The product family developed by 2N TELEKOMUNIKACE a.s. includes GSM gateways, private branch exchanges (PBX), and door and lift communicators. 2N TELEKOMUNIKACE a.s. has been ranked among the Czech top companies for years and represented a symbol of stability and prosperity on the telecommunications market for almost two decades. At present, we export our products into over 120 countries worldwide and have exclusive distributors on all continents.



2N[®] is a registered trademark of 2N TELEKOMUNIKACE a.s. Any product and/or other names mentioned herein are registered trademarks and/or trademarks or brands protected by law.



2N TELEKOMUNIKACE a.s. administers the FAQ database to help you quickly find information and to answer your questions about 2N products and services. On www.faq.2n.cz you can find information regarding products adjustment and instructions for optimum use and procedures „What to do if...“.



2N TELEKOMUNIKACE a.s. hereby declares that the 2N product complies with all basic requirements and other relevant provisions of the 1999/5/EC directive. For the full wording of the Declaration of Conformity see the CD-ROM (if enclosed) or our website at www.2n.cz.



The 2N TELEKOMUNIKACE a.s. is the holder of the ISO 9001:2009 certificate. All development, production and distribution processes of the company are managed by this standard and guarantee a high quality, technical level and professional aspect of all our products.

Content:

- 1. Product Overview
 - 1.1 Product Description
 - 1.2 Differences between Models and Associated Products
 - 1.3 Terms and Symbols
 - 1.4 Safety Precautions
- 2. Description and Installation
 - 2.1 Before You Start
 - 2.2 Brief Installation Guide
 - 2.3 Installation Conditions
 - 2.4 2N® Indoor Talk LAN Location via 2N® Network Scanner
 - 2.5 IP Address Lookup
- 3. Configuration
 - 3.1 Factory Reset
 - 3.2 Software Configuration
- 4. Operational Statuses
- 5. Technical Parameters
- 6. Supplementary Information
 - 6.1 Troubleshooting
 - 6.2 Directives, Laws and Regulations - General Instructions and Cautions

1. Product Overview

In this section, we introduce the **2N[®] Indoor Talk** product, outline its application options and highlight the advantages following from its use. The section also includes safety precautions.

- 1.1 Product Description
- 1.2 Differences between Models and Associated Products
- 1.3 Terms and Symbols
- 1.4 Safety Precautions

1.1 Product Description

2N[®] Indoor Talk is an indoor IP/SIP audio unit allowing for voice communication with the 2N IP intercoms. The device includes a touchscreen, Speakerphone, microphone, Ethernet interface for LAN connection and connectors for induction loop and doorbell external supply. **2N[®] Indoor Talk** is a high-quality, cost efficient and easy-to-install and configure answering unit. One installation can combine variable answering units manufactured by 2N Telekomunikace a.s.

2N[®] Indoor Talk is equipped a specific user interface for an increased user comfort and safety.

2N[®] Indoor Talk basic features:

- display with capacitive touch layer
- full duplex handsfree audio communication
- LAN interface with PoE supply option
- easy flush mounting
- combination with **2N[®] Indoor Touch** answering units
- DND mode
- remote door lock control
- ambient lighting at relax
- light signalling of activation by call
- integrated user web interface
- external doorbell button input
- external power supply input
- induction loop input.

1.2 Differences between Models and Associated Products

Indoor Talk Units

Part No.:

91378401



- 2N[®] Indoor Talk - black
- Indoor answering audio unit with touchscreen designed for all 2N IP intercoms

Part No.:

91378401WH



- 2N[®] Indoor Talk - white
- Indoor answering audio unit with touchscreen designed for all 2N IP intercoms

Other Indoor Units and Accessories

Part Nos.:

91378365

91378375

91378366

91378376





- 2N[®] Indoor Touch - black
- WiFi version (third and fourth Part Nos.)
- 2N[®] Indoor Touch, an elegant indoor touch panel, is designed for all of the **2N IP intercoms**. The display panel shows you the person standing at your door and helps you make conversation with the visitor, open the doorlock or switch on the entrance hall lights.

Part No.:

91378382



- 2N[®] Indoor Touch - desk stand, black

<p>Part Nos.:</p> <p>91378365WH</p> <p>91378375WH</p> <p>91378366WH</p> <p>91378376WH</p> 	<ul style="list-style-type: none"> • 2N[®] Indoor Touch - white • WiFi version (third and fourth Part Nos.) • 2N[®] Indoor Touch, an elegant indoor touch panel, is designed for all of the 2N IP intercoms. The display panel shows you the person standing at your door and helps you make conversation with the visitor, open the doorlock or switch on the entrance hall lights.
<p>Part No.:</p> <p>91378382W</p> 	<ul style="list-style-type: none"> • 2N[®] Indoor Touch - desk stand, white

VoIP Phones

Part No. 91378358



- Grandstream GXV3240 VoIP video phone
- GXV3240 is the successor to the popular GXV3140 model, which allows for comfortable video calls in the IP network. Touchscreen and keypad control .

Part No. 91378357



- Grandstream GXV3275 VoIP video phone
- GXV3275 is the successor to the popular GXV3175 model, which allows for comfortable video calls in the IP network. Touchscreen control.

Power Supply

<p>Part Nos.:</p> <p>91378100</p> <p>91378100E</p> <p>91378100US</p> 	<ul style="list-style-type: none"> • PoE injector - no cable • PoE injector - with EU cable • PoE injector - with US cable • For Ethernet cable supply where PoE is unavailable
<p>Part Nos.:</p> <p>91378381E</p> <p>91378381GB</p> <p>91378381US</p> 	<ul style="list-style-type: none"> • Stabilised 12 V / 2 A power supply needs to be used where no PoE is available. • Part number according to the electric socket end piece (E/GB/US)
<p>Part No. 932928</p> 	<ul style="list-style-type: none"> • 12 V transformer • For external lock supply, AC

Mounting Accessories

Part No. 91378800



- Flush mounting box for brick/plasterboard walls
- Not included in the 2N[®] Indoor Talk package

1.3 Terms and Symbols

The following symbols and pictograms are used in the manual:

Safety

- Always abide by this information to prevent persons from injury.

Warning

- Always abide by this information to prevent damage to the device.

Caution

- Important information for system functionality.

Tip

- Useful information for quick and efficient functionality.

Note

- Routines or advice for efficient use of the device.

1.4 Safety Precautions

The manufacturer reserves the right to modify the product in order to improve its qualities. The manufacturer continuously responds to the clients' requirements by improving the software. Refer to the www.2n.cz company websites for the latest **2N[®] Indoor Talk** firmware and User Manual.

- Where necessary, **2N[®] Indoor Talk** can be installed at a safe distance from the prohibited area and an Ethernet cable can only be carried to the required site.
- Install **2N[®] Indoor Talk** out of reach of sensitive devices and human bodies as it emits electromagnetic interference.
- Refer to S. **5. Technical Parameters** for the range of operating temperatures.
- **2N[®] Indoor Talk** may not be operated at places exposed to direct sunlight or near heat sources.
- **2N[®] Indoor Talk** is designed for indoor use. It may not be exposed to rain, flowing water, condensing moisture, fog, and so on.
- **2N[®] Indoor Talk** may not be exposed to aggressive gases, acid and solvent vapours, etc.

2N[®] Indoor Talk is designed for LAN connection.

Warning

- This product and its installation and configuration techniques are not intended for persons with diminished physical, sensory or mental capacities or persons with limited experience and knowledge unless expertly supervised or duly advised as to the use of this product by a person responsible for their safety.

2. Description and Installation

This section describes how to install and connect **2N[®] Indoor Talk** properly.

Here is what you can find in this section:

- **2.1 Before You Start**
- **2.2 Brief Installation Guide**
- **2.3 Installation Conditions**
- **2.4 2N[®] Indoor Talk LAN Location via 2N[®] Network Scanner**
- **2.5 IP Address Lookup**

2.1 Before You Start

Product Completeness Check

Please check the product delivery before starting installation:

1	2N [®] Indoor Talk
1	2.5 mm hexagon key wrench
1	Quick Start manual

Front Layout

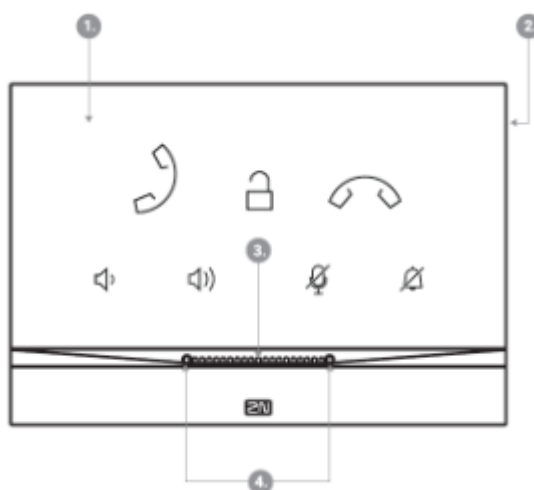

1. Panel with capacitive touch layer
2. Speaker
3. Microphone
4. Anchoring holes

Backside Connectors

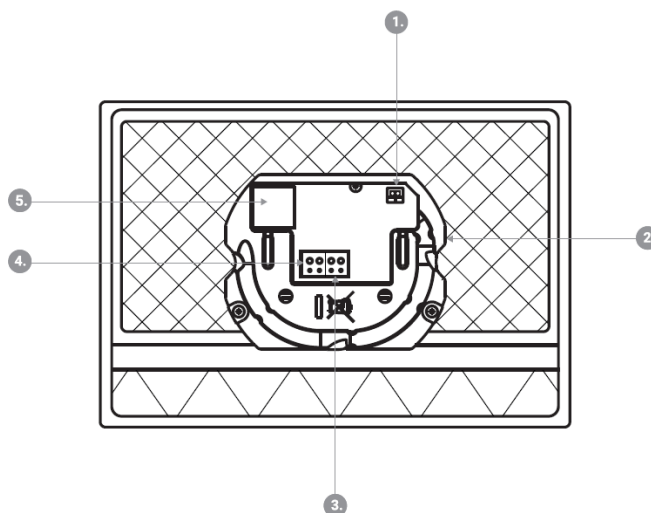

1. External induction loop output
2. Reset button
3. Doorbell button input
4. 12 V / 2 A DC power supply input
5. Ethernet

2N[®] Indoor Talk is designed exclusively for flush mounting (brick and plasterboard walls). Use the 2N[®] Indoor Talk flush mounting box (Part No. 91378800), which is not part of the delivery.

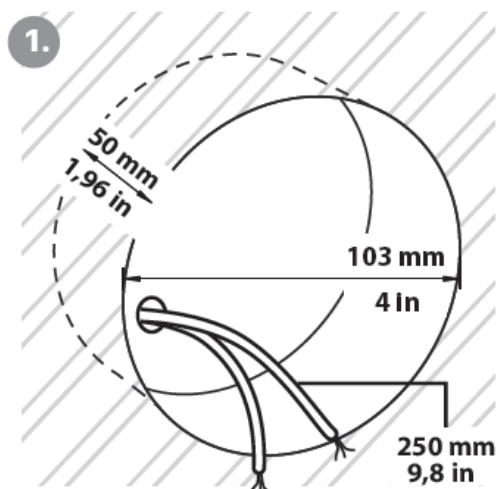

2A.

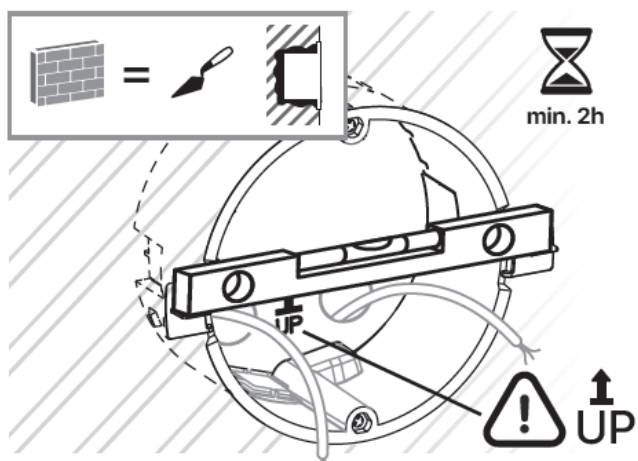

2B.

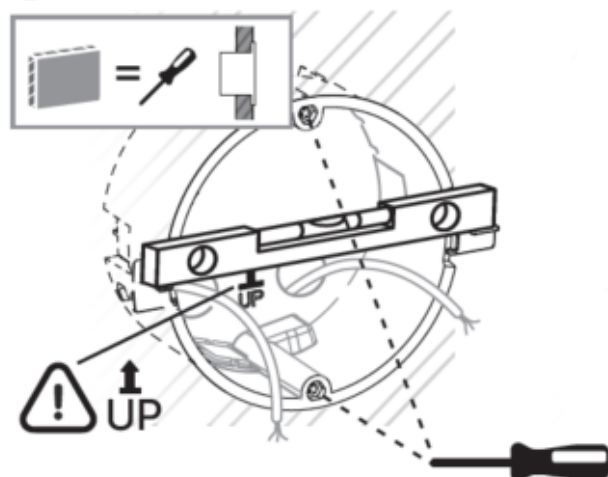

3.

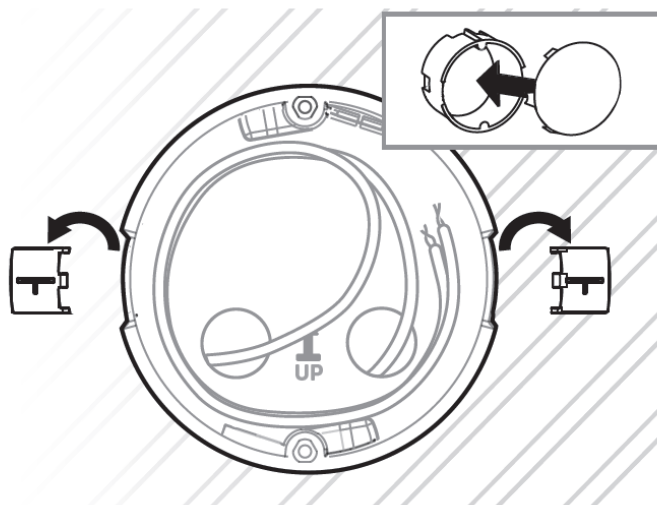

Cut a circular hole of the diameter of 103 mm and depth of 50 mm before installation. It is assumed that all necessary cables of the maximum length of 25 cm will lead to the hole. Put the flush mounting box in the hole to make sure that the hole is deep enough. If the hole complies with the box size, wall in the box and level the box using a water level on the holding clips. When the mortar hardens, break off the clips and cap the box with the cover provided. Use anchoring elements to fix the device into plasterboard.

Use a 2.5 mm hexagon key wrench (part of **2N[®] Indoor Talk delivery**) for fitting **2N[®] Indoor Talk** into the flush mounting box.

i Poznámka

- Respect the local standards concerning installation of electronic devices on flammable materials while flush mounting **2N[®] Indoor Talk**.

 **Caution**

- Press the Reset button shortly to restart **2N[®] Indoor Talk**. A LED on the device backside goes on to indicate the reset.
- Press the Reset button for up to 10 s to reset the factory defaults. The backside LED goes on to indicate the reset.

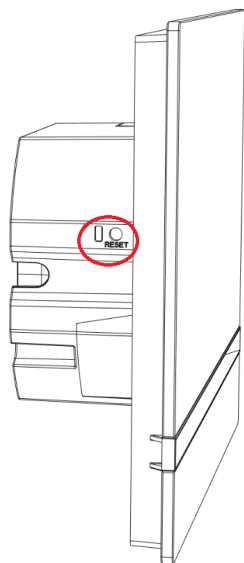

Reset button

2.2 Brief Installation Guide

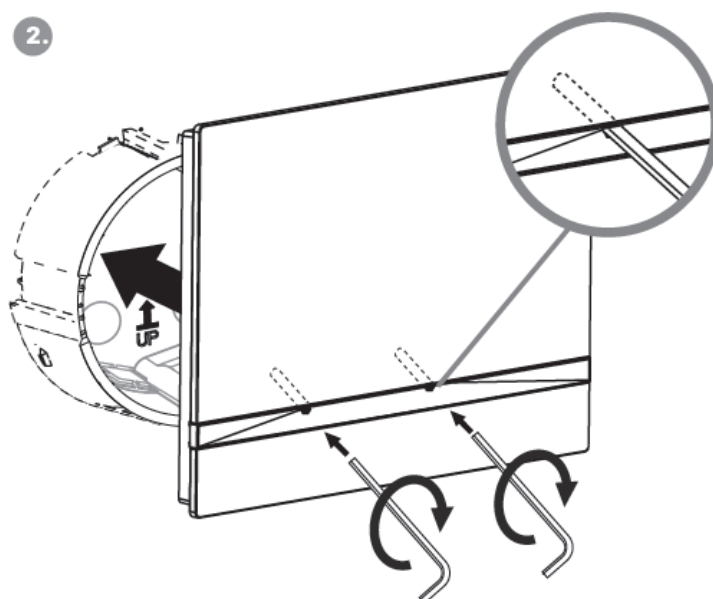
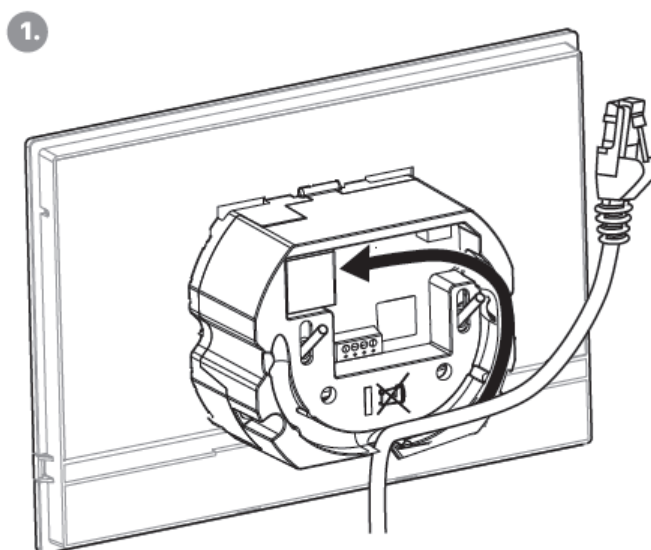

Remove the cover from the walled-in 2N[®] Indoor Talk flush mounting box. Remove the pre-prepared cabling, UTP cable, doorbell twin cable and power supply cable. Shorten the cables to 150 mm or less as required. Connect the doorbell twin cable or power supply cable to the connector provided. Crimp the RJ-45 connector onto the UTP cable.

Take **2N[®] Indoor Talk** and lean its bottom edge against the wall below the flush mounting box. First plug the green doorbell/power connector and then the LAN connector. Put the cables carefully in the pre-drilled **2N[®] Indoor Talk** back slot to prevent them from blocking any horizontal levelling movement during the final installation stage. Insert **2N[®] Indoor Talk** in the flush mounting box making sure that it clicks onto the levelling pins, which allow for a 5-6 ° inclination on either side for accurate horizontal levelling. Apply the box screw nuts with the hexagon key wrench provided. Level **2N[®] Indoor Talk** with a water level and tighten the screws gently. Now **2N[®] Indoor Talk** is ready for basic operation.

2N[®] Indoor Talk consumption with variable power supplies:

Supply type	Consumption
PoE, IEEE 802.3af	12 W
12 V / 2 A	12 W

 **Warning**

- Do not connect any external power supply if PoE is used and vice versa.
- If you use a power adapter other than the recommended one, do not exceed the 12 V rated supply voltage. Also check the supply voltage polarity. Higher voltage values or misconnections may result in an irreplaceable device damage.

2.3 Installation Conditions

Make sure that the following 2N[®] Indoor Talk installation conditions are met:

- There must be enough space for the device installation.
- The device is designed for vertical wall mounting (perpendicular to the floor) in the height of up to 120 cm above the floor. If necessary, operate the device in a position other than as aforementioned for a short time only, for quick testing purposes in a servicing centre, for example.
- Exceeding the allowed operating temperature may not affect the device immediately but leads to premature ageing and lower reliability. Refer to S. 5. **Technical Parameters** for the acceptable range of operating temperatures and relative humidity values.
- The device is not designed for environments with increased vibrations such as means of transport, machine rooms and so on.
- The device is not intended for dusty environments and places with unstable humidity and abrupt temperature changes.
- The device may not be exposed to aggressive gas, acid vapours, solvents, etc.
- The device is not intended for direct connection into the Internet/WAN.
- The device must be connected to the Internet/WAN via a separating active network element (switch/router).
- The device is designed for indoor use. It may not be exposed to rain, flowing water, condensing moisture, fog, etc.
- The device cannot be operated on places exposed to direct sunshine and near heat sources.
- Keep some free space above and below the device to allow air to flow and conduct heat away.
- No strong electromagnetic radiance is allowed on the installation site.
- The VoIP connection must be configured properly according to the SIP and other VoIP recommendations.
- It is recommended that the power adapter be connected to the mains via a UPS and reliable overvoltage protection.

Power Supply Connection

You can feed 2N[®] Indoor Talk as follows:

1. Use a 12 V / 2 A DC power adapter connected to the backside terminal board.
2. Use an Ethernet cable connected to a PoE supply or PoE supporting Ethernet switch/router.

PoE Supply Connection

Use a standard straight RJ-45 terminated cable to connect **2N[®] Indoor Talk** to the Ethernet. The device supports the 10BaseT and 100BaseT protocols. The Ethernet connection state is indicated by the  symbol (hung-up receiver). If the symbol flashes, the device is disconnected from the network.

Caution

- Factory reset results in a change of the Ethernet interface configuration!
- A defective Ethernet cable may lead to a high packet loss in the Ethernet and subsequent instability and poor call quality!

Warning

- Do not connect an external power supply if PoE is used and vice versa.
- Connection of a defective or improper power supply may lead to a temporary or permanent device failure.

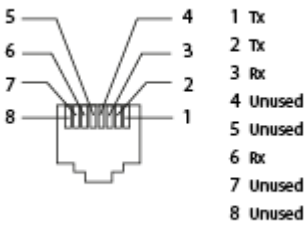
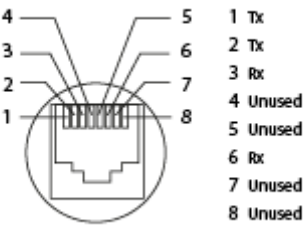
Ethernet cable connector	Ethernet socket
 <p> 5 4 1 Tx 6 3 2 Tx 7 2 3 Rx 8 1 4 Unused 5 Unused 6 Rx 7 Unused 8 Unused </p>	 <p> 4 5 1 Tx 3 6 2 Tx 2 7 3 Rx 1 8 4 Unused 5 Unused 6 Rx 7 Unused 8 Unused </p>

Firmware Upgrade

We recommend you to upgrade the **2N[®] Indoor Talk** firmware during installation. Refer to www.2n.cz for the latest FW version. Refer to **3.2.5 System** for the firmware upgrade procedure.

2.4 2N[®] Indoor Talk LAN Location via 2N[®] Network Scanner

2N[®] Indoor Talk is configured via the administration web server. Connect the device to the LAN IP and make sure it is properly powered.

2N[®] Network Scanner Description

The application helps find the IP addresses of all the 2N[®] Indoor Talk devices in the LAN. Download the app from the 2N web sites (www.2n.cz). Make sure that Microsoft .NET Framework 2.0 is installed for successful app installation.

1. Run the 2N[®] Network Scanner.
2. Use the Setup Wizard for successful installation.

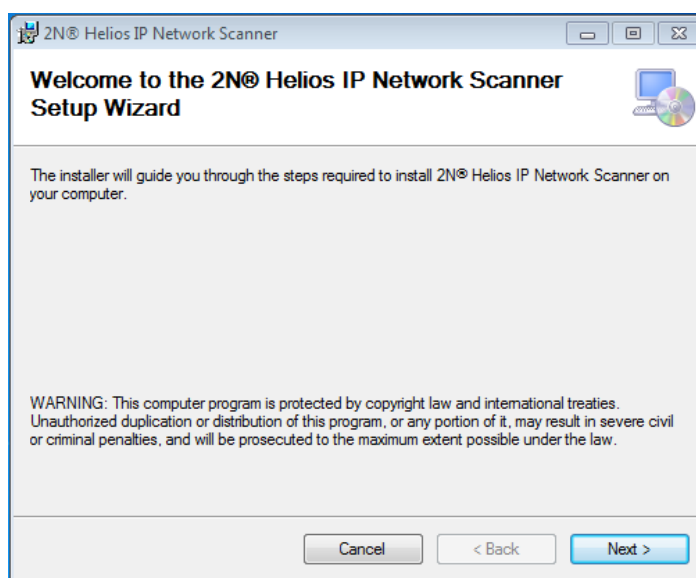

2N[®] IP Network Scanner Installer

3. Having installed the **2N[®] IP Network Scanner**, start the application using the Microsoft Windows Start menu.
4. Once started, the application begins to automatically search for all the **2N IP intercoms** in the LAN including their smart extensions (**2N[®] Indoor Talk**, **2N[®] Indoor Touch**), which are DHCP/statically assigned IP addresses. All the devices are displayed in a table.

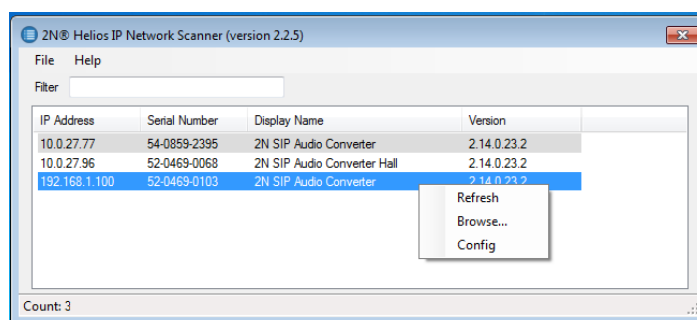

2N[®] IP Network Scanner Window

5. Select the **2N[®] Indoor Talk** device to be configured and right-click it. Select *Browse...* to open the **2N[®] Indoor Talk** administration web interface login window for configuration. To change the device IP address, select *Config* and enter the required static IP address or activate DHCP. The default configuration password is 2n. If the found device is grey highlighted, its IP address cannot be configured using this application. In that case, click Refresh to find the device again and check whether multicast is enabled in your network.

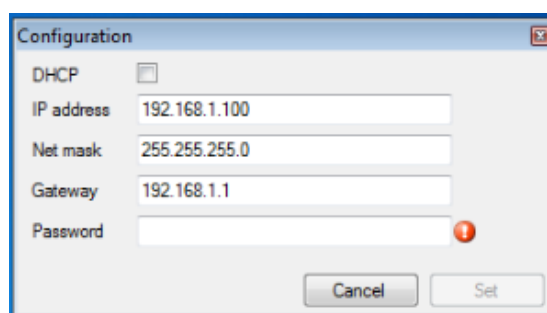

2N[®] IP Network Scanner IP Address Change

2.5 IP Address Lookup

IP Address Lookup

To look up the 2N[®] Indoor Talk IP address, take the following steps:

- Connect the device to the power supply (if connected, disconnect and reconnect it).
- Wait for the sound signal.
- Press the front panel lock button for 5 seconds within a 10s timeout.
- The device reads its IP address.
- If the address is 0.0.0.0, it means that the device has not obtained the IP address from the DHCP server.

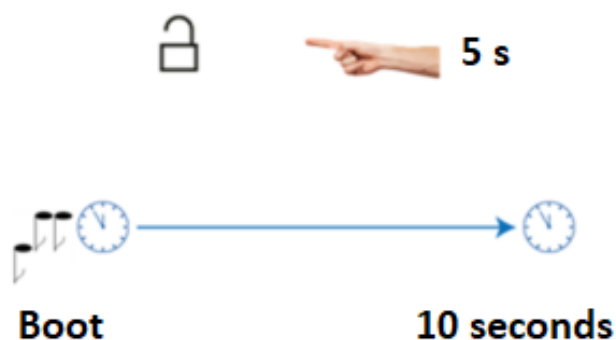

Note

- Press the button sequence within 30 seconds after the sound signal for security reasons. The pressing timeout is 2 s at most.

Dynamic/Static IP Address Switching

To switch the 2N[®] Indoor Talk dynamic/static IP address, take the following steps:

- Connect the device to the power supply (if connected, disconnect and reconnect it, or press Reset).
- Wait for the first sound signal.
- Press the front panel call hang-up button for 5 seconds within a 10s timeout.

- The switching is indicated with an audio message.
- The following options are available:
 - Static IP enabled: the static address has been enabled
 - DHCP enabled: obtaining the address from DHCP has been enabled

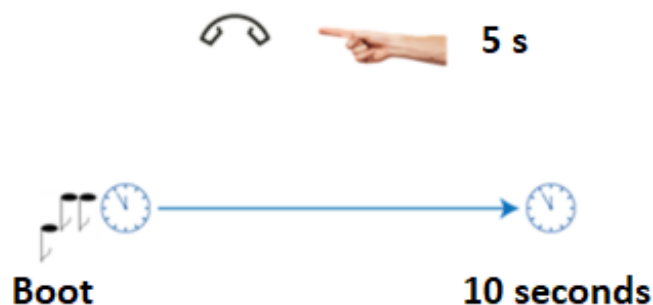

The following network parameters will be set after restart if the static IP address is enabled:

- IP address: 192.168.1.100
- Network mask: 255.255.255.0
- Default gateway: 192.168.1.1

If DHCP is enabled, DHCP will be activated after the message is played and the IP address will be played automatically when received by the device.

Note

- Press the button sequence within 10 seconds after the sound signal for security reasons.

3. Configuration

- 3.1 Factory Reset
- 3.2 Software Configuration

Login

Fill in the **2N[®] Indoor Talk** IP address or domain name into the internet browser to display the login screen. The default login user name and password are as follows:

- Username: **Admin**
- Password: **2n**

Should the login screen fail to appear, you must have typed a wrong IP address/port or the **2N[®] Indoor Talk** administration web server has been switched off. To find the correct IP address, use the **2N[®] Network Scanner** as described in **2.4 2N[®] Indoor Talk LAN Location via 2N[®] Network Scanner**.

Language Selection

Use the menu in the right-hand upper corner of the web interface to select a language.

2N Indoor Talk

CZ | EN | DE | FR | IT | ES | RU

Logout

Language Selection

3.1 Factory Reset

2N[®] Indoor Talk Restart

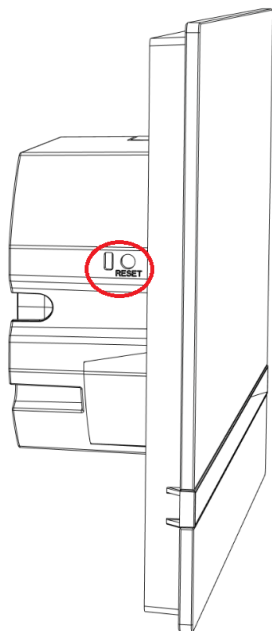

To **restart the device**, press Reset on the device back panel. The device is restarted in 10 seconds during which the device keeps shining and unresponsive to other button presses.

To **reset the factory default values**, take the following steps:

- Press and hold RESET.
- Wait until the red and green LEDs go on at the same time (approx. 20 s).
- Wait until the red LED goes off (approx. another 5 s).
- Wait until the green LED goes off and the red LED goes on again (approx. another 5 s).
- Wait until the red LED goes off (approx. another 5 s).
- Release RESET.

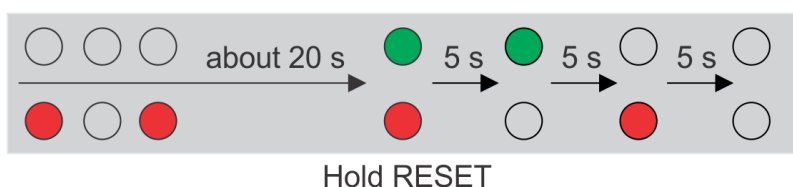



Caution

- All the user data will be deleted upon the factory reset.

3.2 Software Configuration

2N[®] Indoor Talk

Device Status

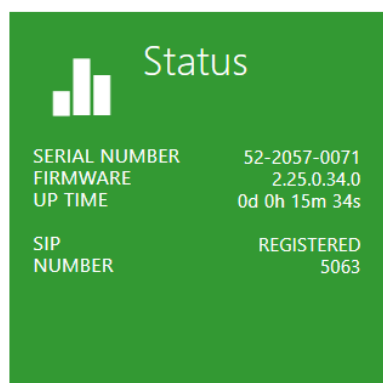

Status

SERIAL NUMBER 52-2057-0071
 FIRMWARE 2.25.0.34.0
 UP TIME 0d 0h 15m 34s

SIP NUMBER REGISTERED
 5063

Device Configuration

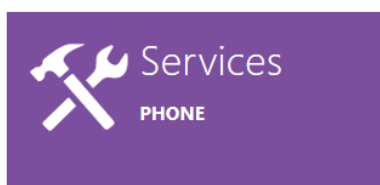

Services
PHONE

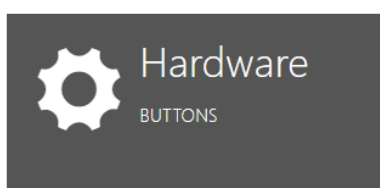

Hardware
BUTTONS

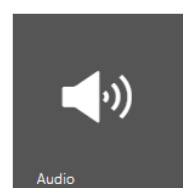

Audio



2N

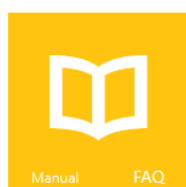

Manual FAQ

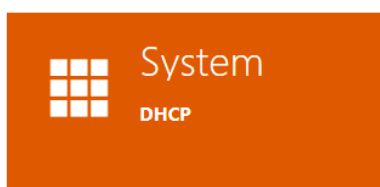

System
DHCP

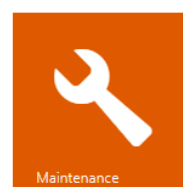

Maintenance

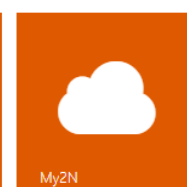

My2N

Start Screen

The start screen is displayed when you log in to the 2N[®] Indoor Talk web interface.

Use the back arrow  in the left-hand upper corner on each of the following web interface pages to return to this screen anytime. The screen header includes the device name (refer to the Display Name parameter in the **Services / Phone / SIP** menu). Select the web interface language with the buttons. Click the Log out button in the right-hand upper corner to log out.

The start screen also provides the first menu level and quick tile navigation to selected 2N[®] Indoor Talk configuration sections. Some tiles also display the states of selected services.

- 3.2.1 Status
- 3.2.2 Services
- 3.2.3 Hardware
- 3.2.4 System

3.2.1 Status

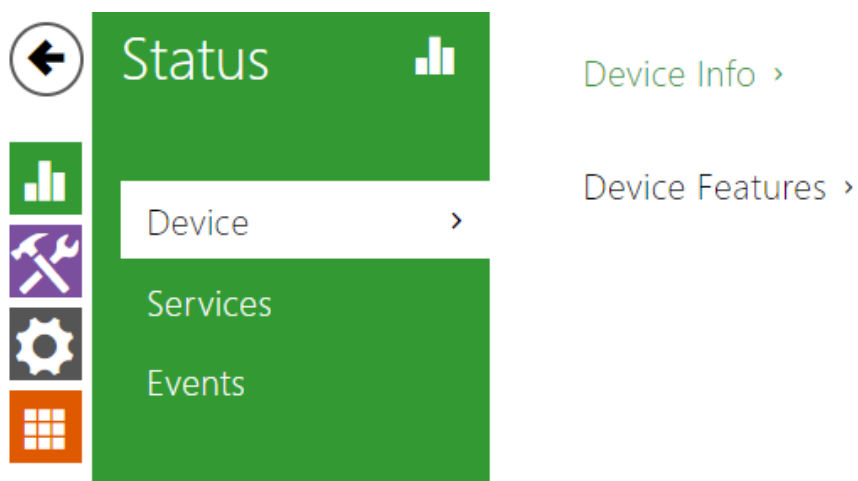

The **Status** menu provides a clear survey of the current device info and features in three tabs: **Device**, **Services** and **Events**.

- 3.2.1.1 Device
- 3.2.1.2 Services
- 3.2.1.4 Events

3.2.1.1 Device

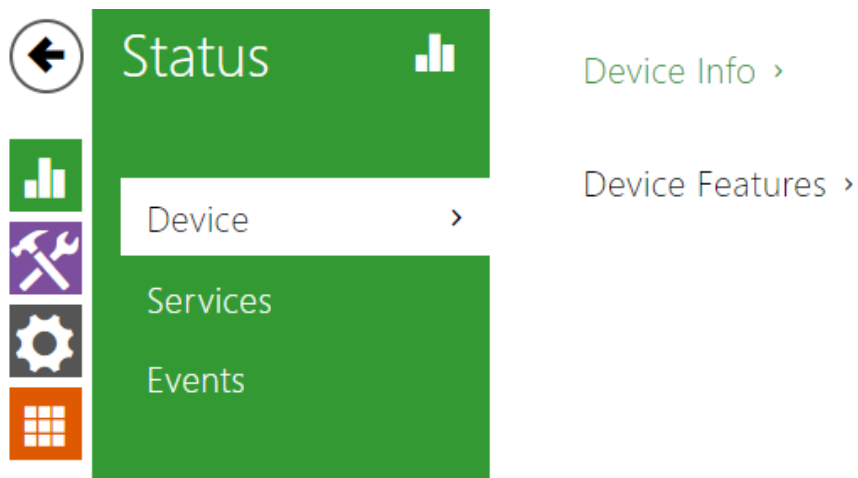

Device

The tab displays information on the model, its features, firmware and bootloader versions, etc.

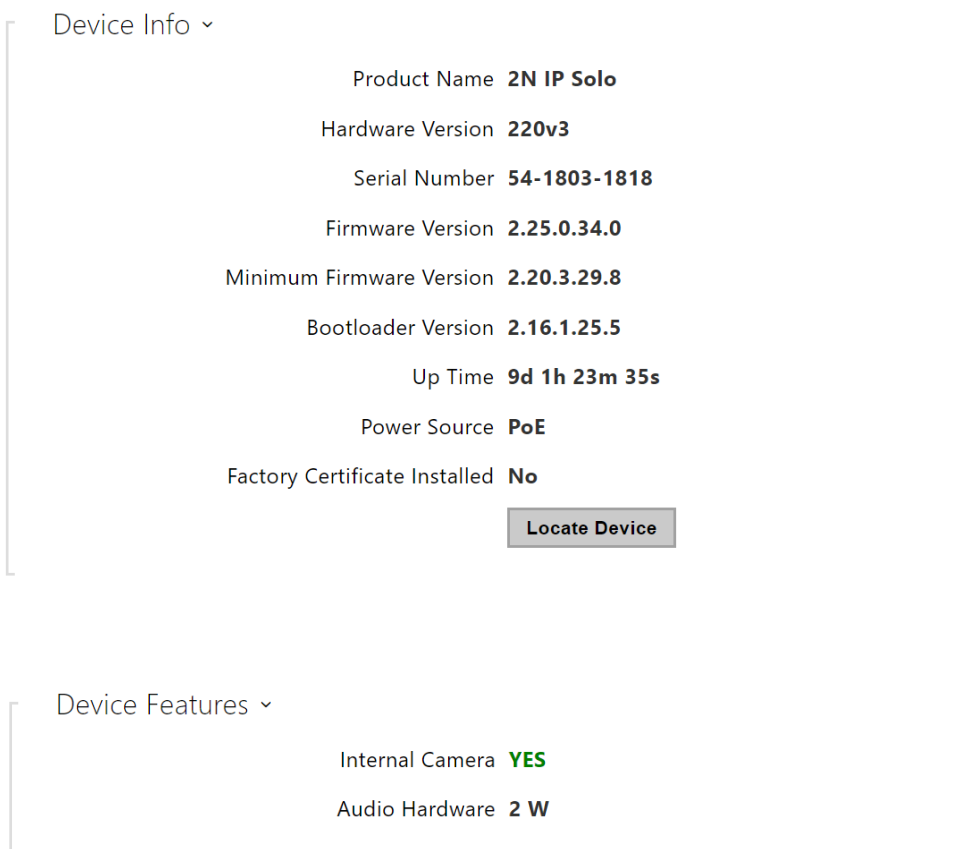

3.2.1.2 Services

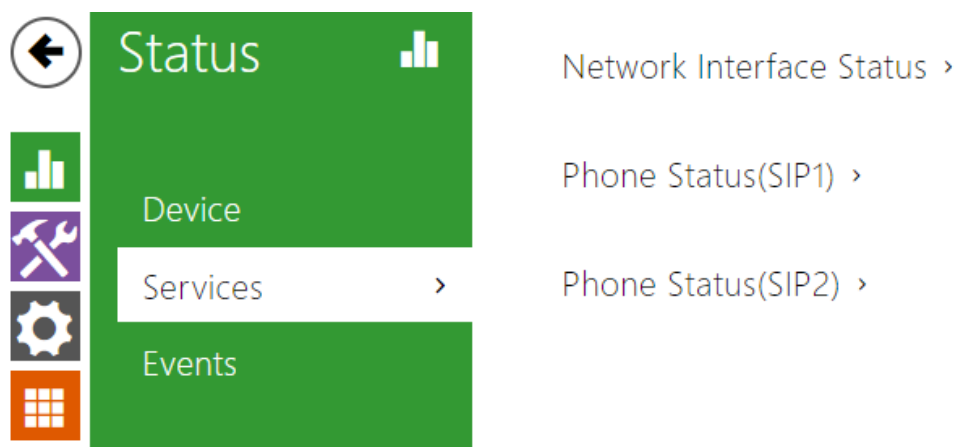

Services

The tab displays the states of the network interface and selected services.

<p>Network Interface Status ▾</p> <p>MAC Address 7C-1E-B3-02-B9-A0</p> <p>DHCP Status USED</p> <p>IP Address 10.0.25.170</p> <p>Network Mask 255.255.255.0</p> <p>Default Gateway 10.0.25.1</p> <p>Primary DNS 10.0.100.101</p> <p>Secondary DNS 10.0.100.102</p>
<p>Phone Status (SIP1) ▾</p> <p>Phone Number (ID) 4272</p> <p>Registration State REGISTERED</p> <p>Failure Reason -</p> <p>Registrar Address 10.0.97.150</p> <p>Last Registration Time 2018-10-04 13:30:28</p>

Phone Status (SIP2) ▾

Phone Number (ID) **111**

Registration State **NOT REGISTERED**

Failure Reason -

Registrar Address

Last Registration Time **N/A**

3.2.1.4 Events

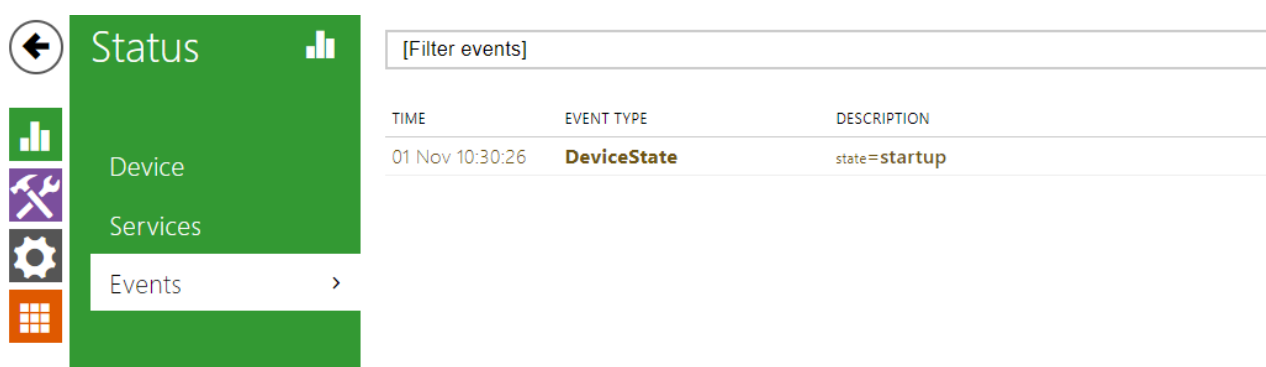

[Filter events]

TIME	EVENT TYPE	DESCRIPTION
01 Nov 10:30:26	DeviceState	state= startup

Events

The tab displays the last 500 events captured by the device. Every event includes the recording time and date, event type and detailed description. Use the pop-up menu above the event record to filter the events by the type.

[Filter events]

TIME	EVENT TYPE	DESCRIPTION
01 Jan 1:00:03	InputChanged	port= doorbell_button , state= true

3.2.2 Services

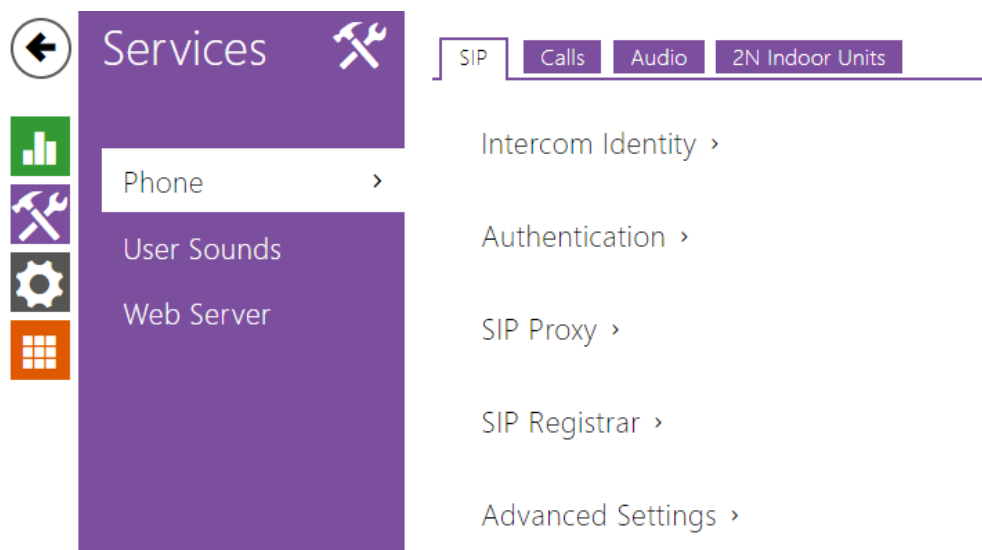

- 3.2.2.1 Phone
- 3.2.2.2 User Sounds
- 3.2.2.3 Web Server

3.2.2.1 Phone

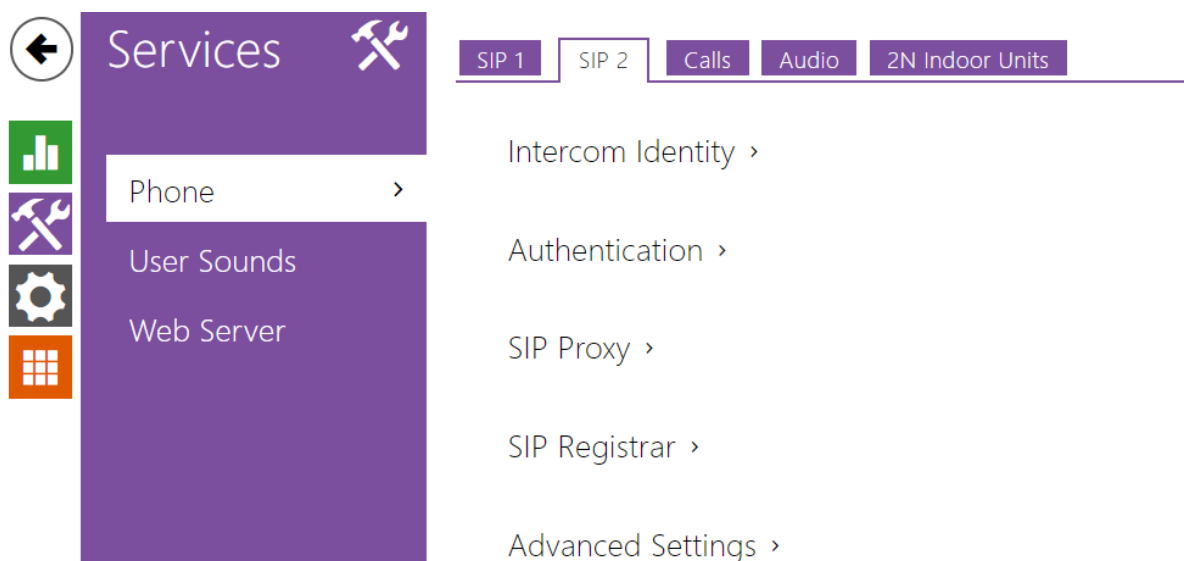

Phone is an essential function of **2N[®] Indoor Talk** allowing you to establish connections to other IP network terminals. **2N[®] Indoor Talk** supports the extended SIP.

Parameter List

2N[®] Indoor Talk Phone includes the following four tabs:

- **SIP 1** – complete SIP account settings.
- **Calls** – incoming and outgoing call settings.
- **Audio** – audio codec, DTMF and other audio stream parameter transmission settings.
- **LAN device** – general parameters and count of identified LAN devices.

SIP 1 and SIP 2

2N[®] Indoor Talk helps you configure one SIP account.

Intercom Identity ▾

Display Name	<input type="text" value="2N Indoor Talk"/>
Phone Number (ID)	<input type="text" value="111"/>
Domain	<input type="text" value="192.168.1.1"/>
	<input type="button" value="Test Call"/>

- **Display name** – set the name to be displayed on the called user's phone as CLIP.
- **Phone number (ID)** – set your device phone number (or another unique ID composed of characters and digits). Together with the domain, this number uniquely identifies the devices in calls and registration.
- **Domain** – set the domain name of the service with which the device is registered. Typically, it is identical with the SIP Proxy or Registrar address.
- **Test call** – display a dialogue window to make a test call to the selected phone number, see below.

Authentication ▾

Use Authentication ID	<input type="checkbox"/>
Authentication ID	<input type="text"/>
Password	<input type="password" value="....."/>

- **Use Authentication ID** – select the use of an alternative ID for authentication. Otherwise, the Phone number value from the previous section is used for authentication.
- **Authentication ID** – set the alternative user ID for device authentication.
- **Password** – set the authentication password. If your PBX requires no authentication, the parameter will not be applied.

SIP Proxy ▾

Proxy Address	<input type="text" value="192.168.1.1"/>
Proxy Port	<input type="text" value="5060"/>
Backup Proxy Address	<input type="text"/>
Backup Proxy Port	<input type="text" value="5060"/>

- **Proxy Address** – set the SIP Proxy IP address or domain name.
- **Proxy Port** – set the SIP Proxy port (typically 5060).
- **Backup Proxy Address** – set the backup SIP Proxy IP address or domain name to be used if the main Proxy fails to respond to requests.
- **Backup Proxy Port** – set the backup SIP Proxy port (typically 5060).

SIP Registrar ▾

Registration Enabled

Registrar Address

Registrar Port

Backup Registrar Address

Backup Registrar Port

Registration Expires [s]

Registration State **NOT REGISTERED**

Failure Reason -

- **Registration Enabled** – enable device registration with the set SIP Registrar.
- **Registrar Address** – set the SIP Registrar IP address or domain name.
- **Registrar Port** – set the SIP Registrar port (typically 5060).
- **Backup Registrar Address** – set the backup SIP Registrar IP address or domain name to be used if the main Proxy fails to respond to requests.
- **Backup Registrar Port** – set the backup SIP Registrar port (typically 5060).
- **Registration Expires** – set the registration expiry, which affects the network and SIP Registrar load by periodically sent registration requests. The SIP Registrar can alter the value without letting you know.
- **Registration State** – display the current registration state (Unregistered, Registering..., Registered, Registration terminated...).
- **Failure Reason** – display the cause of failure of the last registration attempt – the Registrar's last error response is displayed, e.g. 404 Not Found.

Advanced Settings ▾

SIP Transport Protocol	<input type="text" value="UDP"/>
Local SIP Port	<input type="text" value="5060"/>
PRACK Enabled	<input type="checkbox"/>
REFER Enabled	<input type="checkbox"/>
Send Keep Alive Packets	<input type="checkbox"/>
IP Address Filter Enabled	<input type="checkbox"/>
Receive encrypted calls only (SRTP)	<input type="checkbox"/>
Encrypted outgoing calls (SRTP)	<input type="checkbox"/>
Do not play incoming early media	<input type="checkbox"/>
QoS DSCP Value	<input type="text" value="0"/>
External IP Address	<input type="text"/>
Starting RTP Port	<input type="text" value="4900"/>
RTP Timeout	<input type="text" value="60"/>

- **SIP Transport Protocol** – set the SIP communication protocol: UDP (default), TCP and TLS.
- **Local SIP port** – set the local port for SIP signalling. A change of this parameter will not be applied until the device is restarted. The default value is 5060.
- **PRACK Enabled** – enable the PRACK method (reliable confirmation of SIP messages with codes 101–199).
- **REFER Enabled** – enable call forwarding via REFER.
- **Send Keep Alive Packets** – set that the device shall inquire periodically about the state of the called station via SIP OPTIONS requests during the call (used for station failure detection during the call).
- **IP Address Filter Enabled** – enable blocking of SIP packet receiving from addresses other than the SIP Proxy and SIP Registrar ones. Primarily used for higher communication security and preventing unauthorised phone calls.
- **Receive encrypted calls only (SRTP)** – set that SRTP encrypted calls shall only be received on this account. Unencrypted calls shall be rejected. At the same time, TLS is recommended as the SIP transport protocol for higher security.
- **Encrypted outgoing calls (SRTP)** – set that outgoing calls shall be SRTP encrypted on this account. At the same time, TLS is recommended as the SIP transport protocol for higher security.
- **Do not play incoming early media** – disable playing of the incoming audio stream before the call sent by some PBXs or other devices is picked up (early media). A standard local ringtone is played instead.
- **QoS DSCP Value** – set the SIP packet priority in the network. The set value is sent in the TOS (Type of Service) field in the IP packet header. Enter the value as a decimal number. The change will be applied after the device restart.

- **External IP Address** – set the public IP address or router name to which the device is connected. If the device IP address is public, leave this parameter empty.
- **Starting RTP Port** – set the initial local RTP port in the range of 64 ports used for audio and video transmission. The default value is 4900 (i.e. the range is 4900–4963). The parameter is shared by both the SIP accounts and is set for account 1 only.
- **RTP Timeout** – set the audio stream RTP packet receiving timeout during the call. If this limit is exceeded (RTP packets are not delivered), the call will be terminated by the device. Enter 0 to disable this parameter. The parameter is shared by both the SIP accounts and is set for account 1 only.

Calls

General Settings ▾

Call Time Limit [s]

- **General Settings** – set the call duration limit after which the call is automatically terminated. The intercom signals termination with a beep 10 s before the call end. Enter any DTMF character into the call (# on your IP phone, e.g.) to extend the call time.

Incoming Calls ▾

Call Answering Mode (SIP1) ▾

Call Answering Mode (SIP2) ▾

Pick up in [s]

Time Limited DND Mode ▾

- **Call Answering Mode (SIP1, SIP2)** – set the way of receiving incoming calls. The following three options are available:
 - **Always busy** – the device rejects incoming calls.
 - **Manual answering** – the device signals incoming calls by ringing and the user can answer the call using a numeric keypad.
 - **Automatic** – the device picks up incoming calls automatically. You can set the call receiving mode for each SIP account separately.
- **Pick up in** – this parameter is only active when the Automatic parameter pickup mode is enabled. The call is picked up automatically after the preset timeout.
- **Time Limited DND Mode** – disable ringing for a limited time. If this temporary silent mode is activated, the 2N IP intercom shall not ring when a call comes until timeout.

Outgoing Calls ▾

Ring Time Limit [s]

- **Ring Time Limit** – set the maximum call setup and ringing time in which all outgoing calls are automatically terminated. If the calls are routed to the GSM network via GSM gateways, you are advised to set a value longer than 20 s. Minimum value: 1 s, maximum value: 600 s. Set 0 to disable the time parameter.

Audio

Audio Codecs ▾

CODEC	ENABLED	PRIORITY
PCMU	<input checked="" type="checkbox"/>	<input type="text" value="2"/>
PCMA	<input checked="" type="checkbox"/>	<input type="text" value="3"/>
L16/16kHz	<input type="checkbox"/>	<input type="text" value="4"/>
G.729	<input type="checkbox"/>	<input type="text" value="5 (lowest)"/>
G.722	<input checked="" type="checkbox"/>	<input type="text" value="1 (highest)"/>

- Enable/disable the audio codecs offered for call setup and set their priorities.

The tab below helps you define how DTMF characters shall be sent from the intercom. Check the DTMF receiving options and settings of the opponent to make the function work properly.

DTMF Sending ▾

In-Band (Audio)

RTP (RFC-2833)

SIP INFO (RFC-2976)

- **In-Band (Audio)** – enable the classic method of sending DTMF in the audio band using standardised dual tones.
- **RTP (RFC-2833)** – enable sending DTMF via the RTP according to RFC-2833.
- **SIP INFO (RFC-2976)** – enable sending DTMF via SIP INFO messages according to RFC-2976.

The tab below helps you define how DTMF characters shall be received from the intercom. Check the DTMF receiving options and settings of the opponent to make the function work properly.

DTMF Receiving ▾

In-Band (Audio)

RTP (RFC-2833)

SIP INFO (RFC-2976)

- **In-Band (Audio)** - enable classic DTMF dual tone receiving in the audio band.
- **RTP (RFC-2833)** - enable DTMF receiving via the RTP according to RFC-2833.
- **SIP INFO (RFC-2976)** - enable DTMF receiving via SIP INFO messages according to RFC-2976.

Transmission Quality Settings ▾

QoS DSCP Value

Jitter Compensation

- **QoS DSCP value** - set the audio RTP packet priority in the network. The set value is sent in the TOS (Type of Service) field in the IP packet header.
- **Jitter Compensation** - set the buffer length for compensation of interval unevenness in audio packet arrivals. Set a higher value to increase the receiving immunity at the cost of a higher sound delay.

2N Indoor Units

General Settings ▾

Device Name

Group Access Key

- **Device Name** - set the device name to be displayed in the list of detected devices in all the devices in one and the same LAN. By setting the user phone number on a device to device:device_name you can direct the call to the 2N answering unit.
- **Group Access Key** - set the access key to be shared by the 2N answering unit and the intercoms. If the keys in the 2N answering unit and the intercoms fail to match, the devices cannot communicate, i.e. the intercom cannot call the 2N answering unit and vice versa.

Detected intercoms ▾

Count of detected intercoms **3**

Display the list of detected intercoms

- **Count of detected intercoms** - display the current count of intercoms detected in your LAN.
- **Display the list of detected intercoms** - display the list of registered devices.

3.2.2.2 User Sounds

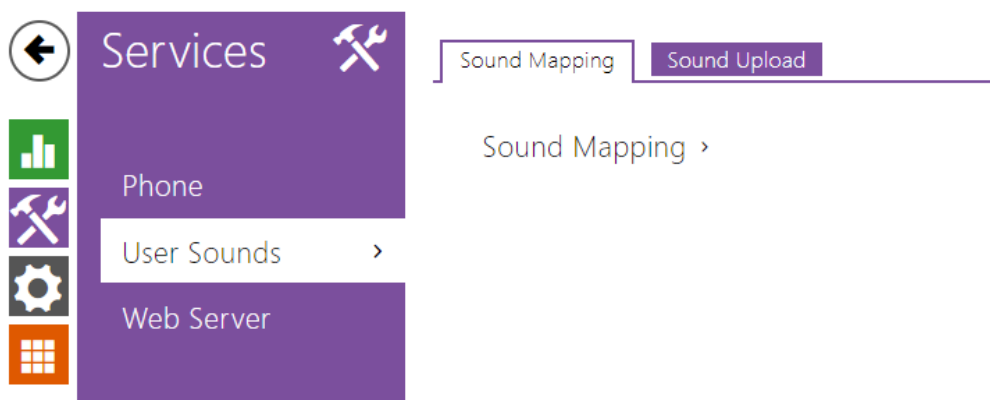

2N[®] Indoor Talk signals variable operational statuses with a sequence of tones. If standard signalling tones do not meet your requirements, you can modify them.

The device allows you to modify sound signalling for the following states:

1.
 - a. Ringtone before call pickup
 - b. Ringing tone
 - c. Busy tone
 - d. Call end signalling
 - e. Doorbell

Sound Mapping

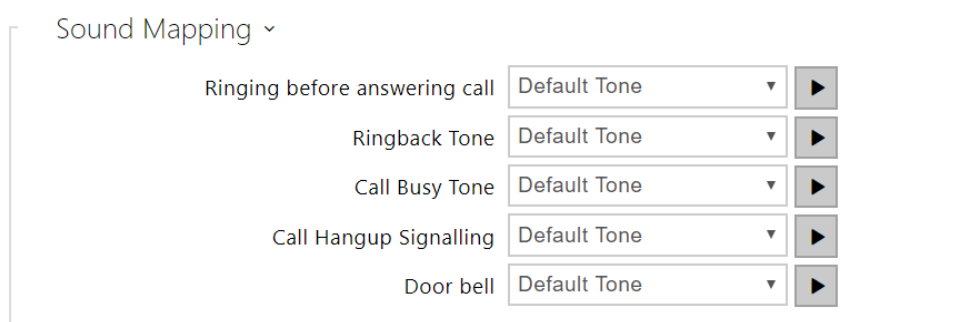

- **Ringtone before answering call** – set the ringtone to be played before an incoming call is picked up (device ringtone).
- **Ringback Tone** – set the tone to be played while the phone is ringing that called user's. The PBX ringing tone is preferred to the user ringing tone in the device.

- **Call Busy Tone** - set the tone to be played when the called user is busy.
- **Call Hangup Signalling** - set the tone to signal the call end.
- **Door bell** - set the tone to be played when the doorbell is used.

Sound Upload

Sound Upload ▾

	NAME	SIZE				
1	<input type="text" value="User sound 1"/>	N/A				
2	<input type="text" value="User sound 2"/>	N/A				
3	<input type="text" value="User sound 3"/>	N/A				
4	<input type="text" value="User sound 4"/>	N/A				
5	<input type="text" value="User sound 5"/>	N/A				
6	<input type="text" value="User sound 6"/>	N/A				
7	<input type="text" value="User sound 7"/>	N/A				
8	<input type="text" value="User sound 8"/>	N/A				
9	<input type="text" value="User sound 9"/>	N/A				
10	<input type="text" value="User sound 10"/>	N/A				

You can load up to 10 user sound files to the device and name each of them for better orientation.

Press to load a sound file to the device. Select a file from your PC and click **Load**. Press to remove a file. Click to play a successfully loaded sound file (locally on your PC). Press to record a sound file via your PC microphone.

3.2.2.3 Web Server

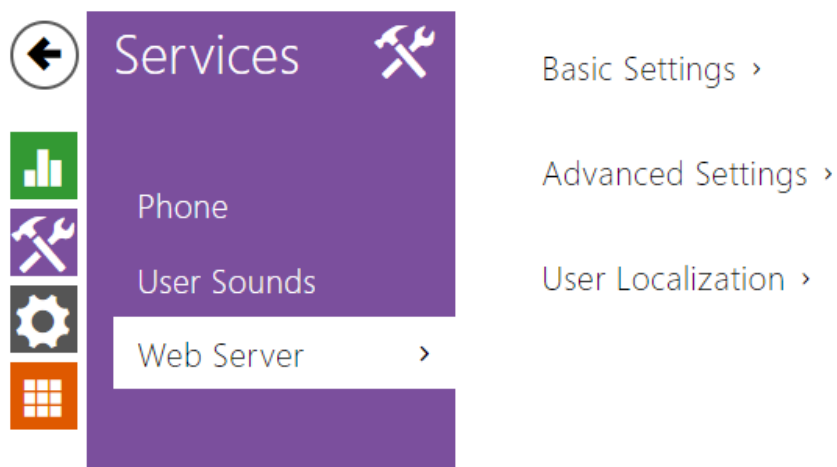

2N[®] Indoor Talk can be configured using a common browser that approaches the web server integrated in the device. The HTTPS protocol is used for the browser - device communication. Enter the login user name and password first. The default values are **admin** and **2n** respectively. We recommend to you change the default password as soon as possible.

Parameter List

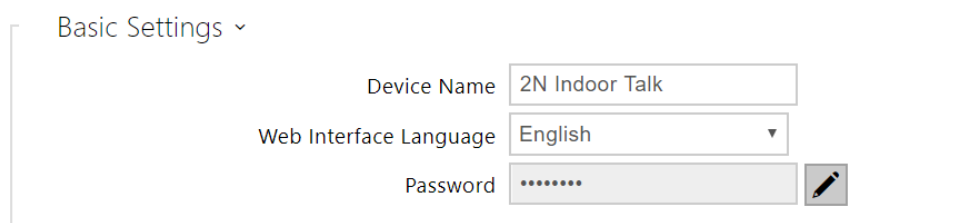

The screenshot shows the 'Basic Settings' configuration page. It contains three main fields: 'Device Name' with the value '2N Indoor Talk', 'Web Interface Language' with a dropdown menu set to 'English', and 'Password' with a masked field of seven dots and an edit icon (pencil) to its right.





- **Device Name** - set the device name to be displayed in the right-hand upper corner of the web interface, in the login window and in other applications if necessary (Network Scanner, etc.)
- **Web Interface Language** - set the default language for administration web server login. Use the upper toolbar buttons to change the web interface language temporarily any time.
- **Password** - set the device login password. Click  to edit the password. make sure that the password contains 8 characters at least, including one small alphabet letter, one capital alphabet letter and one digit.

Advanced Settings ▾

HTTP Port	<input type="text" value="80"/>
HTTPS Port	<input type="text" value="443"/>
Minimum Allowed TLS Version	<input type="text" value="TLS 1.0"/> ▾
HTTPS User Certificate	<input type="text" value="Self Signed"/> ▾
Remote Access Enabled	<input checked="" type="checkbox"/>

- **HTTP port** – set the web server port for insecure HTTP communication. The port change will not be applied until the device is restarted.
- **HTTPS port** – set the web server port for secure HTTPS communication. The port change will not be applied until the device is restarted.
- **Minimum Allowed TLS Version** – define the lowest TLS version to be connected to the devices.
- **HTTPS User Certificate** – set the user certificate and private key for communication encryption between the device HTTP server and the user web browser. Choose one of the available user certificate and private key sets, refer to the Certificates subsection, or keep the **Self Signed** setting, in which a certificate generated automatically upon the first startup is used.
- **Remote Access Enabled** – enable remote access to the web server from IP address beyond the LAN.

User Localization ▾

FILE	SIZE	
Original Language	187 kB	
Custom Language	N/A	  

- **Original Language** – download an original file from the device including all user interface texts in English. The file format is XML, see below.
- **User Language** – upload or remove user files including translations of the user interface texts.

3.2.3 Hardware

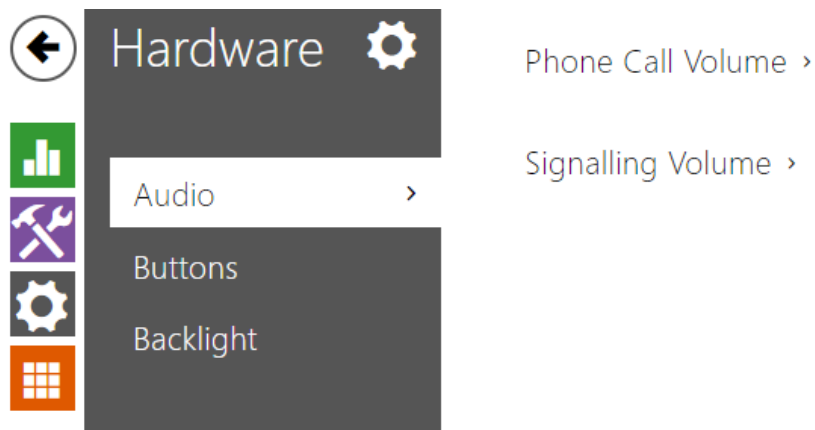

The **Audio** menu displays clearly the current audio information and audio features.

- 3.2.3.1 Audio
- 3.2.3.2 Buttons
- 3.2.3.3 Backlight

3.2.3.1 Audio

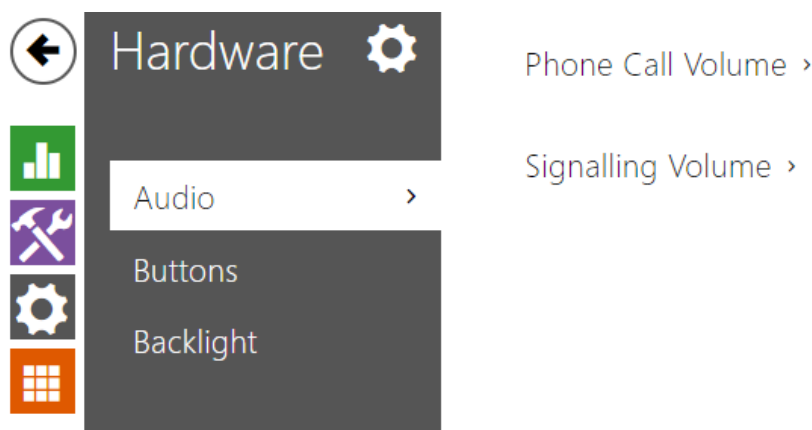

2N[®] Indoor Talk is equipped with a speaker. This configuration section helps you set the phone call volume and state signalling volume. **Master volume** controls the general device volume including call volume, signalling tone volume, and so on. Consider the noise level of the ambient environment while setting this parameter.

Parameter List

Phone Call Volume ▾

Phone Call Volume	+4 dB ▾
Ringtone Volume	-8 dB ▾
Call-Progress Tone Volume	0 dB ▾

- **Phone Call Volume** – set the phone call volume.
- **Ringtone Volume** – set the incoming call ringing volume.
- **Call-Progress Tone Volume** – set the dial, ring and busy tone volume. In case the call-progress tones are automatically generated by the PBX, this setting will not be applied.

Signalling Volume ▾

Enable beep at keystroke	<input checked="" type="checkbox"/>
Key Beep Volume	0 dB ▾
Warning Tone Volume	0 dB ▾
Suppress Warning Tones	<input type="checkbox"/>
User Sounds Volume	0 dB ▾

- **Enable beep at keystroke** – enable touch panel keystroke beep signalling
- **Key Beep Volume** – set the key beep volume. The volume values are relative against the set master volume.
- **Warning Tone Volume** – set the volume of warning and signalling tones described in the Signalling of Operational Statuses section. The volume values are relative against the set master volume.
- **Suppress Warning Tones** – suppress signalling of the following operational states. Internal application started, IP address received and IP address lost.
- **User sound volume** – set the volume of user sounds. The volume values are relative against the set master volume.

3.2.3.2 Buttons

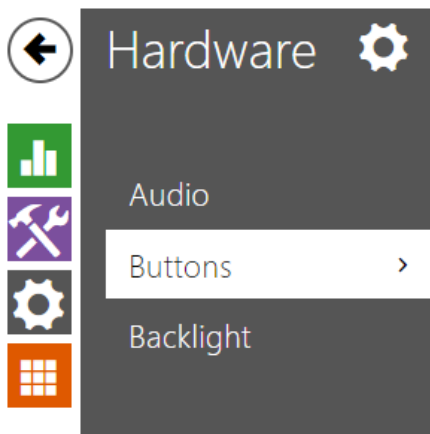

Call Destinations >

Unlock Settings >

Set the call destinations and unlocking on this tab.

Call Destinations ▾

Short Call Button Press

Phone Number

1. Code

2. Code

Long Call Button Press

Phone Number

1. Code

2. Code

Short Call Button Press

- **Phone Number** – enter the station phone number or 2N IP intercom name in the format device:device_name. Refer to the list of detected intercoms in the Services/Phone/2N Indoor Units for the device_name.
- **1st and 2nd Code** – this code is sent when a call is set up with this phone number and the Unlock button is pressed for a long time.

Long Call Button Press

- **Phone Number** – enter the station phone number or 2N IP intercom name in the format device:device_name. Refer to the list of detected intercoms in the Services/Phone/2N Indoor Units for the device_name.
- **1st and 2nd Code** – this code is sent when a call is set up with this phone number and the Unlock button is pressed for a long time.

Unlock Settings ▾

Default Unlock Code

Hang up after door unlocking

Hang-up delay [s]

- **Default Unlock Code** – this code is sent when no call is set up with any of the given phone numbers and/or no Unlock short/long press codes are set.
- **Hang up after door unlocking** – hang up after the door unlocking request is sent successfully.
- **Hang-up delay** – hang up when this timeout passes after the door unlocking request is sent successfully.

3.2.3.3 Backlight

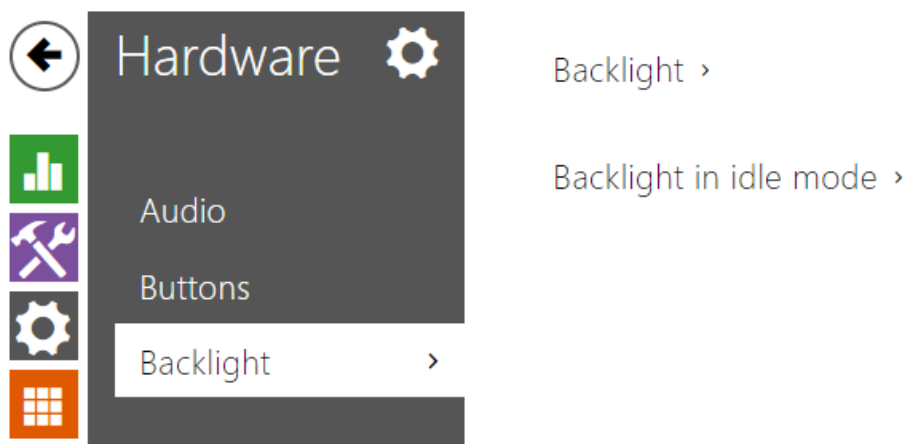

Set the backlight level separately on this tab.



- **Intensity** – set the backlight intensity value in per cent of the maximum possible LED brightness.

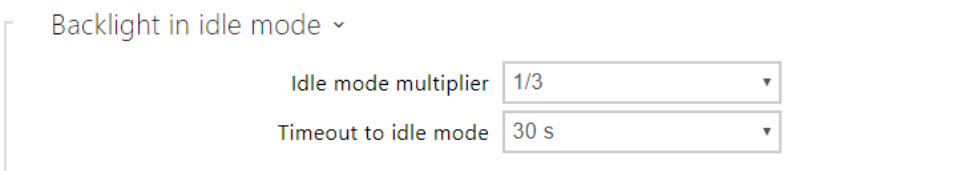

- **Idle mode multiplier** – backlight level multiplier used when the device goes into idle mode.
- **Timeout to idle mode** – time of inactivity after which the device enters idle mode.

Note

- The brightness level considerably affects the functionality, consumption and general appearance of the device. A high backlight value may dazzle the person standing in front of the device if the ambient light is low and also increases the overall device consumption.

3.2.4 System

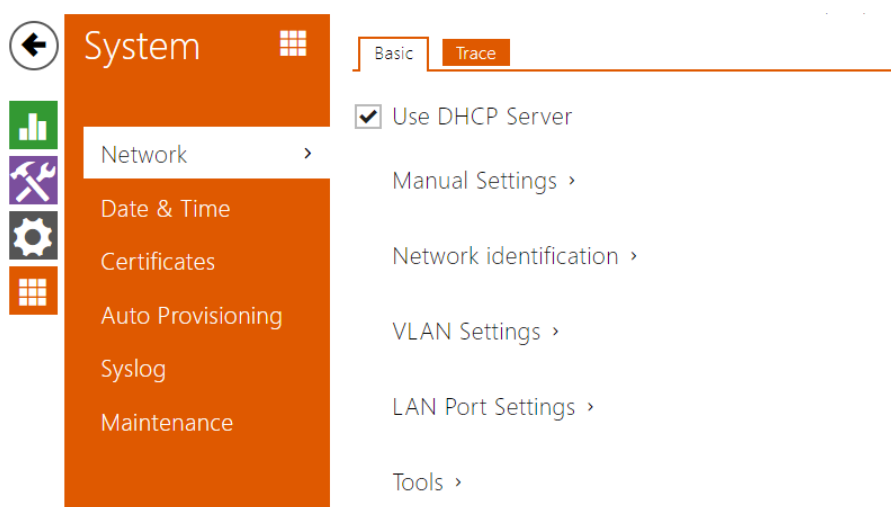

Here is what you can find in this subsection:

- 3.2.4.1 Network
- 3.2.4.2 Date and Time
- 3.2.4.3 Certificates
- 3.2.4.4 Auto Provisioning
- 3.2.4.5 Syslog
- 3.2.4.6 Maintenance

3.2.4.1 Network

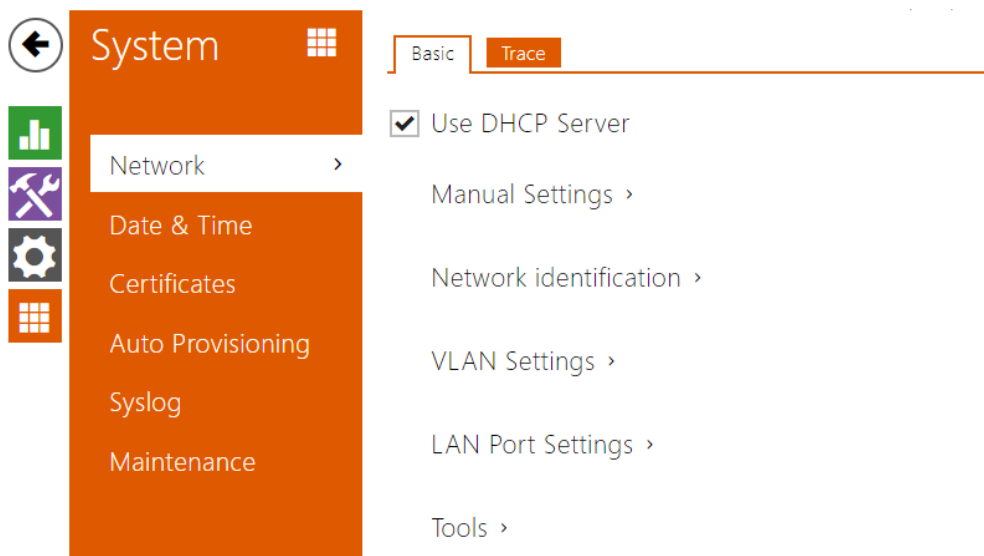

2N[®] Indoor Talk is connected to the LAN and has to be assigned a valid IP address or obtain the IP address from the LAN DHCP server. The Network section helps you configure the IP address and DHCP.

Tip

- To loop up the 2N[®] Indoor Talk IP address, apply the 2N[®] Network Scanner, which can be downloaded freely from www.2n.cz, and use the mechanism described in 2.4 2N[®] Indoor Talk LAN Location via 2N[®] Network Scanner.

Parameter List

Network

Basic

Use DHCP Server

- **Use DHCP server** – enable automatic obtaining of the IP address from the LAN DHCP server. If there is no DHCP server or the DHCP cannot be used in your network, use the manual network setting.

Manual Settings ▾

Static IP Address	<input type="text" value="192.168.1.100"/>
Network Mask	<input type="text" value="255.255.255.0"/>
Default Gateway	<input type="text" value="192.168.1.1"/>
Primary DNS	<input type="text"/>
Secondary DNS	<input type="text"/>

- **Static IP address** – static IP address of the device. The address is used together with the parameters below unless Use DHCP server is enabled.
- **Network Mask** – network mask setting.
- **Default Gateway** – default gateway address for off-LAN communication.
- **Primary DNS** – primary DNS address for domain name-to- IP address translation.
- **Secondary DNS** – secondary DNS address where the primary DNS is unavailable.

Network Identification ▾

Hostname	<input type="text" value="2NIndoorTalk-5219580009"/>
Vendor Class Identifier	<input type="text"/>

- **Hostname** – set the device LAN identification.
- **Vendor Class Identifier** – set the Vendor Class Identifier – character string to be passed in the DHCP Option 60.

VLAN Settings ▾

VLAN Enabled

VLAN ID

- **VLAN Enabled** – enable the virtual network support (VLAN according to 802.1q). Remember to set the VLAN ID too.
- **VLAN ID** – choose a VLAN ID from the range of 1–4094. The device shall only receive packets with the set ID. An incorrect setting may result in a connection loss and subsequent factory reset.

LAN Port Settings ▾

Required Port Mode

Current Port State **Full Duplex - 100mbps**



- **Required Port Mode** – set the LAN port mode to be preferred: Automatic or Half Duplex – 10 Mbps, which reduces the bit rate to 10 Mbps in case the available LAN cabling is unreliable for a 100 Mbps traffic.
- **Current Port State** – current LAN port state: Half or Full Duplex – 10 Mbps or 100 Mbps.

Tools ▾

Verify the network address accessibility

Verify the network address accessibility – check the accessibility of a given address in the LAN via the Ping command like in common operating systems. Press Ping to display a dialogue for you to enter the IP address/domain name and press Ping to send the test data to the set address. If the IP address/domain name is invalid, a warning is displayed and the Ping button remains inactive until the IP address becomes valid. The dialogue also displays the procedure state and result. Failed means that either the IP address was unavailable within 10 s or it was impossible to translate the domain name into an address. If a valid response is received, the response sending IP address and response waiting time in milliseconds are displayed. Press Ping again to send another query to the same address.

Trace

The Trace tab helps you trigger capturing of incoming and outgoing packets via the **2N[®] Indoor Talk** LAN interface. The captured packets are stored in a 4 MB buffer. When the buffer storage capacity is full, the oldest packets are rewritten automatically. You are recommended to keep the video stream bit rate below 512 kbps while capturing packets. Press  to start capturing, click  to stop capturing and press  to download the captured packet file.



Packet Capture Status ▾

Current State **RUNNING**

Buffer Size **4096 kB**

Buffer Utilisation **4096 kB**

Number of Captured Packets **22966**

Packet Capture Control   

3.2.4.2 Date and Time

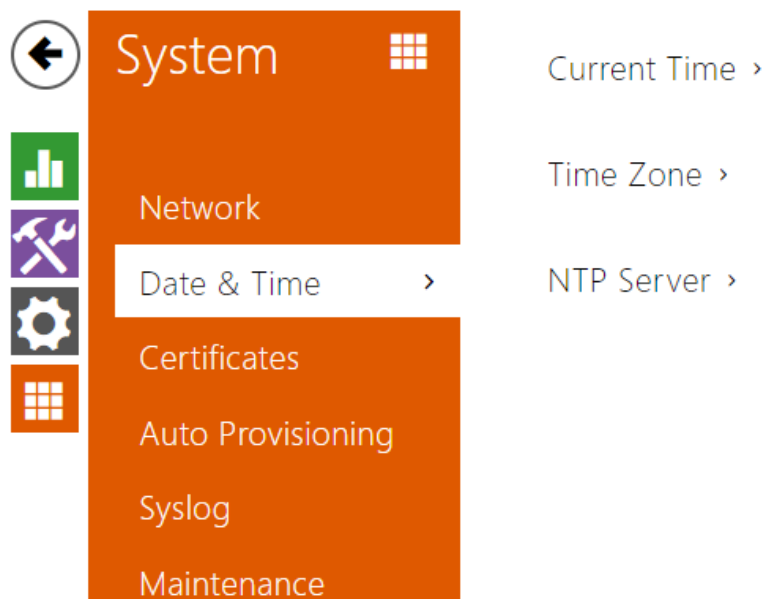

2N[®] Indoor Talk is equipped with a real time clock to back up the device for even a few days in case of power outage. Click **Synchronise** to synchronise your 2N[®] Indoor Talk time with your PC time value any time.

Time in 2N[®] Indoor Talk can be synchronised with any available SNTP server.

Note

- *A correct date/time value is unnecessary for the basic function of 2N[®] Indoor Talk but crucial for a proper function of time profiles and correct time displays of events in such lists as Syslog, Entered cards, Logs downloaded via HTTP API, etc.*

In standard operational conditions, the 2N[®] Indoor Talk real time circuit accuracy is $\pm 0.005\%$, which may represent an error of up to ± 2 minutes per month.

Parameter List

Current Time ▾

Current Device Time **03/23/2018 08:01:38**

Synchronise with browser

- **Synchronise with browser** – click the button to synchronise the device time with your current PC time value.

Time Zone ▾

Time Zone

Time Zone Rule

- **Time Zone** – set the time zone for your installation site to configure time shifts and summer/winter time transitions.
- **Time Zone Rule** – set the time zone rule manually if your device is installed on a site that is not included in the Time zone list. The time zone rule is only applied if the Time zone parameter is set to **Manual settings**.

NTP Server ▾

Use NTP Server

NTP Server Address

NTP Time Status **Synchronised**

- **Use NTP Server** – enable the use of the NTP server for internal time synchronisation.
- **NTP Server Address** – set the IP address/domain name of the NTP server used for the device internal time synchronisation.
- **NTP Time State** – display the state of the last local time synchronisation attempt via NTP: Unsynchronised. Synchronised, Error.

3.2.4.3 Certificates

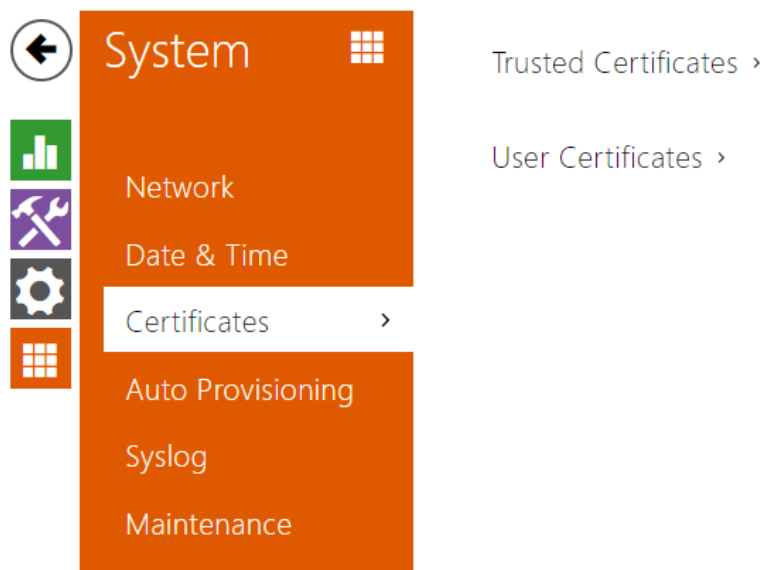

Some 2N[®] Indoor Talk LAN services use the secure TLS protocol for communication with the other LAN devices. This protocol prevents third parties from eavesdropping on or modifying call contents. TLS is based on one/two-sided authentication, which requires certificates and private keys.

2N[®] Indoor Talk services that use TLS:

1.
 - a. Web server (HTTPS)
 - b. E-mail (SMTP)
 - c. 802.1x (EAP-TLS)
 - d. SIPs

2N[®] Indoor Talk allows you to download up to 3 sets of certificates from certification authorities, which help you authenticate the communicating device, and also 3 user certificates and private keys for encryption purposes.

Each certificate requiring service can be assigned one certificate set, refer to **Web Server**, **E-mail** and **Streaming**. The certificates can be shared by multiple services.

2N[®] Indoor Talk accepts the DER (ASN1) and PEM certificates.







Once powered, 2N[®] Indoor Talk generates automatically the so-called **Self Signed certificate** and a **private key**, which can be used for the **Web server** and **E-mail** services without the need to load a unique certificate and private key.

Note







- If you use the Self Signed certificate for encryption, the 2N[®] Indoor Talk web server - browser communication is secure, but the browser notifies you that it cannot authenticate the 2N[®] Indoor Talk certificate.



Refer to the two tables below for the current list of loaded certificates from certification authorities and user certificates:

Trusted Certificates ▾

CA IDENTITY	ISSUER	EXPIRY TIME		
(1)				
(2)				
(3)				

User Certificates ▾

CA IDENTITY	ISSUER	EXPIRY TIME		
(1)				
(2)				
(3)				

Press  to download a certificate from your PC to the device. Select the certificate (or private key) file in a dialogue window and click **Load**. Press  to remove a certificate from 2N[®] Indoor Talk.

Note

Note that a certificate with a private RSA key longer than 2048 bits may be rejected and the following message appears:

The private key file or password has not been accepted by the device!

3.2.4.4 Auto Provisioning

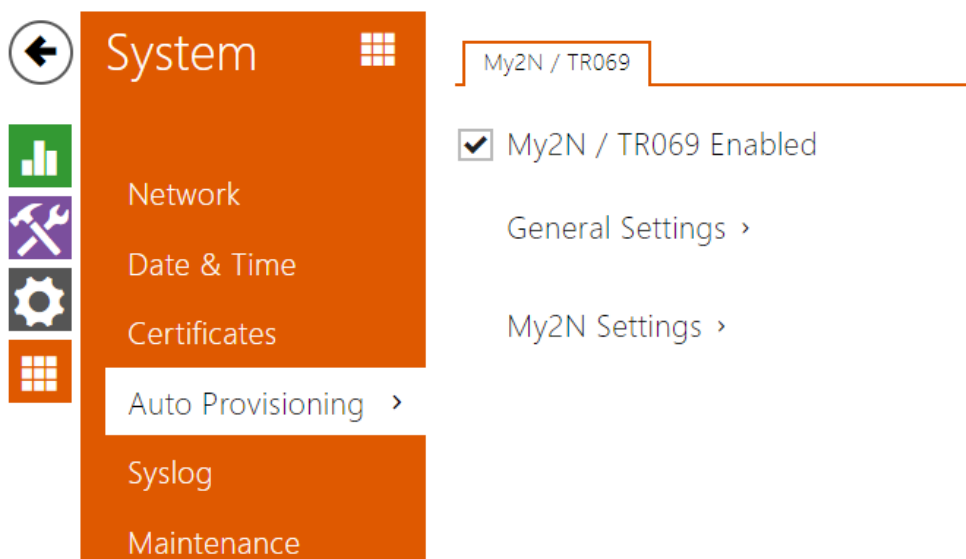

The **2N[®] Indoor Talk** help you update firmware and configuration manually, or automatically from a storage on a TFTP/HTTP server selected by you according to predefined rules.

You can configure the TFTP and HTTP server address manually. The **2N[®] Indoor Talk** support automatic identification of the local DHCP server address (Option 66).

My2N / TR069

Use this tab to enable and configure remote device management via the TR-069 protocol. TR-069 helps you reliably configure device parameters, update and back up configuration and/or upgrade device firmware.

The TR-069 protocol is utilised by the My2N cloud service. Make sure that TR-069 is enabled and Active profile set to My2N to make your intercom log in to My2N periodically for configuration.

This function helps you connect the device to your ACS (Auto Configuration Server). In this case, the connection to My2N will be disabled in the device.

My2N / TR069 Enabled

- **My2N / TR069 Enabled** - enable connection to My2N or another ACS server.

General Settings ▾

Active Profile

Next synchronisation in **10h 20m 36s**

Connection Status **Synchronised**

Communication Status Detail **HTTP status: 204, No Content.**

- **Active profile** – select one of the pre-defined profiles (ACS), or choose a setting of your own and configure the ACS connection manually.
- **Next synchronisation in** – display the time period in which the device shall contact a remote ACS.
- **Connection status** – display the current ACS connection state or error state description if necessary.
- **Communication Status Detail** – server communication error code or HTTP status code.
- **Connection test** – test the TR069 connection according to the set profile, see the Active profile. The test result is displayed in the Connection status.

My2N Settings ▾

My2N ID

- **My2N ID** – unique identifier of the company created via the My2N portal.

3.2.4.5 Syslog

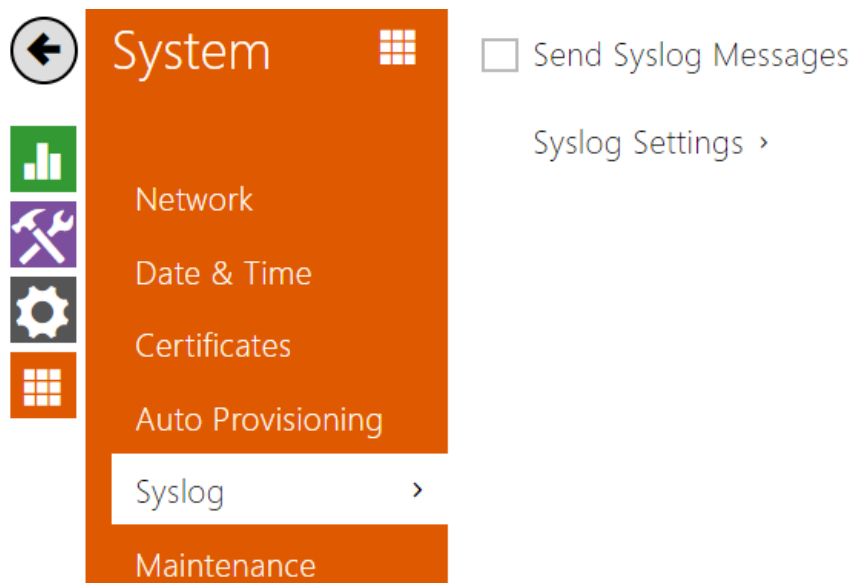

2N[®] Indoor Talk allows you to send syslog messages including relevant device state and process information to a syslog server for recording and further analysis or auditing of the device observed. It is unnecessary to configure this service for common operations.

Parameter List

Send Syslog Messages

- **Send Syslog Messages** - enable sending of syslog messages to the Syslog server. Make sure that the server address is valid.

Syslog Settings ▾

Server Address

Severity Level

- **Server Address** - IP/MAC address of the server on which the syslog recording application is running.
- **Severity Level** - set the detail level of the messages to be sent.

3.2.4.6 Maintenance

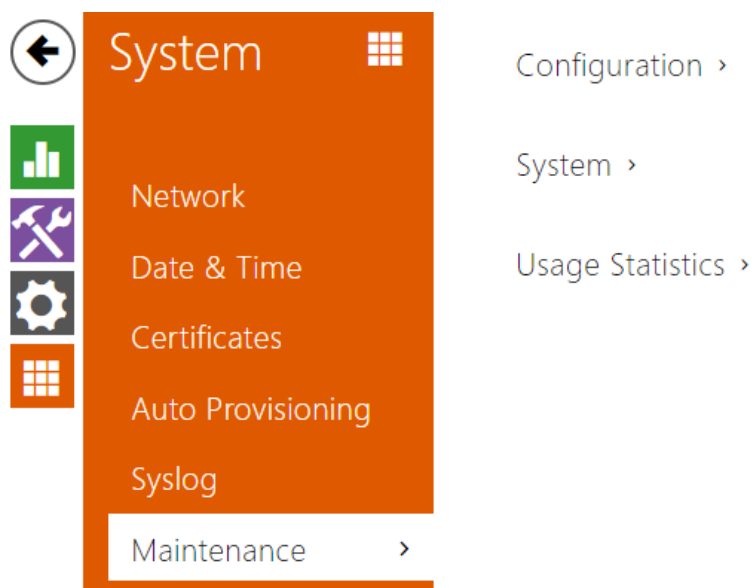

This menu helps you maintain the device configuration and firmware. You can back up and restore all the parameters, upgrade firmware and/or factory reset the device.

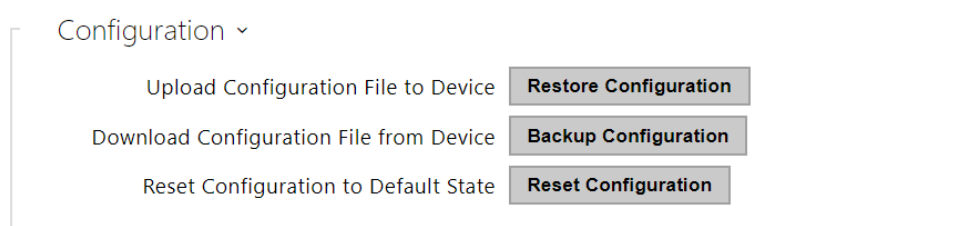

- **Restore Configuration** – restore configuration from a previous backup. Press the button to display a dialogue window to select a configuration file and upload it to the device. Before uploading choose whether or not the LAN settings and SIP PBX connection settings are to be applied.
- **Backup Configuration** – back up the complete current device configuration. Press the button to download all the configuration and stored it on your PC.

Caution

- *As the configuration may include delicate information, such as user phone numbers and access passwords, handle the file cautiously.*

- **Reset Configuration** – reset all the device parameters except for the LAN parameters. To reset the device completely, use the jumper or press Reset.

System ▾

Firmware Version **2.23.0.32.4**

Bootloader Version **1.0.0.0.0**

Software Build Type **Release**

Software Build Date and Time **3/15/2018 14:05:22 PM**

Upgrade Device Firmware **Upgrade Firmware**

Firmware Status **Firmware up to date**

Check Now

Notify of Beta Versions

Restart Device **Restart Device**

Licences **Show**

- **Upgrade Device Firmware** - upload a new firmware version to the device. Press the button to display a dialogue window to select the proper firmware file. Once the firmware is uploaded, the device will be restarted automatically and fully operational with a new firmware version. The firmware upgrading process takes a little less than a minute. Download the current firmware version for your device from www.2n.cz. Firmware upgrade does not affect configuration. The device checks the firmware file and prevents you from uploading an incorrect or corrupt file.
- **Check Now** - check online if a later firmware version is available. If so, the downloading option is offered followed by automatic upgrade.
- **Notify of Beta Versions** - enable monitoring and downloading of the latest firmware beta version.
- **Restart Device** - restart the device. The process takes about 30 s. Once restart is completed and the device is assigned its IP address, the login window will be displayed automatically.
- **Licences** - click Show to open a dialogue window including a list of used licences, third-party software and an EULA link.

Usage Statistics ▾



Send anonymous statistics data







- **Send anonymous statistic data** - enable sending of anonymous statistic data on the device use to the manufacturer. No such delicate information as passwords, access codes or phone numbers are included. This information helps 2N TELEKOMUNIKACE a.s. improve the software quality, reliability and performance. You can participate in this voluntarily and cancel your statistic data deliveries any time.





4. Operational Statuses

This section describes the user scenarios and operational state signalling including user options and expected results of actions.

At Relax



<p>At relax</p>	<p>Call to position 1 destination</p>	<p>press  shortly for 100 ms - 0.5 s</p>	<p>The call start is signalled by a change of the call answering button colour. When the called user answers the call, the device transits into the At call state. If the call is answered within a timeout, the device returns to the Relax mode. The call/lock/hang-up buttons are illuminated blue /yellow/red respectively. The muting and DND buttons are available, the others are inactive.</p>
	<p>Call to position 2 destination</p>	<p>press  for 1.5 s and more</p>	<p>The call start is signalled by a change of the call answering button colour. When the called user answers the call, the device transits into the At call state. If the call is answered within a timeout, the device returns to the Relax mode. The call/lock/hang-up buttons are illuminated blue /yellow/red respectively. The muting and DND buttons are available, the others are inactive.</p>







	Door unlocking	press 	Door unlocking is signalled by a green flash of the lock button and a tone. The other buttons do not change their states. The active call is terminated in 10 s if set so.
	Ringtone selection	press   simultaneously for 3 seconds	The device gets in the ringtone selecting mode.
	Volume up	press 	Each button press increases the ringing volume, which is signalled by a higher button brightness and louder ringtone. When the maximum volume is reached, the button starts flashing. When the 3-second timeout elapses, the ringing volume is set to the last value selected.
	Volume down	press 	Each button press decreases the ringing volume, which is signalled by a lower button brightness and more silent ringtone. When the minimum volume is reached, the button starts flashing. When the 3-second timeout elapses, the ringing volume is set to the last value selected.
	DND mode activation	press 	Press the button to switch on the DND mode.

	Parental lock activation	<p>press </p> <p></p> <p>simultaneously for 3 seconds</p>	Press the buttons at the same time to activate the parental lock; the yellow lock symbol is illuminated.
	Button brightness setting	<p>press </p> <p></p> <p>simultaneously for 3 seconds</p>	The device gets in the button brightness selecting state.



By default, all the buttons are backlit according to the selected brightness level.



Incoming Call

Incoming call	Call answering	<p>press </p>	The device gets in the Call state. The call answering button is flashing: green if the call is coming in from an IP intercom /2N indoor answering unit and blue if the call is coming in from a third-party device. The lock shines yellow, the call end button is red. The other buttons are illuminated blue according to the set brightness level. The volume and mute buttons are available, DND is inactive.
	Call muting	<p>press </p>	The device goes over to the silent (DND) mode. The call answering button is illuminated blue, the lock is yellow and the call end button is red. The other buttons are illuminated blue according to the set brightness level.



	Call rejection	press 	The call is terminated, the device goes over to the relax mode.
	Door unlocking	press 	Door unlocking is signalled by a green flash of the lock button and a tone. The other buttons do not change their states. The active call is terminated in 10 s if set so.
	Parental lock deactivation	press   simultaneously for 3 seconds	The buttons are activated and available again. The device gets in the Incoming call state.
	Ringling volume up	press 	The volume level is increased. The state is signalled by a beep and louder ringtone. When the maximum volume is reached, the button starts flashing.
	Ringling volume down	press 	The volume level is decreased. The state is signalled by a beep and more silent ringtone. When the minimum volume is reached, the button starts flashing.







At Call

At call	Door unlocking	press 	The door is unlocked. The device goes over to the call state, the lock is flashing green. The call is terminated after a timeout if set so.
	Call end	press 	The call is terminated, the device returns to the relax mode.



Microphone muting	press 	The microphone is muted, the button is flashing yellow. The lock, call end and volume control buttons are active. The microphone muting deactivation is inactive. DND is inactive.
Call volume up	press 	Each press increases the volume level. The state is signalled by a beep. When the maximum volume level is reached, the button starts flashing.
Call volume down	press 	Each press decreases the volume level. The state is signalled by a beep. When the minimum volume level is reached, the button starts flashing.







Outgoing Call



Outgoing call	Call to position 1 destination	press  shortly	The call start is signalled by a change of the call answering button colour. When the called user answers the call, the device transits into the At call state. If the call is answered within a timeout, the device returns to the Relax mode. The call/lock/hang-up buttons are illuminated blue/yellow/red respectively. The muting and DND buttons are available, the others are inactive.
	Call to position 2 destination	press  for a long time	The call start is signalled by a change of the call answering button colour. When the called user answers the call, the device transits into the At call state. If the call is answered within a timeout, the device returns to the Relax mode. The call/lock/hang-up buttons are illuminated blue/yellow/red respectively. The muting and DND buttons are available, the others are inactive.

	Call muting	press 	The device goes over to the silent (DND) mode. The call answering button is flashing blue. The call end button is shining red. The other buttons are backlit according to the set brightness level. The volume control, microphone muting and DND buttons are inactive.
	Door unlocking	press 	Door unlocking is signalled by a green flash of the lock button and a tone. The other buttons do not change their states. The active call is terminated in 10 s if set so.
	Parental lock deactivation	press   simultaneously for 3 seconds	The buttons are activated. The device gets in the Incoming call state.
	Ringing volume up	press 	Each press increases the ringing volume level. The state is signalled by a beep and louder ringtone. When the maximum volume is reached, the button starts flashing.
	Ringing volume down	press 	Each press decreases the ringing volume level. The state is signalled by a beep and more silent ringtone. When the minimum volume is reached, the button starts flashing.



Active DND mode

<p>Active DND mode</p>	<p>Call to position 1 destination</p>	<p>press  shortly</p>	<p>The call start is signalled by a change of the call answering button colour. When the called user answers the call, the device transits into the At call state. If the call is answered within a timeout, the device returns to the Relax mode. The call/lock/hang-up buttons are illuminated blue/yellow/red respectively. The muting and DND buttons are available, the others are inactive.</p>
	<p>Call to position 2 destination</p>	<p>press  for a long time</p>	<p>The call start is signalled by a change of the call answering button colour. When the called user answers the call, the device transits into the At call state. If the call is answered within a timeout, the device returns to the Relax mode. The call/lock/hang-up buttons are illuminated blue/yellow/red respectively. The muting and DND buttons are available, the others are inactive.</p>
	<p>Door unlocking</p>	<p>press </p>	<p>Door unlocking is signalled by a green flash of the lock button and a tone. The other buttons do not change their states. The active call is terminated in 10 s if set so.</p>



	<p>Ringtone selection</p>	<p>press </p> <p></p> <p>simultaneously for 3 seconds</p>	<p>The device gets in the ringtone selecting mode.</p>
	<p>Ringling volume up</p>	<p>press </p>	<p>Each button press increases the ringing volume, which is signalled by a higher button brightness and louder ringtone. When the maximum volume is reached, the button starts flashing. When the 3-second timeout elapses, the ringing volume is set to the last value selected.</p>
	<p>Ringling volume down</p>	<p>press </p>	<p>Each button press decreases the ringing volume, which is signalled by a lower button brightness and more silent ringtone. When the minimum volume is reached, the button starts flashing. When the 3-second timeout elapses, the ringing volume is set to the last value selected.</p>
	<p>DND mode deactivation</p>	<p>press </p>	<p>Press the button to deactivate the DND mode and switch the device into the relax mode.</p>
	<p>Parental lock activation</p>	<p>press </p> <p></p> <p>simultaneously for 3 seconds</p>	<p>Press the buttons at the same time to activate the parental lock and switch the device into the active parental lock state in DND. The yellow lock symbol and yellow doorbell symbol are illuminated.</p>

	Button brightness setting	press   simultaneously for 3 seconds	The device goes over to the button brightness setting state.
	Incoming call		The call answering button is flashing.

Active Parental Lock in DND







Active parental lock in DND	Parental lock deactivation	press   simultaneously for 3 seconds	The buttons are activated. The device gets in the DND mode.
	Incoming call		The call answering button is flashing. The lock and call end buttons are illuminated: yellow and red respectively. All of these buttons are inactive. The doorbell (DND) button is shining yellow. The other buttons are not backlit. Deactivate the parental lock to activate the buttons.

Active Parental Lock







Active parental lock	Parental lock deactivation	press   simultaneously for 3 seconds	The buttons are activated. The device gets in the DND mode.
-----------------------------	-----------------------------------	--	---

		Incoming call	
			The call answering button is flashing. The lock and call end buttons are illuminated: yellow and red respectively. All of these buttons are inactive. The doorbell (DND) button is shining yellow. The other buttons are not backlit. Deactivate the parental lock to activate the buttons.

Ringtone Setting Mode

Ringtone setting mode	Next ringtone selection	press 	Press the button to move to the next ringtone to be played.
	Previous ringtone selection	press 	Press the button to move to the previous ringtone to be played.
	Ringtone confirmation	press   simultaneously for 3 seconds or press 	Press the button(s) to confirm the ringtone setting and set the ringtone. You can also idle for 10 s to confirm your selection and quit the mode.
	Selection cancelling	press 	Press the button to cancel the ringtone selection and quit the mode without saving. If the setting is interrupted by an incoming call, the ringtone set before the changes is restored.

Brightness Setting Mode

Brightness setting mode	Brightness intensity up	press 	Each button press increases the brightness intensity, which is signalled by a beep. When the maximum intensity is reached, the symbol flashes three times.
	Brightness intensity down	press 	Each button press decreases the brightness intensity, which is signalled by a beep. When the minimum intensity is reached, the symbol flashes three times.
	Brightness confirmation	press   simultaneously for 3 seconds or press 	Press the button(s) to confirm the selected brightness level. The buttons start shining with the confirmed brightness intensity and two beeps are used for signalling. You can also idle for 10 s to confirm your selection and quit the mode.
	Selection cancelling	press 	Press the button to cancel the brightness intensity selection and quit the mode without saving. If the setting is interrupted by an incoming call, the brightness intensity set before the changes is restored.

Doorbell Activation

Doorbell activation	Doorbell activation		When the doorbell input is activated, the selected tune will be played. Applies to all the modes. You can change the doorbell ringtone in the Services / User sounds section via the user interface.
---------------------	---------------------	---	--

5. Technical Parameters

Power Supply

- **Type:** 12VDC +/-10% adapter or PoE 802.3af injector Phihong PSA16U-480 (POE)
- **Recommended power supply:** 12 V / 1 A
- **Polarity reversal protection:** yes

User Interface

- **Control:** 7 capacitive buttons with RGB LED backlight
- **Service:** RESET button with long press option for factory reset, 3 status LEDs

Audio

- **Microphone:** integrated
- **Speaker:** 2W integrated
- **Induction loop output:** 600 mV_{RMS}

Interface

- **LAN:** 10/100BaseT, RJ-45; Cat5e or higher

Doorbell Input

- **Input type:** switching contact (button/relay)
- **Contact type:** normally open (NO)
- **Contact parameters:** up to 50 V / 5 mA, DC

Mechanical Parameters

- **Dimensions (w x h x d):** 185 x 128 x 48.2 mm
- **Weight:** 387 g
- **Operating temperature:** 0 to 50 °C
- **Relative humidity:** 10 to 90 % non-condensing
- **Storing temperature:** -20 to 70 °C
- **Recommended altitude:** 0 - 2000 m

6. Supplementary Information

This section provides supplementary information on the 2N[®] Indoor Talk product.

Here is what you can find in this section:

- **6.1 Troubleshooting**
- **6.2 Directives, Laws and Regulations - General Instructions and Cautions**

6.1 Troubleshooting



For the most frequently asked questions refer to faq.2n.cz.

6.2 Directives, Laws and Regulations - General Instructions and Cautions

Europe

2N[®] Indoor Talk conforms to the following directives and regulations:

2014/35/EU on the harmonisation of the laws of the Member States relating to the making available on the market of electrical equipment designed for use within certain voltage limits

2014/30/EU on the harmonisation of the laws of the Member States relating to electromagnetic compatibility

2011/65/EU on the restriction of the use of certain hazardous substances in electrical and electronic equipment

2012/19/EU on waste electrical and electronic equipment

Industry Canada

This Class B digital apparatus complies with Canadian ICES-003. / Cet appareil numérique de la classe B est conforme a la norme NMB-003 du Canada.

FCC

NOTE: This equipment has been tested and found to comply with the limits for a Class B digital device, pursuant to part 15 of the FCC Rules. These limits are designed to provide reasonable protection against harmful interference in a residential installation. This equipment generates, uses and can radiate radio frequency energy and, if not installed and used in accordance with the instructions, may cause harmful interference to radio communications. However, there is no guarantee that interference will not occur in a particular installation. If this equipment does cause harmful interference to radio or television reception, which can be determined by turning the equipment off and on, the user is encouraged to try to correct the interference by one or more of the following measures:

- Reorient or relocate the receiving antenna
- Increase the separation between the equipment and receiver
- Connect the equipment into an outlet on a circuit different from that to which the receiver is connected
- Consult the dealer or an experienced radio/TV technician for help.

Changes or modifications to this unit not expressly approved by the party responsible for compliance could void the user's authority to operate this equipment.

 **Caution**

In order to ensure the full functioning and guaranteed outputs we strongly recommend a verification of the timeliness of version of product or facility already during the installation process. The customer takes into consideration that the product or facility can achieve the guaranteed outputs and be fully operational pursuant to the producer's instructions only by using the most recent version of product or facility, which has been tested for full interoperability and has not been determined by the producer as incompatible with certain versions of other products, only in conformity with the producer's instructions, guidelines, manual or recommendation and only in conjunction with suitable products and facilities of the other producers. The most recent versions are available on the website https://www.2n.cz/cs_CZ/, or specific facilities, depending on their technical capacity, allow updating in the configuration interface. Should the customer use any other version of product or facility than the most recent one, or the version that has been determined by the producer as incompatible with certain versions of other producers' products of facilities, or the product or facility in a way incompatible with the producer's instructions, guidelines, manual or recommendation or in conjunction with unsuitable products or facilities of the other producers, he or she is aware of all potential limitations of functionality of such a product or facility and all relating consequences. Should the customer use any other than the most recent version of the product or facility, or the version that has been determined by the producer as incompatible with certain versions of other producers' products of facilities, or the product or facility in a way incompatible with the producer's instructions, guidelines, manual or recommendation or in conjunction with unsuitable products or facilities of the other producers, he or she agrees that the company 2N TELEKOMUNIKACE a. s. is not liable neither for any limitation of such a product's functionality, nor for any damage, loss or injury relating to such a potential limitation of functionality.

Please read this User Manual carefully before using the product. Follow all instructions and recommendations included herein.

Any use of the product that is in contradiction with the instructions provided herein may result in malfunction, damage or destruction of the product.

The manufacturer shall not be liable and responsible for any damage incurred as a result of a use of the product other than that included herein, namely undue application and disobedience of the recommendations and warnings in contradiction herewith.

Any use or connection of the product other than those included herein shall be considered undue and the manufacturer shall not be liable for any consequences arisen as a result of such misconduct.

Moreover, the manufacturer shall not be liable for any damage or destruction of the product incurred as a result of misplacement, incompetent installation and/or undue operation and use of the product in contradiction herewith.

The manufacturer assumes no responsibility for any malfunction, damage or destruction of the product caused by incompetent replacement of parts or due to the use of reproduction parts or components.

The manufacturer shall not be liable and responsible for any loss or damage incurred as a result of a natural disaster or any other unfavourable natural condition.

The manufacturer shall not be held liable for any damage of the product arising during the shipping thereof.

The manufacturer shall not make any warrant with regard to data loss or damage.

The manufacturer shall not be liable and responsible for any direct or indirect damage incurred as a result of a use of the product in contradiction herewith or a failure of the product due to a use in contradiction herewith.

All applicable legal regulations concerning the product installation and use as well as provisions of technical standards on electric installations have to be obeyed. The manufacturer shall not be liable and responsible for damage or destruction of the product or damage incurred by the consumer in case the product is used and handled contrary to the said regulations and provisions.

The consumer shall, at its own expense, obtain software protection of the product. The manufacturer shall not be held liable and responsible for any damage incurred as a result of the use of deficient or substandard security software.

The consumer shall, without delay, change the access password for the product after installation. The manufacturer shall not be held liable or responsible for any damage incurred by the consumer in connection with the use of the original password.

The manufacturer also assumes no responsibility for additional costs incurred by the consumer as a result of making calls using a line with an increased tariff.

Electric Waste and Used Battery Pack Handling



Do not place used electric devices and battery packs into municipal waste containers. An undue disposal thereof might impair the environment!

Deliver your expired electric appliances and battery packs removed from them to dedicated dumpsites or containers or give them back to the dealer or manufacturer for environmental-friendly disposal. The dealer or manufacturer shall take the product back free of charge and without requiring another purchase. Make sure that the devices to be disposed of are complete.

Do not throw battery packs into fire. Battery packs may not be taken into parts or short-circuited either.



An Axis company

2N TELEKOMUNIKACE a.s.

Modřanská 621, 143 01 Prague 4, Czech Republic

Phone: +420 261 301 500, Fax: +420 261 301 599

E-mail: sales@2n.cz

Web: www.2n.cz

v2.25