

4G Mobile Positioning Speed Dome

Quick Start Guide





V1.0.1

General

This Quick Start Guide introduces the structure, installation and basic operations of the 4G Mobile Positioning Speed Dome.

Safety Instructions

The following categorized signal words with defined meaning might appear in the document.

Signal Words	Meaning
 WARNING	Indicates a medium or low potential hazard which, if not avoided, could result in slight or moderate injury.
 CAUTION	Indicates a potential risk which, if not avoided, could result in property damage, data loss, lower performance, or unpredictable result.
 ELECTRICITY	Indicates dangerous high voltage. Take care to avoid coming into contact with electricity.
 ESD	Electrostatic Sensitive Devices. Indicates a device that is sensitive to electrostatic discharge.
 NOTE	Provides additional information as the emphasis and supplement to the text.

Privacy Protection Notice

As the device user or data controller, you might collect personal data of others' such as face, fingerprints, car plate number, Email address, phone number, GPS and so on. You need to be in compliance with the local privacy protection laws and regulations to protect the legitimate rights and interests of other people by implementing measures include but not limited to: providing clear and visible identification to inform data subject the existence of surveillance area and providing related contact.

About the Guide

- The Guide is for reference only. If there is inconsistency between the Guide and the actual product, the actual product shall govern.
- We are not liable for any loss caused by the operations that do not comply with the Guide.
- All the designs and software are subject to change without prior written notice. The product updates might cause some differences between the actual product and the Guide. Please

contact the customer service for the latest program and supplementary documentation.

- There still might be deviation in technical data, functions and operations description, or errors in print. If there is any doubt or dispute, please refer to our final explanation.
- Upgrade the reader software or try other mainstream reader software if the Guide (in PDF format) cannot be opened.
- All trademarks, registered trademarks and the company names in the Guide are the properties of their respective owners.
- Please visit our website, contact the supplier or customer service if there is any problem occurred when using the device.
- If there is any uncertainty or controversy, please refer to our final explanation.

Important Safeguards and Warnings

The following description is the correct application method of the device. Read the Guide carefully before use to prevent danger and property loss. Strictly conform to the Guide during application and keep it properly after reading.

Operating Requirement

- Don't place and install the device in an area exposed to direct sunlight or near heat generating device.
- Keep its horizontal installation, or install it at stable places, and prevent it from falling.
- Use the device only within rated input and output range.
- Don't dismantle the device arbitrarily.
- Transport, use and store the device within allowed humidity and temperature range.
- A magnet is mounted on the base of the device to absorb the installation. If you need to install the device on top of the car, use a specified fixture to install it and avoid device falling down. For detailed operations to fix device with the specified fixture, contact technical support.
- Due to the battery characteristics, when the device is not used for a long time, charge the device regularly (for example, every three months) to prevent it from being abnormal.

Power Requirement

- Make sure to use batteries according to requirements; otherwise, it may result in fire, explosion or burning risks of batteries!
- To replace batteries, only the same type of batteries can be used.
- The product shall use electric wires (power wires) recommended by this area, which shall be used within its rated specification!
- Make sure to use standard power adapter matched with this device. Otherwise, the user shall undertake resulting personnel injuries or device damages.
- Use power supply that meets SELV (safety extra low voltage) requirements, and supply power with rated voltage that conforms to Limited Power Source in IEC60950-1. For specific power supply requirements, see device labels.

Operation and maintenance

- Outdoor use should meet the lightning protection specification.
- Clean the device body with soft dry cloth. If the dirt is difficult to remove, please take a small amount of neutral detergent with a clean soft cloth and wipe gently, then dry the body. Do not use volatile solvent such as alcohol, benzene and thinner, or with strong abrasive cleaner, otherwise it will damage the surface coating or reduce device performance.
- The dome cover is optical device. Please do not directly touch and wipe the cover in installation and application. When infected with dirt such as grease or fingerprints, you can

use absorbent cotton with a little diethyl ether or soft cloth with water to wipe gently. If infected with dirt, also can use air gun to wipe gently.



WARNING

Strengthen network, device data and personnel information protection and take necessary measures to isolate and protect the network security. The measures include but not limited to using password of high strength, changing the device password periodically, upgrading the firmware to the latest version, isolating the computer network, etc.

Table of Contents

Foreword	I
Important Safeguards and Warnings	III
1 Introduction	1
2 Hardware Installation	2
2.1 Checking the Components	2
2.2 Device Structure.....	2
2.2.1 Structural Components.....	2
2.2.2 Device Cable.....	4
2.3 Installing the Device	5
2.3.1 Installing TF Card/SIM Card.....	5
2.3.2 Installing Device on Tripod.....	6
2.4 Battery Operations.....	9
2.4.1 Charging the Battery.....	9
2.4.2 Removing the Battery.....	9
3 Startup and Shutdown	11
3.1 Startup	11
3.2 Shutdown	11
4 Basic Configuration	12
4.1 Initializing the Device.....	12
4.2 Logging in Web	13
4.3 Changing IP Address.....	14
4.4 Network Settings.....	15
4.4.1 3G/4G Network Settings	15
4.4.1.1 Enabling 3G/4G Network.....	15
4.4.1.2 3G/4G Parameter Settings.....	15
4.4.2 Wi-Fi Network Settings.....	17
4.4.3 Wi-Fi Hotspot Settings.....	18
4.5 Automatic Registering to Platform	19
5 FAQ	21
Appendix 1 Optional Accessories	22

1 Introduction

4G Mobile Positioning Speed Dome is a kind of product which can provide video preview, video replay, face detection & query, license plate recognition, Bluetooth, wireless hotspots, video detection and alarm subscription based on the different needs of emergency positioning and mobile monitoring from different industries.

The product is composed of HD camera, array infrared lighting group, high precision PTZ and magnetic sucker, etc. Its features are listed as below:

- Standard push-pull portable box, which makes it easy to carry.
- Tripod option is available to make it convenient for installation and fixing.
- The device is designed with all-aluminum body, strong weather resistance and easy to handle any harsh environment.
- Equipped with HD integrated starlight core, it can achieve 30 times optical zoom lens and support 16 times digital zoom.
- The array infrared lighting group ensures that objects within 100 meters can be clearly photographed in a fully black environment.
- Starlight sensor allows the product to have an excellent video image experience at night.
- It has two modes: Low power consumption and full power high torque, which guarantees the long standby time in ordinary usage scenarios, and avoids the shift of device under certain vibration conditions.
- Can use pad and mobile phone to watch video, operate the device and query video playback by connecting to Wi-Fi directly.

This product can be widely used in public security, energy, government & enterprise, traffic, intelligent building and other areas of the emergency mobile video surveillance.

2 Hardware Installation

2.1 Checking the Components

After open the draw-bar box, check the device appearance without obvious damage and confirm the goods in line with the list of packing. For the list, see Table 2-1.

Name	Number	Name	Number
4G Mobile Positioning Speed Dome	1	Quick Start Guide	1
Power adapter	1	Mounting tray	1
Power cable (1m)	1		

Table 2-1

2.2 Device Structure

2.2.1 Structural Components

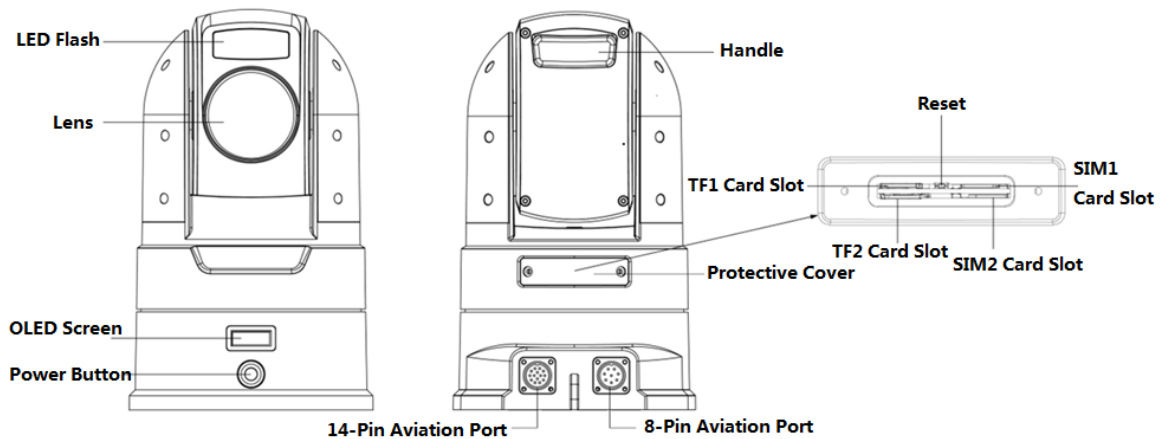









Figure 2-1

Component Name	Function Description
LED Flash	It is used to fill light when the device works in low illumination environment.
Lens	Shoot video images.

Component Name	Function Description
OLED Screen	Display device information in cycle by groups, including IP address and time, 3G/4G connection status, Wi-Fi hotspot connection status, Bluetooth and satellite positioning, battery state, TF card and video status. Please refer to Table 2-3 for the meaning of each icon.
Power Button	<ul style="list-style-type: none"> Press the power button in the shutdown mode to turn on the device. After the device is started, the power indicator light glows blue. Hold down the power button in the started mode to shut down the device. When the device is shutdown, press the power button while holding down the reset button to restore factory defaults.
Handle	Used to carry the device.
Protective Cover	<p>Open the protective cover and can see the TF1/TF2 card slots, SIM1/SIM2 card slots and the reset button.</p> <ul style="list-style-type: none"> TF1/TF2 card slots: Install Micro SD card to save device data. When installing to TF1 slot, insert the TF card with the metal pin face down. When installing to TF 2 slot, insert the TF card with the metal pin face up. SIM1/SIM2 card slots: Install Micro SIM card to connect the device to the network. When installing to SIM1 slot, insert the SIM card with the metal pin face down. When installing to SIM2 slot, insert the SIM card with the metal pin face up. Reset button: In the shutdown mode, hold down the reset button and press the power button at the same time. Release the power button, wait for 6 seconds and the system restores factory defaults.
8-Pin Aviation Port	Connect to 8-pin aviation cable. Please refer to "2.2.2 Device Cable" for detailed introduction.
14-Pin Aviation Port	Connect to 14-pin aviation cable. Please refer to "2.2.2 Device Cable" for detailed introduction.

Table 2-2

Device Info.	Note
3G/4G Connection Status	<p>Display the 3G/4G signal connection status and signal strength of SIM 1 and SIM 2. The more the number, the stronger the signal.</p> <ul style="list-style-type: none"> : SIM 1 no signal. : SIM 1 is connected and its signal strength. : SIM 2 no signal. : SIM 2 is connected and its signal strength.
Wi-Fi Hotspot Connection Status	<p>Display the connection status of hotspot.</p> <ul style="list-style-type: none"> : The hotspot is closed. : The hotspot is enabled but no pad and so on is connected. : The hotspot is enabled and pad and so on is connected.















Device Info.	Note
Bluetooth Status	<p>Display the Bluetooth connection status.</p> <ul style="list-style-type: none">  : The Bluetooth is closed.  : The Bluetooth is enabled but no pairing.  : The Bluetooth is enabled and already paired with the Bluetooth headset.
Satellite Positioning Status	<p>Display the satellite positioning status and signal strength. The more the number, the stronger the signal.</p> <ul style="list-style-type: none">  : Satellite positioning is failed.  : Satellite positioning is successful and its signal strength.
Battery Power	<p>Display the battery power and charging status. The number on the battery represents the percentage of the current electricity.</p> <ul style="list-style-type: none">  : The device is power on and charging.  25% : The device is power off and charging.  : The battery is full in discharge state.
TF Card Status	<p>Display the status for TF1 and TF2.</p> <ul style="list-style-type: none">  : TF1 is not inserted.  : TF1 is inserted.  : TF2 is not inserted.  : TF2 is inserted.
Recording Status	<p>Display the recording status.</p> <ul style="list-style-type: none">  : In recording.  : Recording is not started or already ended.

Table 2-3

2.2.2 Device Cable

NOTE

8-pin aviation cable is not the standard accessory. Please buy it separately.

8-Pin Aviation Cable

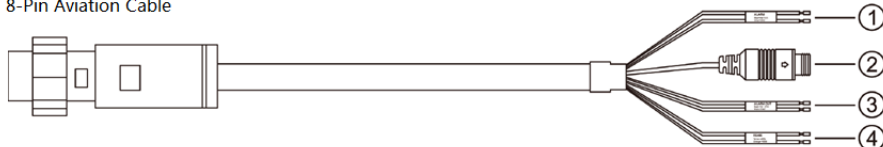

14-Pin Aviation Cable

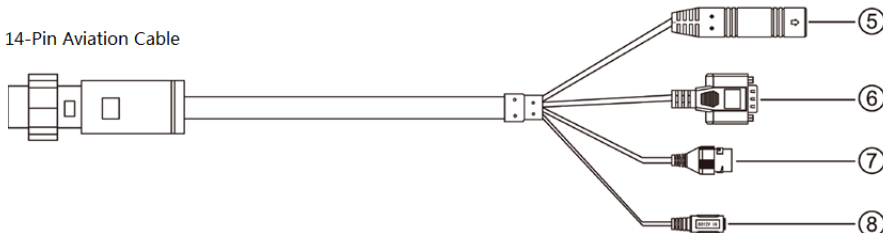

Figure 2-2

No.	Cable Name	Function Description
1	Alarm Input Cable	Connect the alarm device to receive the signal of switching value from external alarm sources. The blue cable is for alarm in and the gray one is GND.
2	Audio Input Port	Connect Audio device for audio input. Meanwhile, it supports the output of DC12V for the power supply of audio device.
3	12V Controllable Power (Alarm) Output	Connect alarm or audio device. Output controllable DC 12V (12V-14V) 0.5A power to be used for alarm output or device power supply. The red cable is +12V CTR and the black one is GND.
4	RS485 Cable	Connect PTZ to control external PTZ and so on. The yellow cable is RS485A and the orange one is RS485B.
5	GPS Port	Connect external GMouse to receive satellite positioning signals.
6	RS232 Port	Connect PC to debug the device.
7	Network Port	Connect standard Ethernet cable to access the device to the network.
8	Power Input Port	Input DC 24V. Please be sure to power the device according to the label instruction.  CAUTION Power supply not according to the label instruction will lead to device damage.

Table 2-4

2.3 Installing the Device

2.3.1 Installing TF Card/SIM Card

Step1 Remove the device protective cover with a screwdriver.

You can see the TF1/TF2 slots and SIM1/SIM2 slots.

Step2 Install the TF card/SIM card as needed.

 **NOTE**

If you need to change the TF card/SIM card, press the card and it will pop up automatically.

- Insert the TF card into the corresponding slot according to the direction shown in Figure 2-3, push the card into the slot, and then press to fix it.



Figure 2-3

- Insert the SIM card into the corresponding slot according to the direction shown in Figure 2-4, push the card into the slot, and then press to fix it.
If only one SIM card is installed, it is recommended to use the SIM1 slot.



Figure 2-4

Step3 Install the cover and tighten the screws.

2.3.2 Installing Device on Tripod

After assembling the tripod, the device can be installed on the tripod to facilitate user operation and shooting.

 **NOTE**

The tripod is not the standard accessory. Please buy it separately.

Step1 Assembling the tripod.

- 1) Take out the tripod, press the foot tube button and flip the tube about 150° in the direction shown in the arrow of Figure 2-5.

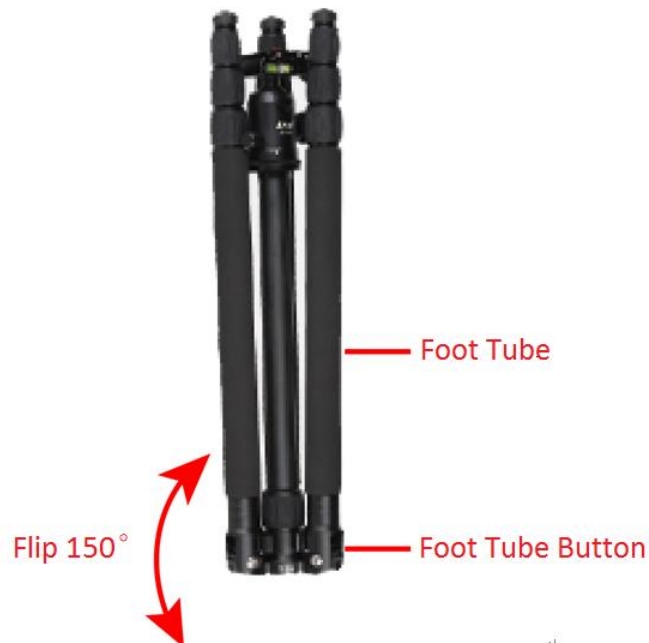

Figure 2-5

- 2) Repeat 1). Flip the rest two foot tubes and push the tube to the appropriate angle according to the shooting environment.
- 3) Adjust the tripod to the appropriate height by adjusting the knob.
The expanded tripod is shown in Figure 2-6. Detailed introductions please refer to Table 2-5



Figure 2-6

Name	Introduction
External Level	For placing the external camera. The angle of the level can be adjusted by adjusting the rotating button next to the external level.
Fastening Button	To lock the external level.
Lock Button	Lock the PTZ to prevent it from rotating.
Axis Lock Button	Freely adjust the PTZ to the required height for shooting.
Foot Tube Button	Press the button to adjust the external angle of the foot tube flexibly to adapt to different shooting environment.
Tube Adjusting Knob	To adjust the length of the foot tube.

Table 2-5

Step2 Install the device.

- 1) Rotate the fastening button and remove the external level of the tripod. The mounting tray of the device can be installed on the PTZ only after removing the external level.
- 2) Install the tray on the PTZ and adjust to the appropriate position, then rotate the fastening button to fix the tray.



Figure 2-7

- 3) The device is placed on the mounting tray and attached to the tray by magnetic force.



Figure 2-8

2.4 Battery Operations

Please refer to this section when you need to charge the battery or remove the battery.

2.4.1 Charging the Battery



Due to the physical properties of the battery, when the environment temperature is above or below the specified temperature, the device may appear to be slow to charge, unable to charge or abnormal discharge.

When the battery is full, it can support device normal work for up to 9 hours continuously. When the battery is insufficient, connect the device to the power supply with the power adapter and the battery can be recharged through the device. The charging status can be seen on the OLED screen.



- You can also take out the battery and charge it through the recharge stand. Please refer to the user's manual of the recharge stand for details. Detailed operation to remove the battery, please see "2.4.2 Removing the Battery."
- The recharge stand is not the standard accessory. Please buy it separately.

2.4.2 Removing the Battery

Step1 Remove the battery

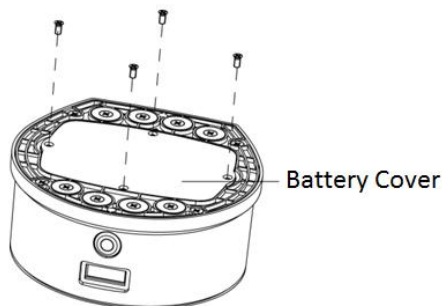

- ① Remove the screws from the device base with the screwdriver and remove the battery cover.

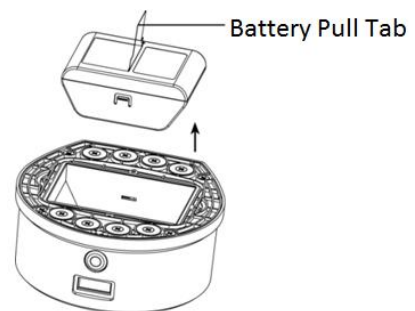

- ② Remove the battery with a quick pull-up of the battery pull tab.

Step2 Install the battery.



When installing the battery, make sure the screws are tightened, otherwise it will affect the battery contact and waterproof reliability of the device.

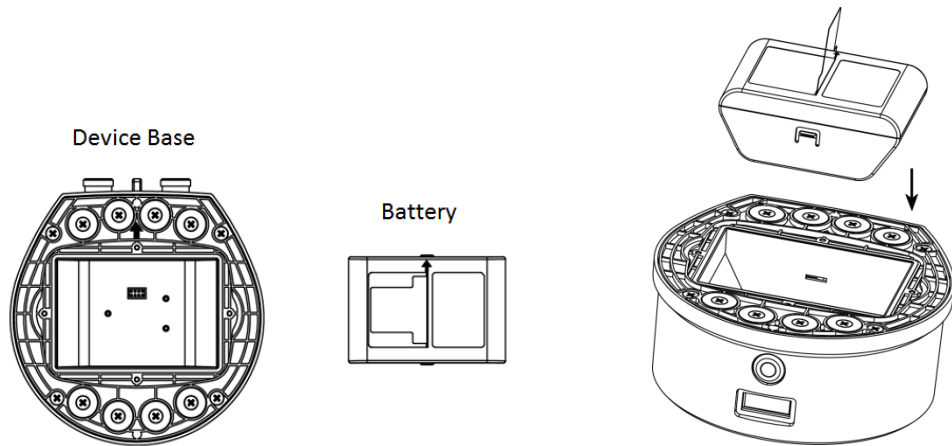

- ① Align the arrow on the battery to the arrow on the device base.
- ② Put down the battery by carrying the pull tab until the battery is stuck.

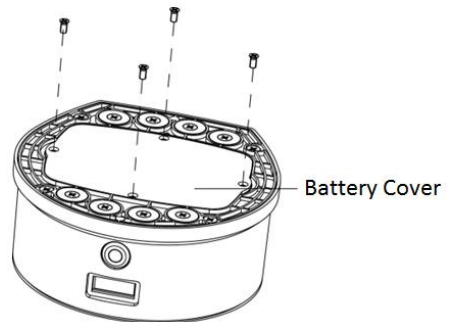
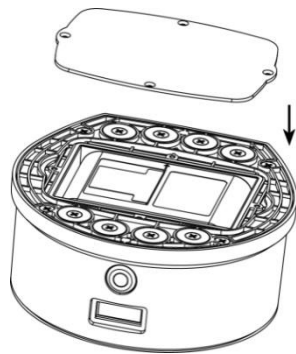

- ③ Align the battery cover to the mounting holes on the device base and install it.
- ④ Install the screws back into the mounting holes and tighten them.

3 Startup and Shutdown

3.1 Startup

When the power supply is connected or the battery is sufficient, short press the power button and the OLED screen shows “Starting...” As shown in Figure 3-1.

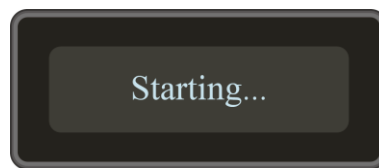

Figure 3-1

3.2 Shutdown

When the device is switched on, long press the device power button and the OLED screen displays “Shutdown now!” As shown in Figure 3-2.

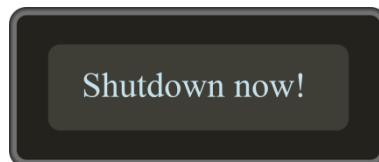

Figure 3-2

4 Basic Configuration

4.1 Initializing the Device

When log in the device for the first time or the device is restored to factory defaults, it needs to be initialized. The device can be configured and operated only after the initialization.

This paper introduces the method of initialization through the “Quick Configuration Tool”. You can also initialize the device in the network parameter item of the Web interface. Details please refer to the user’s manual.

Precondition

- Have connected the PC and the device to the same network through network lines.
- The Quick Configuration Tool has been installed on PC. If you do not get the installation package for Quick Configuration Tool, please contact the personnel for after sales service.

Step1 Open the Quick Configuration Tool, click  and enter the interface to change IP address. Select “Uninitialized Device”.

Step2 Click 

The system displays the interface of “Device Initialization”.

Step3 Select the device needed to be initialized and click “Initialize”.

The system displays the interface of “Device Initialization”. See Figure 4-1.

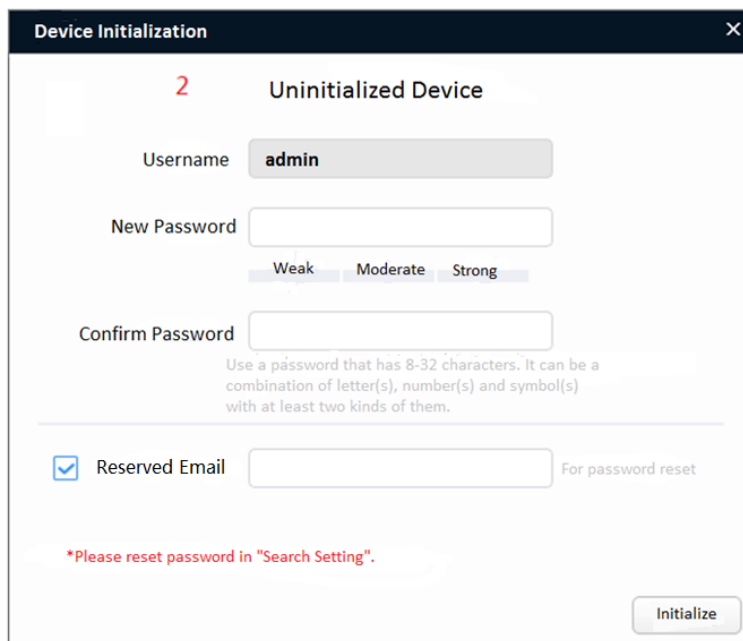

Device Initialization

2 Uninitialized Device

Username

New Password

Weak Moderate Strong

Confirm Password

Use a password that has 8-32 characters. It can be a combination of letter(s), number(s) and symbol(s) with at least two kinds of them.

Reserved Email For password reset

*Please reset password in "Search Setting".

Initialize

Figure 4-1

- Step4** Set the new password and confirm it. Select the “Reserved Email” check box and enter the email address.
- Step5** Click “Initialize” and then the system starts device initialization.
After the initialization, if it's successful, the system displays ✓. If it fails, the system displays ⚠. Click the icon for details.
- Step6** Click “OK”. Device initialization is completed.

4.2 Logging in Web

- Step1** Open the IE browser, enter the device's IP address in the address bar and press Enter. The system pops up a login box, shown as Figure 4-2.

 **NOTE**

- When the Web interface is first logged in, the IP address of the device is 192.168.1.108. When the IP address has been changed according to the network plan, the IP address of the device is the changed one. Detailed operation for IP address change, please refer to "4.3 Changing IP Address."
- The IP address of the device is 192.168.2.108 when the Pad is connected to the network via the device's shared hotspot.



Figure 4-2

- Step2** Enter the username and the password set in initialization.
- Step3** Click “Login”.
The system displays the Web main interface. See Figure 4-3.

 **NOTE**

When you log in for the first time, please install the control according to the system prompts.

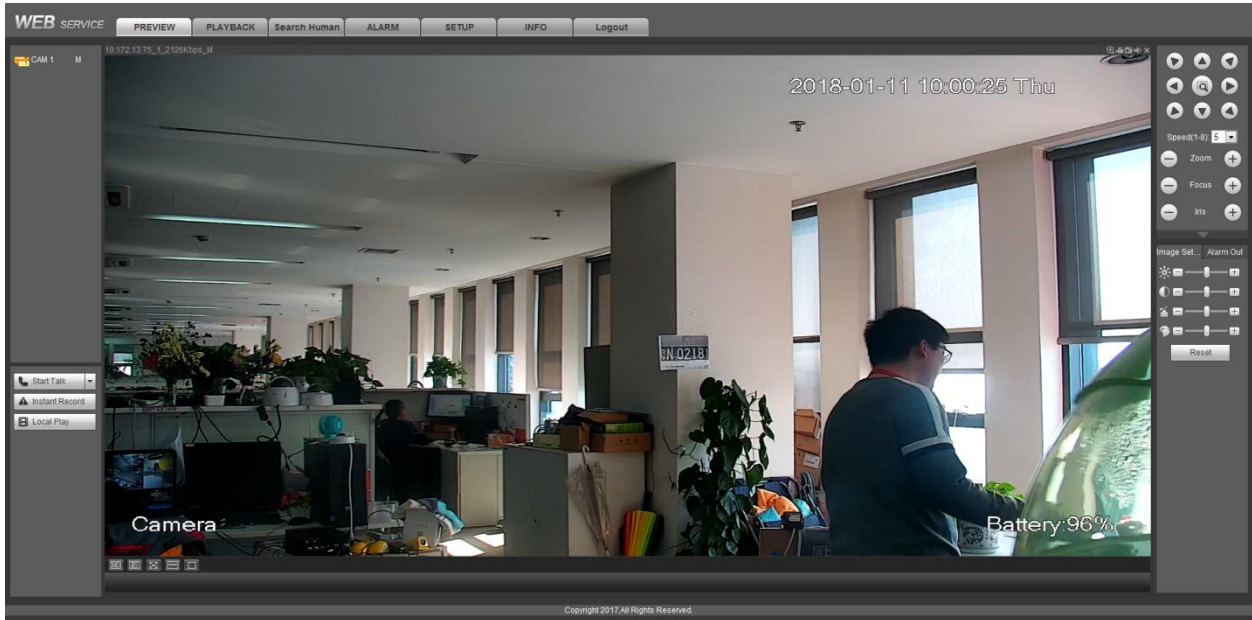

Figure 4-3

4.3 Changing IP Address

Step1 Select “Setup > Network > TCP/IP”.

The system displays “ICP/IP”. See Figure 4-4.

Figure 4-4

Step2 Set the mode to “Static” and input the planned IP address, subnet mask and default gateway.

 **NOTE**

When the DHCP server exists in the network, set the “mode” to “DHCP” and the IP

address can be obtained automatically from the DHCP server.

Step3 Click “Save”.

After the IP address is changed, the new IP address shall be used to log in Web.

4.4 Network Settings

Connect the device to the network through 3G/4G network or Wi-Fi without wiring, which helps to operate and configure the device conveniently. The device can also be used as a hotspot for other terminals.

4.4.1 3G/4G Network Settings

After the SIM card is installed, the device can be connected to the network by dialing, to enable the platform and mobile terminal to receive alarm information, audio/video, picture, device status, etc.

4.4.1.1 Enabling 3G/4G Network

Only after enabling the network of SIM card, the corresponding SIM card can connect to the network normally. The system has enabled the online function of SIM card 1 by default. Please enable the Internet function of SIM card 2 according to the actual needs.

Step1 Select “Setup > Network > 3G/4G > 3G Power on/off”.

The system displays the interface of “3G Power on/off”. See Figure 4-5.

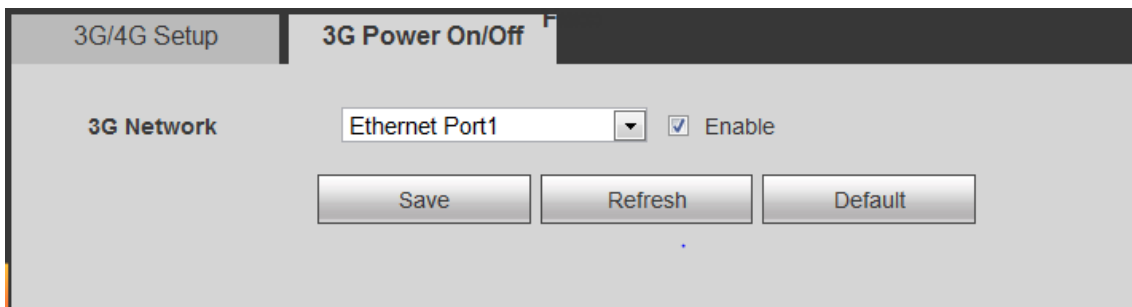

Figure 4-5

Step2 In the “3G Network” box, select the Ethernet port and check “Enable” to enable the Internet function for the SIM card.

Ethernet Port 1 corresponds to SIM card 1, and Ethernet Port 2 corresponds to SIM card 2.

Step3 Click “Save”.

4.4.1.2 3G/4G Parameter Settings

Precondition

- SIM card is installed.
- Have got the dialing number, username and password from the operator.

Step1 Select “Setup > Network > 3G/4G > 3G/4G Setup”.

The system displays the interface of “3G/4G Setup”. See Figure 4-6.

Figure 4-6

Step2 In the “3G Network” box, select the Ethernet port and check “Enable” to enable the network. The Internet function for network card 1 is enabled by default. Network card 1 corresponds to SIM card 1, and Network card 2 corresponds to SIM card 2.

Step3 Set up parameters. Please refer to Table 4-1 for detailed parameter specification.

Parameter	Note
NetAccess	When the device is connected to the private network, select the “NetAccess” check box and select the “APN” and “AUTH”. When the “AUTH” is “PAP” and “CHAP”, the system can access the private network automatically when the username and password are entered.
3G Type	Display network type after enabling, which is to distinguish the different 3G/4G modules from suppliers, like FDD-LTE, etc.
APN	When enabled, display the supplier access point. When select “Customized” for “APN”, APN can be set manually.
Authentication Mode (AUTH)	Including PAP, CHAP and NO_AUTH protocols. The system can identify it automatically after enabling.
Dial No.	Enter the dialing number provided by the operator.
Username	When the “AUTH” is “PAP” and “CHAP”, this parameter needs to be set.
Password	After enabling, the system can identify username and password automatically.
Wireless Signal	Click “Search” to search Wi-Fi signal. After getting the wireless network signal, the signal type and strength can be viewed.

Table 4-1

Step4 Click “Save”.

After the dial-up is successful, module status, SIM status, PPP dial status, working mode, IMSI, IP address, subnet mask, default gateway, module type and ICCID information will be displayed on the “3G Status”.

4.4.2 Wi-Fi Network Settings

Connect the device to the network through Wi-Fi setup.

Step1 Select “Setup > Network > Wi-Fi”.

The system displays Wi-Fi interface.

Step2 Select “Wi-Fi” for the working mode.

The system displays Wi-Fi interface. See Figure 4-7.

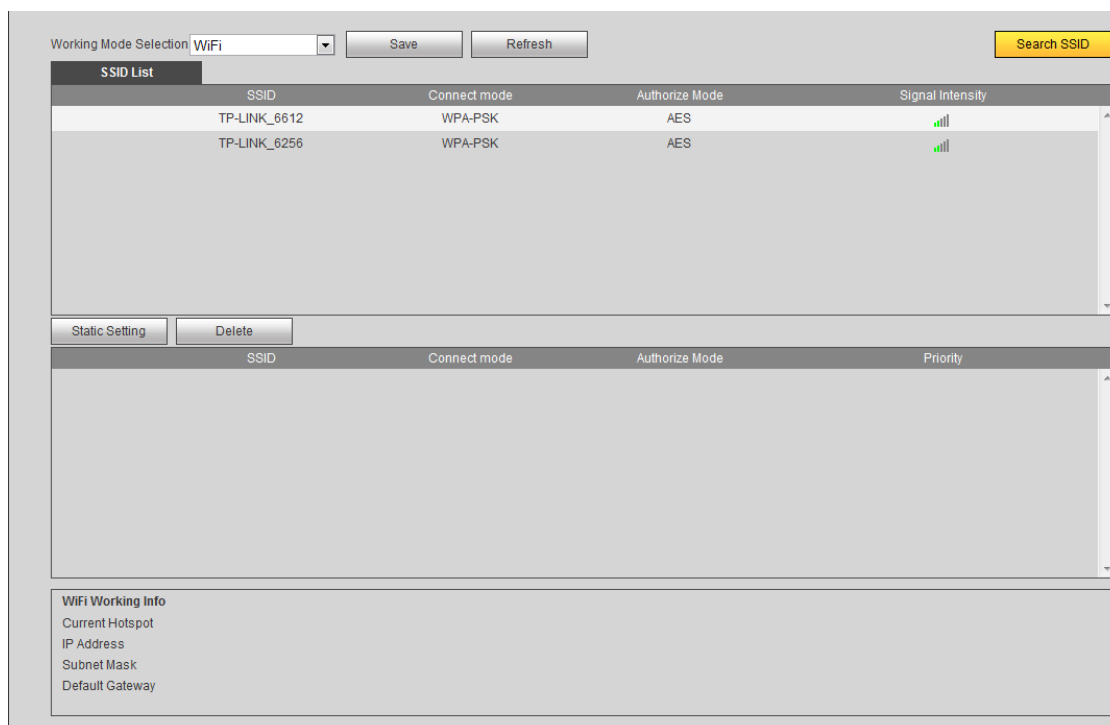

Figure 4-7

Step3 Connect to Wi-Fi.

- Search automatically.
 - 1) Click “Wireless Network SSID Search”.
The name, connection mode, encryption way and signal strength information of all the available wireless networks will be displayed in the “SSID List”.
 - 2) Double click the network needed to be connected, enter password, click “Save” and the net can be connected.
- Add Wi-Fi manually.
 - 1) Click “Static Setting”.
The system displays the “Wi-Fi” interface. See Figure 4-8.

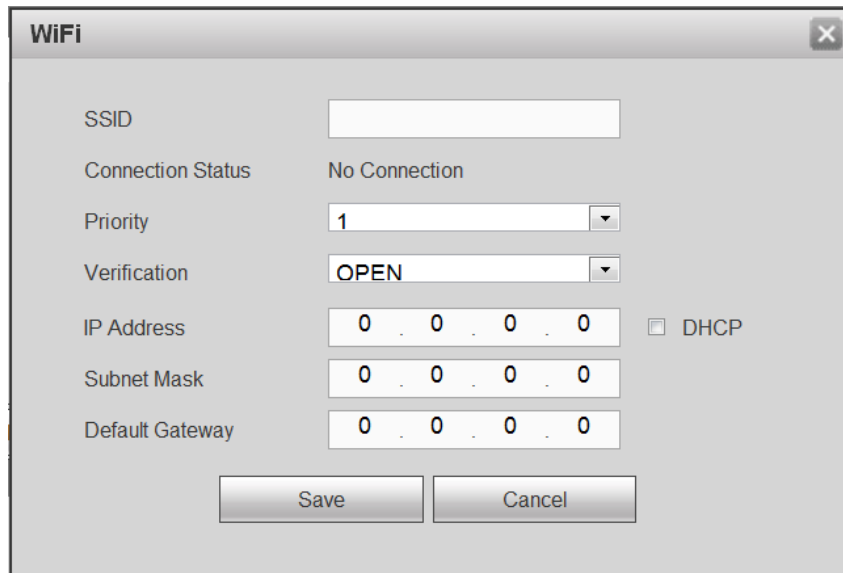

Figure 4-8

- 2) Enter SSID and password, select priority, verification and encryption way, set IP address, subnet mask and default gateway, and click “Save”.
If “DHCP” is enabled, after successful connection, the system will obtain the corresponding IP address for Wi-Fi, subnet mask and default gateway automatically.
- 3) Click “Save”.

Step4 Click “Save”.

Click “Refresh” to obtain the connection status.

After the connection is successful, the current hotspot, IP address, subnet mask and default gateway can be looked at in the “Wi-Fi Working Information”.

4.4.3 Wi-Fi Hotspot Settings

The device can be used as a hotspot for other terminals. The terminals can log in the device via the server IP 192.168.2.108. After login, it can preview video and operate the rotation of the speed dome.

Step1 Select “Setup > Network > Wi-Fi”.

The system displays the “Wi-Fi” interface.

Step2 Select “Ap” as the working mode.

The system displays the hotspot setup interface. See Figure 4-9.

WiFi

Working Mode Selection: Ap [Save] [Refresh]

SSID: 4GDOMEAP_00000

Working Frequency: 5G

Verification: WPA2-PSK

Connection Password: ●●●●●●

Server IP: 192.168.2.108

No.	IP	MAC Address

Figure 4-9

Step3 Enter SSID, select working frequency and verification type, and set the connection password.

- The working frequency includes 2.4G and 5G. 5G is default. Please select according to actual needs.
- The default connection password is 12345678.

Step4 Click “Save”.

4.5 Automatic Registering to Platform

After automatic registration, when the device is connected to the external network, it will actively report the current location to the platform, so that the client software can access the device through the platform for preview and monitoring.

Step1 Select “Setup > Network > Register”.

The system displays the “Register” interface. See Figure 4-10.

REGISTER

Enable

Server IP: 0.0.0.0

Port: 9500 (0-65535)

Sub-device ID: 000000000000000000

[Save] [Refresh] [Default]

Figure 4-10

Step2 Select “Enable” to enable the automatic registration function. This function is enabled by default.

Step3 Set the parameters. Detailed instructions please refer to Table 2-2.

Parameter	Note
Server IP	Enter the server IP address or domain name that you need to register to.
Port	The server port number used for active registration.
Sub-device ID	The ID shall be unique. When different devices are registered to the same server, the sub-device IDs shall not be the same.

Table 4-2

Step4 Click "Save".

Fault Symptom	Possible Cause	Solution
No motion after power on. No image and black device screen.	Abnormal power supply.	<ul style="list-style-type: none"> ● Use 24V adapter to power the device to see whether the OLED screen shows charging. If no charge is displayed, it is the device power failure. If the OLED screen shows charging, the battery is not enough. If the device fails to turn on when the battery is full, the device fails. ● With 24V adapter for power supply, the device can be turned on. If the device fails to turn on when the battery is powered, the battery fails.
Self-check is abnormal. There are images but accompanied by motor calls.	<ul style="list-style-type: none"> ● The device may be blocked by an object when it rotates. ● Mechanical Fault. 	<ol style="list-style-type: none"> 1. Check if the device is placed well. 2. If there is no obstruction in the device place, it is a mechanical failure of the device. Please send it back to the factory for repair.
Mobile phone or Pad cannot search the Wi-Fi hotspot of the device.	<ul style="list-style-type: none"> ● The device Wi-Fi hotspot is not enabled. ● The working frequency of the Wi-Fi hotspot is 5G. 	Enable the Wi-Fi hotspot of the device according to "4.4.3 Wi-Fi Hotspot."
		When the working frequency of the device Wi-Fi is 5G, and the mobile phone or Pad does not support 5G frequency, then the device hotspot cannot be found. Please refer to "4.4.3 Wi-Fi Hotspot" to adjust the working frequency of the device Wi-Fi hotspot to 2.4G.

Appendix 1 Optional Accessories

When using the device, some accessories can be selected. If you want to use the optional accessories, please buy separately. Please refer to Appendix Table 1-1 for the available list.

Accessory	Number	Accessory	Number
8-Pin Aviation Cable	1	External GMouse	1
Sound Pick-up	1	Backup Battery	1
Battery Recharge Stand	1	Tripod	1

Appendix Table 1-1