

4G Mobile Positioning Speed Dome

User's Manual

V1.0.1

Cybersecurity Recommendations

Mandatory actions to be taken towards cybersecurity

1. Change Passwords and Use Strong Passwords:

The number one reason systems get “hacked” is due to having weak or default passwords. It is recommended to change default passwords immediately and choose a strong password whenever possible. A strong password should be made up of at least 8 characters and a combination of special characters, numbers, and upper and lower case letters.

2. Update Firmware

As is standard procedure in the tech-industry, we recommend keeping NVR, DVR, and IP camera firmware up-to-date to ensure the system is current with the latest security patches and fixes.

“Nice to have” recommendations to improve your network security

1. Change Passwords Regularly

Regularly change the credentials to your devices to help ensure that only authorized users are able to access the system.

2. Change Default HTTP and TCP Ports:

- Change default HTTP and TCP ports for systems. These are the two ports used to communicate and to view video feeds remotely.
- These ports can be changed to any set of numbers between 1025-65535. Avoiding the default ports reduces the risk of outsiders being able to guess which ports you are using.

3. Enable HTTPS/SSL:

Set up an SSL Certificate to enable HTTPS. This will encrypt all communication between your devices and recorder.

4. Enable IP Filter:

Enabling your IP filter will prevent everyone, except those with specified IP addresses, from accessing the system.

5. Change ONVIF Password:

On older IP Camera firmware, the ONVIF password does not change when you change the system’s credentials. You will need to either update the camera’s firmware to the latest revision or manually change the ONVIF password.

6. Forward Only Ports You Need:

- Only forward the HTTP and TCP ports that you need to use. Do not forward a huge range of numbers to the device. Do not DMZ the device's IP address.
- You do not need to forward any ports for individual cameras if they are all connected to a recorder on site; just the NVR is needed.

7. Disable Auto-Login on SmartPSS:

Those using SmartPSS to view their system and on a computer that is used by multiple people should disable auto-login. This adds a layer of security to prevent users without the appropriate credentials from accessing the system.

8. Use a Different Username and Password for SmartPSS:

In the event that your social media, bank, email, etc. account is compromised, you would not want

someone collecting those passwords and trying them out on your video surveillance system. Using a different username and password for your security system will make it more difficult for someone to guess their way into your system.

9. Limit Features of Guest Accounts:

If your system is set up for multiple users, ensure that each user only has rights to features and functions they need to use to perform their job.

10. UPnP:

- UPnP will automatically try to forward ports in your router or modem. Normally this would be a good thing. However, if your system automatically forwards the ports and you leave the credentials defaulted, you may end up with unwanted visitors.
- If you manually forwarded the HTTP and TCP ports in your router/modem, this feature should be turned off regardless. Disabling UPnP is recommended when the function is not used in real applications.

11. SNMP:

Disable SNMP if you are not using it. If you are using SNMP, you should do so only temporarily, for tracing and testing purposes only.

12. Multicast:

Multicast is used to share video streams between two recorders. Currently there are no known issues involving Multicast, but if you are not using this feature, deactivation can enhance your network security.

13. Check the Log:

If you suspect that someone has gained unauthorized access to your system, you can check the system log. The system log will show you which IP addresses were used to login to your system and what was accessed.

14. Physically Lock Down the Device:

Ideally, you want to prevent any unauthorized physical access to your system. The best way to achieve this is to install the recorder in a lockbox, locking server rack, or in a room that is behind a lock and key.

15. Connect IP Cameras to the PoE Ports on the Back of an NVR:

Cameras connected to the PoE ports on the back of an NVR are isolated from the outside world and cannot be accessed directly.

16. Isolate NVR and IP Camera Network

The network your NVR and IP camera resides on should not be the same network as your public computer network. This will prevent any visitors or unwanted guests from getting access to the same network the security system needs in order to function properly.

General







This user's manual (hereinafter referred to be "the Manual") introduces the functions and operations of the 4G Mobile Positioning Speed Dome (hereinafter referred to be "the Device").

Models

MSB-L200

Safety Instructions

The following categorized signal words with defined meaning might appear in the Manual.

Signal Words	Meaning
 DANGER	Indicates a high potential hazard which, if not avoided, will result in death or serious injury.
 WARNING	Indicates a medium or low potential hazard which, if not avoided, could result in slight or moderate injury.
 CAUTION	Indicates a potential risk which, if not avoided, could result in property damage, data loss, lower performance, or unpredictable result.
 ELECTRICITY	Indicates dangerous high voltage. Take care to avoid coming into contact with electricity.
 ESD	Electrostatic Sensitive Devices. Indicates a device that is sensitive to electrostatic discharge.
 TIPS	Provides methods to help you solve a problem or save you time.
 NOTE	Provides additional information as the emphasis and supplement to the text.

Revision History

No.	Version	Revision Content	Release Time
1	V1.0.0	First Release	February, 2018
2	V1.0.1	Add privacy protection notice.	May, 2018

Privacy Protection Notice

As the device user or data controller, you might collect personal data of others' such as face, fingerprints, Email address, phone number, GPS and so on. You need to be in compliance with the local privacy protection laws and regulations to protect the legitimate rights and interests of other people by implementing measures include but not limited to: providing clear and visible identification to inform data subject the existence of surveillance area and providing related contact.

About the Manual

- The Manual is for reference only. If there is inconsistency between the Manual and the actual product, the actual product shall govern.
- We are not liable for any loss caused by the operations that do not comply with the Manual.
- The Manual would be updated according to the latest laws and regulations of related regions. For detailed information, see the paper User's Manual, CD-ROM, QR code or our official website. If there is inconsistency between paper User's Manual and the electronic version, the electronic version shall prevail.
- All the designs and software are subject to change without prior written notice. The product updates might cause some differences between the actual product and the Manual. Please contact the customer service for the latest program and supplementary documentation.
- There still might be deviation in technical data, functions and operations description, or errors in print. If there is any doubt or dispute, please refer to our final explanation.
- Upgrade the reader software or try other mainstream reader software if the Manual (in PDF format) cannot be opened.
- All trademarks, registered trademarks and the company names in the Manual are the properties of their respective owners.
- Please visit our website, contact the supplier or customer service if there is any problem occurred when using the device.
- If there is any uncertainty or controversy, please refer to our final explanation.

Important Safeguards and Warnings

The following description is the correct application method of the device. Read the manual carefully before use to prevent danger and property loss. Strictly conform to the manual during application and keep it properly after reading.

Operating Requirement

- Don't place and install the device in an area exposed to direct sunlight or near heat generating device.
- Keep its horizontal installation, or install it at stable places, and prevent it from falling.
- Use the device only within rated input and output range.
- Don't dismantle the device arbitrarily.
- Transport, use and store the device within allowed humidity and temperature range.
- A magnet is mounted on the base of the device to absorb the installation. If you need to install the device on top of the car, use a specified fixture to install it and avoid device falling down. For detailed operations to fix device with the specified fixture, contact technical support.
- Due to the battery characteristics, when the device is not used for a long time, charge the device regularly (for example, every three months) to prevent it from being abnormal.

Power Requirement

- Make sure to use batteries according to requirements; otherwise, it may result in fire, explosion or burning risks of batteries!
- To replace batteries, only the same type of batteries can be used.
- The product shall use electric wires (power wires) recommended by this area, which shall be used within its rated specification!
- Make sure to use standard power adapter matched with this device. Otherwise, the user shall undertake resulting personnel injuries or device damages.
- Use power supply that meets SELV (safety extra low voltage) requirements, and supply power with rated voltage that conforms to Limited Power Source in IEC60950-1. For specific power supply requirements, see device labels.

Operation and maintenance

- Outdoor use should meet the lightning protection specification.
- Clean the device body with soft dry cloth. If the dirt is difficult to remove, please take a small amount of neutral detergent with a clean soft cloth and wipe gently, then dry the body. Do not use volatile solvent such as alcohol, benzene and thinner, or with strong abrasive cleaner, otherwise it will damage the surface coating or reduce device performance.
- The dome cover is optical device. Please do not directly touch and wipe the cover in installation and application. When infected with dirt such as grease or fingerprints, you can use absorbent cotton with a little diethyl ether or soft cloth with water to wipe gently. If

infected with dirt, also can use air gun to wipe gently.



WARNING

Strengthen network, device data and personnel information protection and take necessary measures to isolate and protect the network security. The measures include but not limited to using password of high strength, changing the device password periodically, upgrading the firmware to the latest version, isolating the computer network, etc.

Table of Contents

Cybersecurity Recommendations	II
Foreword	IV
Important Safeguards and Warnings	VI
1 Introduction	1
1.1 Overview	1
1.2 Features	1
2 Installing Hardware	4
2.1 Checking the Components	4
2.2 Device Structure.....	4
2.2.1 Structural Components.....	4
2.2.2 Device Cable.....	6
2.3 Installing the Device	7
2.3.1 Installing TF Card/SIM Card.....	7
2.3.2 Installing Device on Tripod.....	8
2.4 Operating the Battery	11
2.4.1 Charging the Battery.....	11
2.4.2 Removing the Battery.....	11
3 Startup and Shutdown	13
3.1 Startup	13
3.2 Shutdown	13
4 Basic Configuration	14
4.1 Initializing the Device.....	14
4.2 Logging in Web	15
4.3 IP Address Settings	17
4.4 Basic Information Settings.....	18
4.4.1 Native Information Settings	18
4.4.2 System Date Settings.....	19
4.4.3 Screen-out Mode Settings	21
4.4.4 GPS Settings	21
4.5 Record Control Settings.....	22
4.6 Record Plan Settings.....	23
4.7 Snapshot Plan Settings.....	24
5 Business Operations	26
5.1 Preview	26
5.1.1 Real-Time Monitoring Channel	27
5.1.2 Voice Intercom.....	28
5.1.3 PTZ Console	29
5.1.4 Image/Alarm Settings	33
5.2 Playback.....	34
5.2.1 Control Bar	35
5.2.2 Playing back Records.....	35

5.2.3 Clipping Record Files	37
5.2.4 Downloading Record Files.....	37
5.3 Face Image Query	41
5.4 Subscribing Alarm Events.....	42
5.4.1 Understanding Alarm Types	42
5.4.2 Alarm Subscription Settings.....	43
6 System Settings	44
6.1 Network Parameter Settings	44
6.1.1 Connection Parameter Settings.....	44
6.1.2 Wi-Fi Parameter Settings.....	50
6.1.3 3G/4G Network Settings	52
6.1.4 Automatic Registration Settings.....	54
6.1.5 Bluetooth Settings.....	54
6.2 Camera Parameter Settings.....	56
6.2.1 Encoding Parameter Settings	56
6.2.2 Channel Name Settings	60
6.2.3 Viewing Camera Information	60
6.3 Alarm Event Settings	61
6.3.1 Video Detection Settings.....	61
6.3.2 Alarm Settings.....	63
6.3.3 Abnormality Handling Settings	65
6.3.4 Alarm Output Settings.....	66
6.4 Storage Device Management.....	67
6.4.1 Memory Card Management.....	67
6.4.2 Viewing Memory Card Information	67
6.5 System Information Settings	68
6.5.1 Video Mirroring Settings.....	68
6.5.2 User Account Management	68
7 System Maintenance.....	75
7.1 Requirements	75
7.2 Viewing Device Information	75
7.2.1 Viewing Version Information	75
7.2.2 Viewing System Logs	76
7.2.3 Viewing Satellite Information	77
7.2.4 Viewing Battery Power Status	77
7.3 Device Reboot.....	78
7.4 Backup and Recovery	78
7.4.1 Backing Up Configuration	78
7.4.2 Restoring Configuration	78
7.4.3 Restoring System Defaults	79
7.5 System Upgrade	79
8 Logout.....	81
9 DSS Operation.....	82
Appendix 1 Optional Accessories.....	83

Introduce the characteristics and functional features of the products.

1.1 Overview

4G Mobile Positioning Speed Dome is a kind of product which can provide video preview, video replay, face detection & query, license plate recognition, Bluetooth, wireless hotspots, video detection and alarm subscription based on the different needs of emergency positioning and mobile monitoring from different industries.

The product is composed of modules such as HD camera, array infrared light group, high precision PTZ and magnetic sucker. Its features are listed as below:

- Standard draw-bar box, which makes it easy to carry.
- Tripod option is available to make it convenient for installation and fixing.
- The device is designed with all-aluminum body, strong weather resistance and easy to handle any harsh environment.
- Equipped with HD integrated starlight core, it can achieve 30 times optical zoom lens and support 16 times digital zoom.
- The array infrared lighting group ensures that objects within 100 meters can be clearly photographed in a fully black environment.
- Starlight sensor allows the product to have an excellent video image experience at night.
- It has two modes: Low power consumption and full power high torque, which guarantees the long standby time in ordinary usage scenarios, and avoids the shift of device under certain vibration conditions.
- Can use pad and mobile phone to watch video, operate the device and query video playback by connecting to Wi-Fi directly.

This product can be widely used in public security, energy, government & enterprise, traffic, intelligent building and other areas of the emergency mobile video surveillance.

1.2 Features

Real-Time Monitoring

Function	Description
Real-time preview	<ul style="list-style-type: none">• Support video image preview.• Support the flip of video image from top to bottom and left to right.

Function	Description
PTZ control	<ul style="list-style-type: none"> Operate the camera through PTZ to expand the scope of surveillance, or to locate and recognize target details. Such as turning the camera and setting preset point, tour group, pattern and horizontal rotation. Support to set camera parameters through the PTZ menu.
Audio Talk	<ul style="list-style-type: none"> Be able to contact the front-end monitoring site in time for quick handling of abnormalities. Support voice intercom through Bluetooth headsets.
Local snapshot	Snapshot when abnormal event occurs. It is available for subsequent review.
Local record	Record when abnormal event occurs. It is available for subsequent review.
Dual stream	Support the switch of video streams.
Other functions	<ul style="list-style-type: none"> Enable the alarm output port. Enlarge video image partially. Support optical zoom and digital zoom, and can enlarge video images. Adjust the display effect of video images.

Record Playback

Function	Description
Manual record	Taking record of the key images in preview for subsequent viewing and abnormality handling.
Record plan	After setting the record plan, the system records automatically according to the plan.
Record playback and download	<ul style="list-style-type: none"> Play back records to view the valuable record clips. Download valuable record clips to use as the basis of judging things.
Alarm linkage record	Linked to record taking when an alarm occurs.

Face Query

- Search and export the face information in the snapped pictures of face detection.
- Play and download the records with face detected.

Alarm

- Set alarm prompting mode or sound according to alarm type.
- View alarm information.

Network Functions

- Access network through cables, 3G/4G and Wi-Fi.
- Can work as a hotspot for other terminals by default.
- Support GPS positioning.

User Management

Function	Note
User group management	<ul style="list-style-type: none"> • Add, modify and delete new user groups. • Manage user authorities according to user groups.
User management	<ul style="list-style-type: none"> • Add, modify and delete users. • Configure user authorities. • View online users. • Configure the reserved email for admin account.
Modify password	Modify user password.
Reset password	Reset admin password with the reserved email.

Event Management

Function	Description
Record detection	<ul style="list-style-type: none"> • Support motion detect and tampering detection. • When an alarm occurs, it supports actions such as record linkage, alarm output and snapshot.
Alarm settings	<ul style="list-style-type: none"> • Trigger alarm when there is an alarm from the alarm input device. • When an alarm occurs, it supports actions such as record activation, alarm output and snapshot.
Abnormality handling	<ul style="list-style-type: none"> • Support the abnormality detection of memory card, network and the device. • When network abnormality or illegal access alarm occurs, it supports linked alarm output and system logs. • When memory card abnormality alarm occurs, it supports linkage actions of alarm output, system logs and automatic system restart.

Docking Platform

- Automatically register to the platform.

2 Installing Hardware

2.1 Checking the Components

After open the draw-bar box, check the device appearance without obvious damage and confirm the goods in line with the list of packing. For the list, see Table 2-1.

Table 2-1 Accessory list

Name	Number	Name	Number
4G Mobile Positioning Speed Dome	1	Quick Start Guide	1
Power adapter	1	Mounting tray	1
Power cable (1m)	1		

2.2 Device Structure

2.2.1 Structural Components

Figure 2-1 Structural components

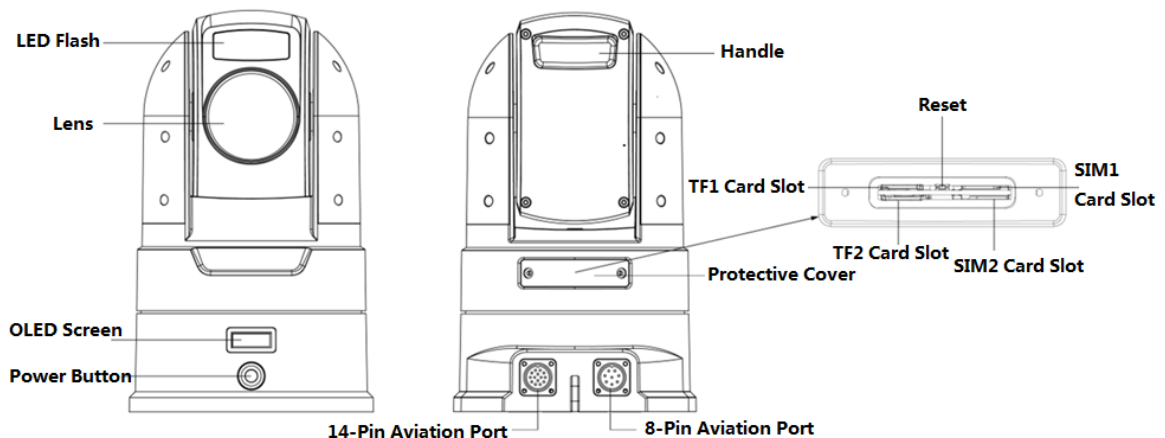

Table 2-2 Description of structural components

Name	Description
LED flash	It is used to fill light when the device works in low illumination environment.
Lens	Shoot video images.

Name	Description
OLED screen	Display device information in cycle by groups, including IP address and time, 3G/4G connection status, Wi-Fi hotspot connection status, Bluetooth and satellite positioning, battery state, TF card and video status. See Table 2-3 for the meaning of each icon.
Power button	<ul style="list-style-type: none"> Press the power button in the shutdown mode to turn on the device. After the device is started, the power indicator light keeps on in blue. Hold down the power button in the turn-on mode to shut down the device. When the device is shutdown, holding down the reset button while pressing the power button can restore factory defaults.
Handle	Used to carry the device.
Protective cover	<p>Open the protective cover and you can see the TF1/TF2 card slots, SIM1/SIM2 card slots and the reset button.</p> <ul style="list-style-type: none"> TF1/TF2 card slots: Install Micro SD card to store device data. When installing to TF1 slot, insert the TF card with the metal pin face down. When installing to TF 2 slot, insert the TF card with the metal pin face up. SIM1/SIM2 card slots: Install Micro SIM card to connect the device to the network. When installing to SIM1 slot, insert the SIM card with the metal pin face down. When installing to SIM2 slot, insert the SIM card with the metal pin face up. Reset button: In the shutdown mode, hold down the reset button and press the power button at the same time. Release the power button, wait for 6 seconds and the system restores factory defaults.
8-pin aviation port	Connect to 8-pin aviation cable. See "2.2.2 Device Cable" for detailed introduction.
14-pin aviation port	Connect to 14-pin aviation cable. See "2.2 Device Cable" for detailed introduction.

Table 2-3 Description of icons on OLED screen

Device Information	Description
3G/4G connection status	<p>Display the 3G/4G signal connection status and signal strength of SIM 1 and SIM 2. The more the number, the stronger the signal.</p> <ul style="list-style-type: none"> SIM 1 no signal. SIM 1 is connected and its signal strength. SIM 2 no signal. SIM 2 is connected and its signal strength.
Wi-Fi hotspot connection status	<p>Display the connection status of hotspot.</p> <ul style="list-style-type: none"> The hotspot is closed. The hotspot is enabled but no pad is connected. The hotspot is enabled and pad is connected.
Bluetooth status	<p>Display the Bluetooth connection status.</p> <ul style="list-style-type: none"> The Bluetooth is closed. The Bluetooth is enabled but no pairing. The Bluetooth is enabled and already paired with the Bluetooth headsets.

Device Information	Description
Satellite positioning status	<p>Display the satellite positioning status and signal strength. The more the number, the stronger the signal.</p> <p> Satellite positioning is failed. Satellite positioning is successful and its signal strength.</p>
Battery power	<p>Display the battery power and charging status. The number on the battery represents the percentage of the current electricity.</p> <ul style="list-style-type: none"> The device is power on and charging. The device is power off and charging. The battery is full in discharge state.
TF card status	<p>Display the status of TF1 and TF2.</p> <ul style="list-style-type: none"> TF1 is not inserted. TF1 is inserted. TF2 is not inserted. TF2 is inserted.
Recording status	<p>Display the recording status.</p> <p> In recording. Recording is not started or already ended.</p>

2.2.2 Device Cable

NOTE

8-pin aviation cable is not the standard accessory. You need to buy it separately.

Figure 2-2 Device cable

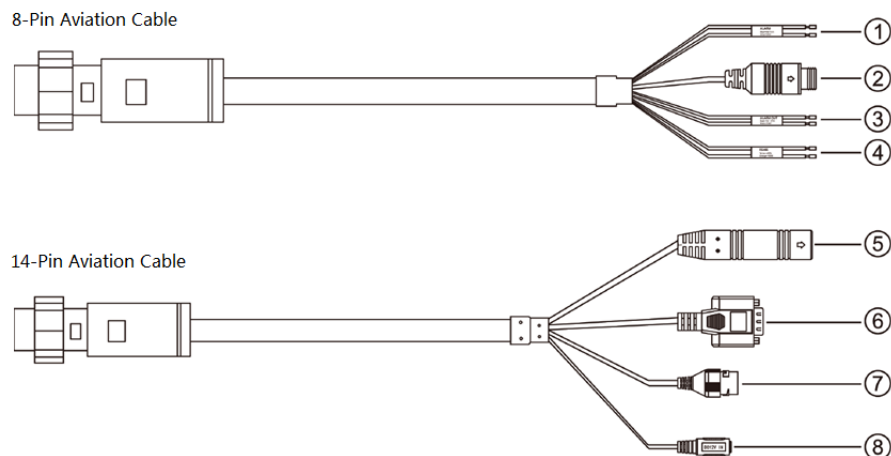



Table 2-4 Description of cable functions

No	Cable Name	Description
1	Alarm input cable	<p>Connect the alarm device to receive the signal of switching value from external alarm sources.</p> <p>The blue cable is for alarm in and the gray one is GND.</p>
2	Audio input port	Connect Audio device for audio input. Meanwhile, it supports the output of

No	Cable Name	Description
		DC12V for the power supply of audio device.
3	12V controllable power (alarm) output	Connect alarm or audio device. Output controllable DC 12V (12V-14V) 0.5A power to be used for alarm output or device power supply. The red cable is +12V CTR and the black one is GND.
4	RS485 cable	Connect PTZ to control external PTZ and so on. The yellow cable is RS485A and the orange one is RS485B.
5	GPS port	Connect external GMouse to receive satellite positioning signals.
6	RS232 port	Connect PC to debug the device.
7	Network port	Connect standard Ethernet cable to access the device to the network.
8	Power input port	<p>Input DC 24V. Be sure to power the device according to the label instruction.</p>  <p>CAUTION</p> <p>Power supply not according to the label instruction will lead to device damage.</p>

2.3 Installing the Device

2.3.1 Installing TF Card/SIM Card

Step 1 Remove the device protective cover with a screwdriver.

You can see the TF1/TF2 slots and SIM1/SIM2 slots.

Step 2 Install the TF card/SIM card as needed.

 **NOTE**

If you need to change the TF card/SIM card, press the card and it pops up automatically.

- Insert the TF card into the corresponding slot according to the direction shown in Figure 2-3, push the card into the slot, and then press to fix it.

Figure 2-3 Installing TF card



- Insert the SIM card into the corresponding slot according to the direction shown in Figure 2-4, push the card into the slot, and then press to fix it. If only one SIM card is installed, it is recommended to use the SIM1 slot.

Figure 2-4 Installing SIM card



Step 3 Install the cover and tighten the screws.

2.3.2 Installing Device on Tripod

After assembling the tripod, the device can be installed on the tripod to facilitate user operation and shooting.

 **NOTE**

The tripod is not the standard accessory. You need to buy it separately.

Step 1 Assembling the tripod.

- 1) Take out the tripod, press the foot tube button and flip the tube about 150° in the direction shown in the arrow of Figure 2-5.

Figure 2-5 Tripod

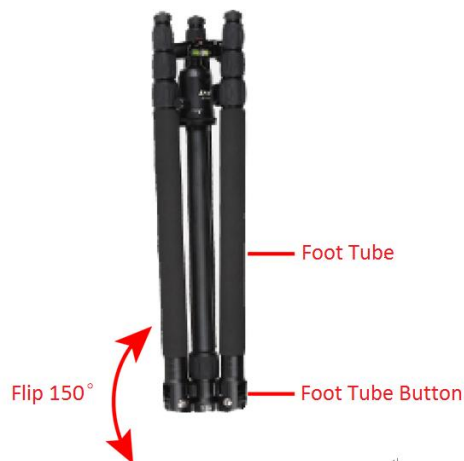

- 2) Repeat 1). Flip the rest two foot tubes and push the tube to the appropriate angle according to the shooting environment.
- 3) Adjust the tripod to the appropriate height by adjusting the knob.
The expanded tripod is shown in Figure 2-6. For detailed introductions, see Table 2-5.

Figure 2-6 Expanded tripod



Table 2-5 Tripod Description

Name	Description
External level	For placing the external camera. The angle of the level can be adjusted by adjusting the rotating button next to the external level.
Fastening button	To lock the external level.
Lock button	Lock the PTZ to prevent it from rotating.
Axis lock button	Freely adjust the PTZ to the required height for shooting.
Foot tube button	Press the button to adjust the external angle of the foot tube flexibly to adapt to different shooting environment.
Tube adjusting knob	To adjust the length of the foot tube.

Step 2 Installing the device.

- 1) Rotate the fastening button and remove the external level of the tripod. The mounting tray of the device can be installed on the PTZ only after removing the external level.
- 2) Install the tray on the PTZ and adjust to the appropriate position, then rotate the fastening button to fix the tray.

Figure 2-7 Fix the mounting tray



- 3) The device is placed on the mounting tray and attached to the tray by magnetic force.

Figure 2-8 Device placement



2.4 Operating the Battery

See this section when you need to charge the battery or remove the battery.

2.4.1 Charging the Battery



Due to the physical properties of the battery, when the environment temperature is above or below the specified temperature, the device may appear to be slow to charge, unable to charge or abnormal discharge.

When the battery is full, it can support device normal work for up to 9 hours continuously. When the battery is insufficient, connect the device to the power supply with the power adapter and the battery can be recharged through the device. The charging status can be seen on the OLED screen.



- You can also take out the battery and charge it through the recharge stand. For details, see the user's manual of the recharge stand for details. For detailed operation to remove the battery, see "2.4.2 Removing the Battery."
- The recharge stand is not the standard accessory. You need to buy it separately.

2.4.2 Removing the Battery

Step 1 Removing the battery.

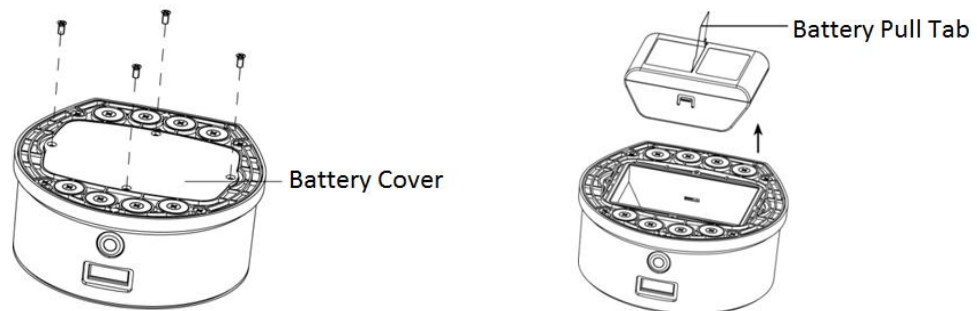

- ① Remove the screws from the device base with the screwdriver and remove the battery cover.
- ② Remove the battery with a quick pull-up of the battery pull tab.

Step 2 Installing the battery.



When installing the battery, make sure the screws are tightened, otherwise it will affect the battery contact and waterproof reliability of the device.

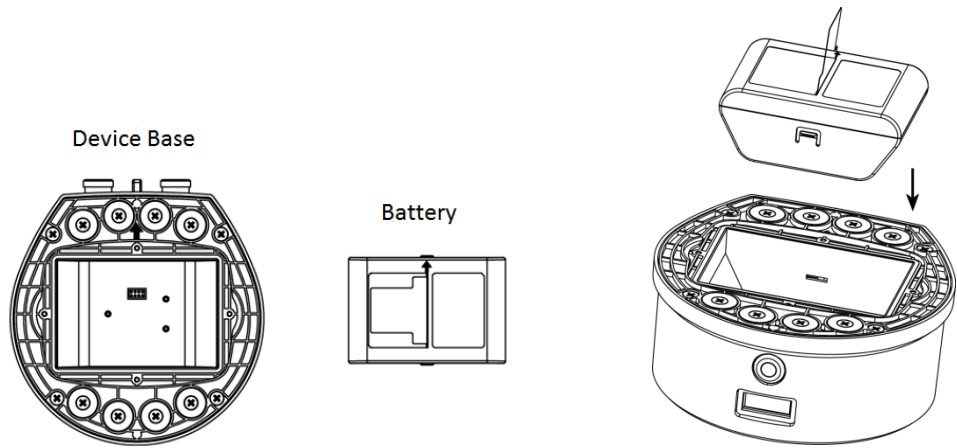

- ① Align the arrow on the battery to the arrow on the device base.
- ② Put down the battery by carrying the pull tab until the battery is stuck.

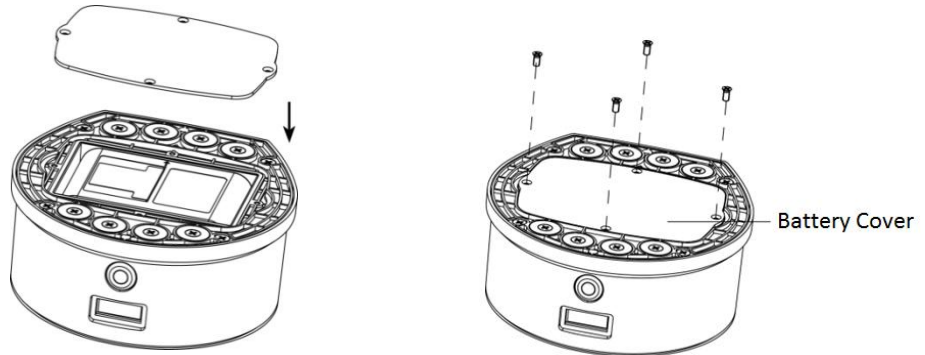

- ③ Align the battery cover to the mounting holes on the device base and install it.
- ④ Install the screws back into the mounting holes and tighten them.

3 Startup and Shutdown

3.1 Startup

When the power supply is connected or the battery is sufficient, press the power button and the OLED screen shows **Starting**. As shown in Figure 3-1.

Figure 3-1 Startup display on OLED screen

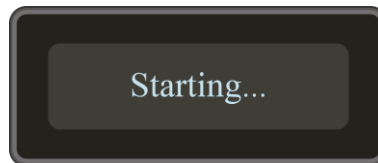

3.2 Shutdown

When the device is switched on, holding down the device power button and the OLED screen displays **Shutdown now!** As shown in Figure 3-2.

Figure 3-2 Shutdown display on OLED screen

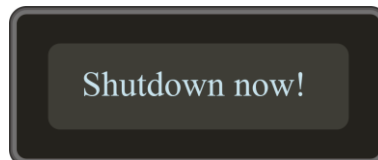

4 Basic Configuration

NOTE

- The device supports logging into the Web interface through a variety of browsers, such as Internet Explorer.
- You can also initialize the device and modify the IP address with a quick configuration tool. For details, see the instructions of the quick configuration tool.

4.1 Initializing the Device

When log in the device for the first time or restore the device to factory defaults, it needs to be initialized. The device can be configured and operated only after initialization.

Make ensure that the network connection between PC and device is normal.

Step 1 Open the browser, enter the IP address of the device which you need to log in (factory default IP address: 192.168.1.108). Press Enter key.

The **Enter Password** interface is displayed. See Figure 4-1.

Figure 4-1 Password settings



Device Initialization

1 Enter Password 2 Password Protection 3 Successful

Username admin

New Password

Low Middle High

It is 8 to 32-digit containing letter(s), number (s), symbol(s). It contains at least two types.

Confirm Password

Next

Step 2 Enter the new password and confirm the password. Click **Next**.

The **Password Protection** interface is displayed. See Figure 4-2.

Figure 4-2 Password protection

Device Initialization

1 Enter Password 2 Password Protection 3 Successful

Email (To reset password)

Security Question

Question 1: What is your favorite children's book?

Answer:

Question 2: What was the first name of your first boss?

Answer:

Question 3: What is the name of your favorite fruit?

Answer:

Next

Step 3 Select to enable password protection or not according to practical needs.

- Enable: Select the **Email** check box and enter the email address.
- Disable: Clear the **Email** check box.

Step 4 Click **Next**.

The **Successful** interface is displayed. See Figure 4-3.

Figure 4-3 Successful

Device Initialization

1 Enter Password 2 Password Protection 3 Successful

✓ Successfully initialized the device!

Ok

Step 5 Click **OK**.

4.2 Logging in Web

Log in Web to do operations such as configuring the device.

Step 1 Open the browser, enter the IP address into the address bar and press Enter key.
The login box pops up. See of the device is 192.168.2.108.

Figure 4-4.

 NOTE

- When log in Web for the first time, the IP address of the device is 192.168.1.108. If the IP address has been modified according to network planning, the IP address of the device shall be the modified one. For detailed operations to modify IP address, see "4.3 IP Address."
- When Pad is connected to the network through the shared hotspot of the device, the IP address of the device is 192.168.2.108.

Figure 4-4 Login box



Step 2 Enter user name and the password set in initialization.

Step 3 Click **Login**.

The Web main interface is displayed. See Figure 4-5.

 NOTE

- When log in for the first time, you need to install the control according to system prompt.
- The main stream and sub stream can be identified through the M/S signs on the top left corner. M means main stream and S means sub stream.
- Enter admin in the **Username** box and **Forgot password** is displayed. If you forget the admin password, click **Forgot password** to retrieve it. For details, see "6.5.2.3 Reset Password."

Figure 4-5 Web main interface

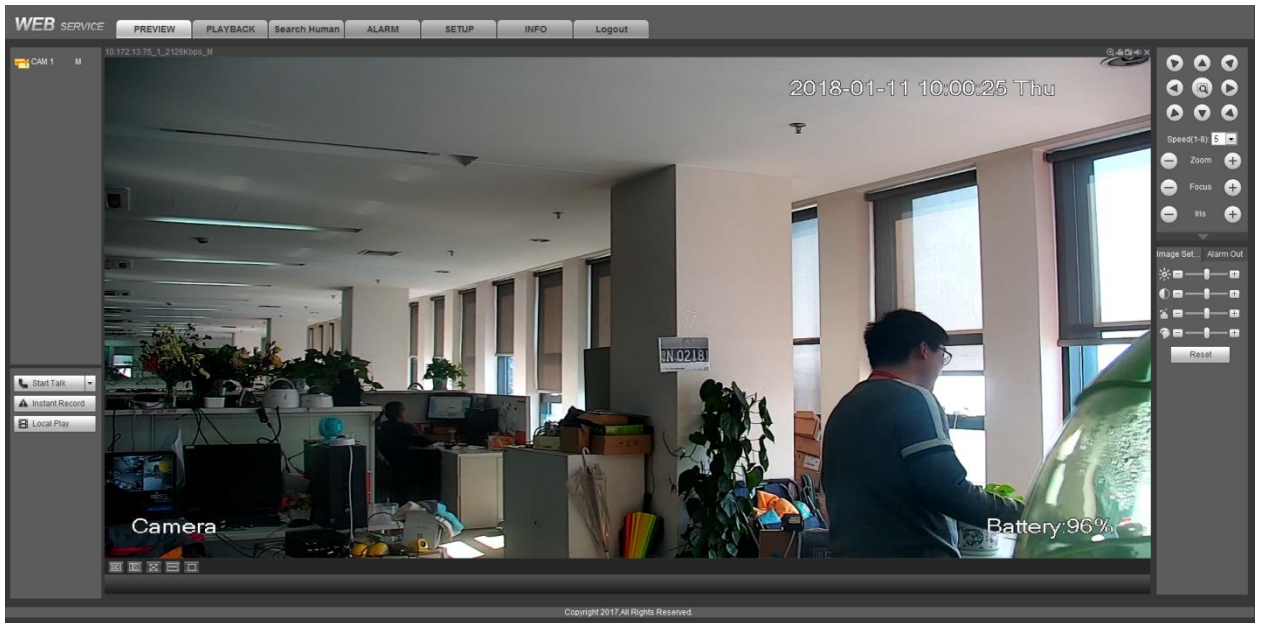

4.3 IP Address Settings

Configure the IP address and DNS server of the device according to the needs to ensure that the other devices in the network can be interlinked.

Make sure that the device is properly connected to the network.

Step 1 Select **SETUP > NETWORK > TCP/IP**.

The **TCP/IP** interface is displayed. See Figure 4-6.



Figure 4-6 TCP/IP

IP Version	IPv4
MAC Address	76 . 4A . 35 . 7D . 5A . E2
Mode	<input checked="" type="radio"/> Static <input type="radio"/> DHCP
IP Address	172 . 9 . 1 . 191
Subnet Mask	255 . 255 . 0 . 0
Default Gateway	172 . 9 . 0 . 1
Preferred DNS	8 . 8 . 8 . 8
Alternate DNS	8 . 8 . 4 . 4
MTU	1500
<input type="checkbox"/> LAN Download	

Save Refresh Default

Step 2 Set the parameters. For detailed parameter description, see Table 4-1.

Table 4-1 Parameter description

Parameter	Description
IP Version	IPv4 and IPv6 address formats are available, and both IP addresses are currently supported.  NOTE For IPv6 version, IP address, default gateway, preferred DNS and standby DNS shall be 128 bits. Not null.
MAC Address	Display the MAC address of the host. Unchangeable.
Mode	<ul style="list-style-type: none"> • Static Manually set the IP address, subnet mask and gateway • DHCP Automatically acquire IP function. When DHCP is enabled, IP address, subnet mask and default gateway cannot be set. The current IP address can be viewed no matter DHCP is enabled or not.
IP Address	Modify device IP address according to network plan, and set corresponding subnet mask and default gateway.  NOTE IP address and default gateway must be in the same network.
Subnet Mask	
Default Gateway	
Preferred DNS	IP address of DNS server.
Alternate DNS	IP address of the backup DNS server.
MTU	MTU value of the network card. Default is 1,500 bytes.
LAN Download	If network bandwidth allows, the speed of high-speed download is 1.5 -2 times as much as the speed of normal download.

Step 3 Click **Save**.

4.4 Basic Information Settings

Set the basic information of the device, including native settings, date settings, screen-out settings and GPS settings.

4.4.1 Native Information Settings

Set the basic information of the device, such as device language and video format.

Step 1 Select **SETUP > SYSTEM > GENERAL > General**.

The **General** interface is displayed. See Figure 4-7.

Figure 4-7 General settings

The screenshot shows a settings menu with the following fields and values:

- Language: ENGLISH
- Video Standard: PAL
- Storage Card Full: Overwrite
- Pack Duration: 30 min.
- License No.: (empty)
- IPC Time Sync: 24 Hours

Buttons: Save, Refresh, Default

Step 2 Set the parameters. For detailed parameter description, see Table 4-2.

Table 4-2 Description of local setting parameters

Parameter	Description
Language	Display menu language of the system.
Video Standard	Display the video encoding way.
Storage Card Full	The recording strategies when memory card is full include stop and overwrite. <ul style="list-style-type: none"> • Stop: When the current memory card is full and no extra free memory card is available, stop video recording. • Overwrite: When the current memory card is full and no extra free memory card is available, cover the earliest record files in cycle.
Pack Duration	The time length of each record file. It can be up to 120 minutes.
License No.	The license plate number of the car in which the device locates.
IPC Time Sync	Select the check box and enter the time interval for the device to synchronize time to IPC.

Step 3 Click **Save**.

4.4.2 System Date Settings

Set the system date, such as date format, time format and timing mode.

Step 1 Select **SETUP > SYSTEM > GENERAL > Date & Time**.

The **Date & Time** interface is displayed. See Figure 4-8.

Figure 4-8 Date & Time settings

Step 2 Set the parameters. For detailed parameter description, see Table 4-3.

Table 4-3 Description of date setting parameters

Parameter	Description
Date Format	Set the date display format, including YYYY MM DD, MM DD YYYY and DD MM YYYY.
Time Format	Set the time format of the device, including 24-hour system and 12-hour system.
System Time	Set the current system date and system time.  CAUTION The changed system time needs to be outside of the recording time in the memory card. Otherwise, it may cause the video to be unavailable. For example, there is a video of 10:00 A.M. to 12:00 P.M. in the memory card. When the system time is changed to 11:00 A.M., the video between 11:00 A.M. and 12:00 P.M. cannot be viewed.
Sync PC	Click Sync PC . The system automatically synchronizes the time to the PC logged to the Web page.
Time Zone	This parameter needs to be set when the Timing Mode is set to GPS or NTP . Set the current time zone of the device.
DST	In some counties or regions, DST is adopted. Select whether to enable DST or not according to the actual situation of the device. 1. Select DST check box to enable it. 2. Set the DST type, begin time and end time according to local law.
Timing Mode	Select the timing mode of the device, including DSS, GPS and NTP. <ul style="list-style-type: none"> When selecting DSS in the Time Mode list, the device automatically synchronizes the time from the registered DSS platform. When selecting GPS in the Time Mode list, the device automatically synchronizes time from the satellite via GPS. When selecting NTP in the Time Mode list, the device automatically synchronizes the time from the set NTP server.

Parameter	Description
Server	This parameter needs to be set when timing mode is set to NTP.
Manual Update	After NTP is set, the device automatically synchronizes the time to NTP server.
Port	1. Select NTP in the drop-down box of Timing Mode .
Interval	2. Set parameters. <ul style="list-style-type: none"> ◇ Server: Enter the IP address of NTP server. ◇ Manual update: Click Manual Update to immediately synchronize the device time to NTP server. ◇ Port: The system only supports TCP transmission, and the port limit is 123. ◇ Interval: The interval that the device synchronizes the time to NTP server. The maximum update cycle is 65535 minutes.

Step 3 Click **Save**.

4.4.3 Screen-out Mode Settings

Step 1 Select **SETUP > SYSTEM > GENERAL > LED off**.

The **LED off** interface is displayed. See Figure 4-9.

Figure 4-9 LED-off settings

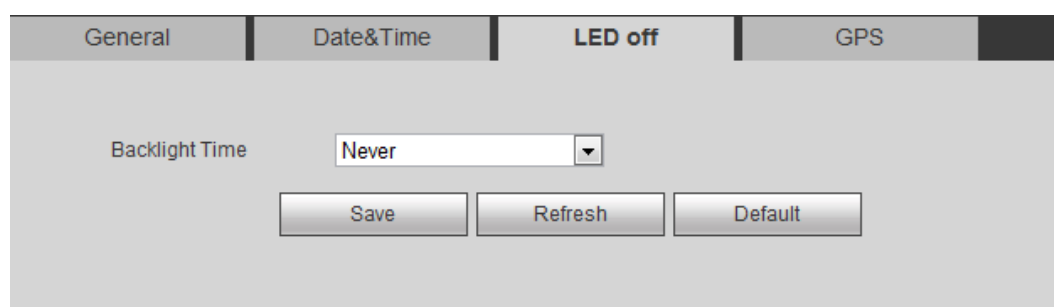

Step 2 Selecting the LED off mode.

- Never: The LED screen of the device is always bright.
- Customized: Select **Customized** in the **Backlight Time** list, and set the backlight time. The value range of backlight time is 5 seconds to 300 seconds. When the backlight time of the device reaches the set time, the LED screen is extinguished, and when the LED screen is out, press the power button or charge the device to wake up the device.

Step 3 Click **Save**.

4.4.4 GPS Settings

Step 1 Select **SETUP > SYSTEM > GENERAL > GPS**.

The **GPS** interface is displayed. See Figure 4-10.

Figure 4-10 GPS configuration

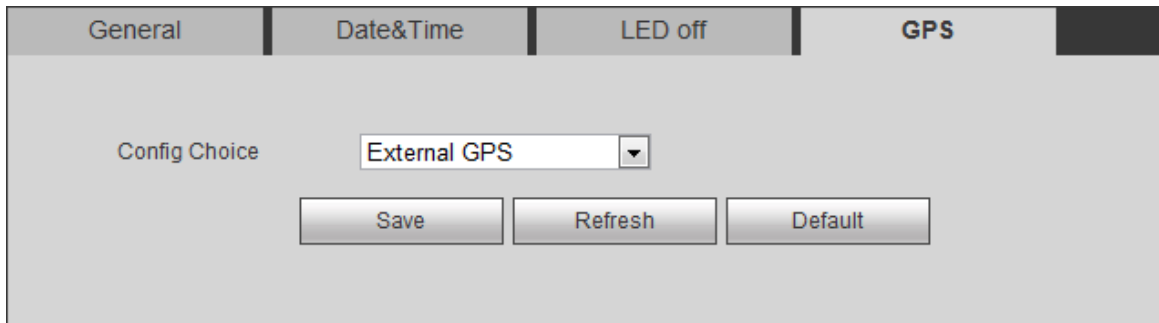

Step 2 Select the GPS installation mode, including **Built-in GPS** and **External GPS**.

When you select **External GPS**, an external GMouse shall be already connected.

Step 3 Click **Save**.

4.5 Record Control Settings

Video recording can be divided into automatic recording and manual recording, and you can also set to enable snapshot or not.

- Automatic recording: Taking records automatically according to the selected record type and planned record time.
- Manual recording: 24-hour continuous normal recording in the channel.
- Close: Disable record or snapshot.



CAUTION

Manual recording requires the user to have the permission to access storage setting. Confirm that the device has installed the properly formatted memory card.

Step 1 Select **SETUP > STORAGE > RECORD**.

The **Record** interface is displayed. See Figure 4-11.

Figure 4-11 Record control

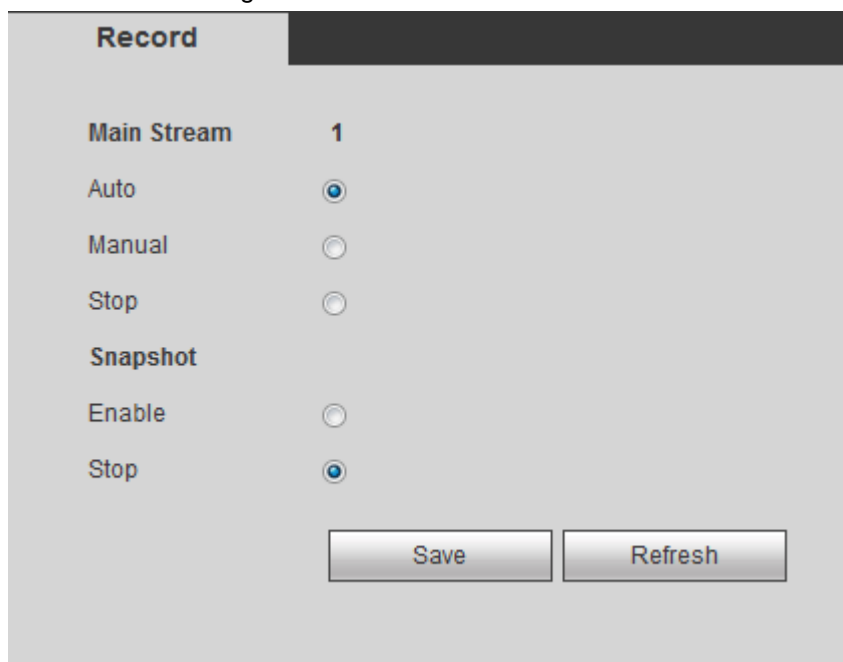

Step 2 Set the parameters. For detailed parameter description, see Table 4-4.

Table 4-4 Description of record control parameters

Parameter	Description
Channel	List the device channel number.
Automatic/Manual/Stop	Set the record type, including manual, automatic and stop. <ul style="list-style-type: none"> Manual: Highest priority. No matter what state the channel is in, it starts normal recording when Manual is selected. Automatic: Start recording according to the set record type (regular, motion detect or alarm). Stop: The channel stops recording.
Enable/Stop	Enable or disable regular snapshot in the channel.

Step 3 Click **Save**.

4.6 Record Plan Settings

The default record mode is 24-hour continuous recording. You can set the record time and record type according to the needs.

Automatic recording in the channel shall be enabled. For details, see "4.5 Record Control Settings."

Step 1 Select **SETUP > STORAGE > SCHEDULE > Record**.

The **Record** interface is displayed. See Figure 4-12.

Figure 4-12 Record plan

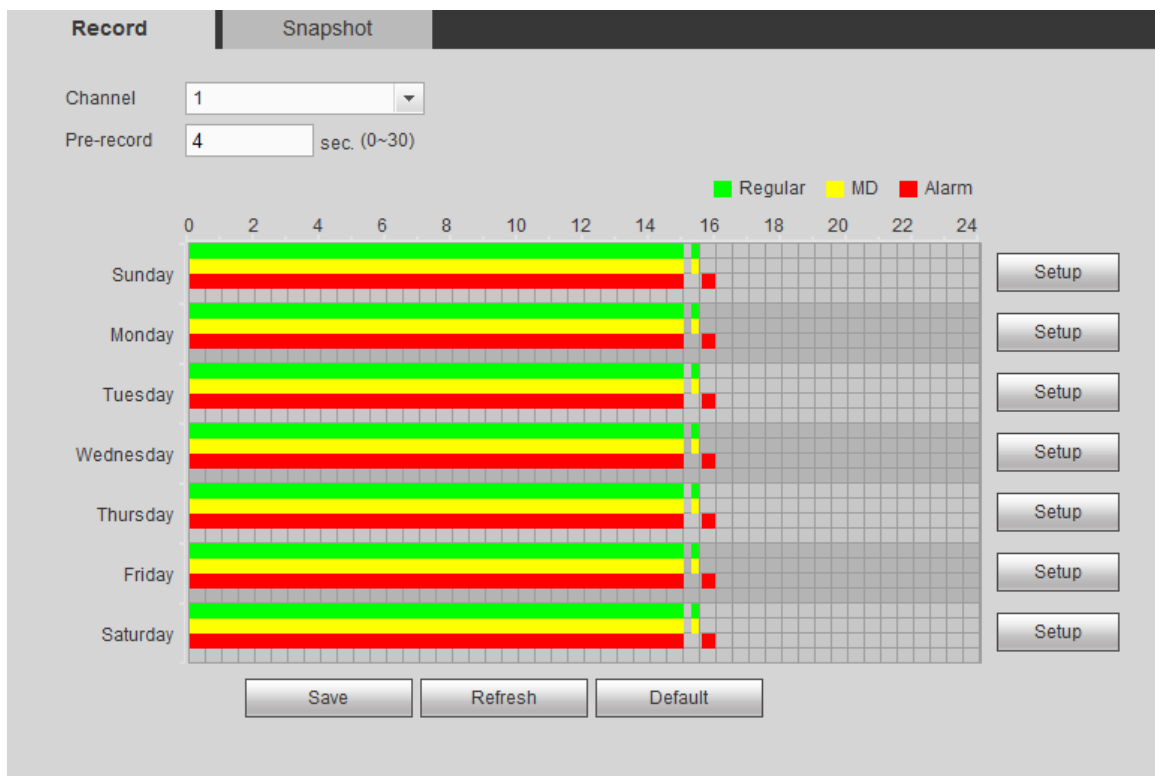

Step 2 Select the **Channel** and enter **Pre-record**.

Starts to take record 1 second - 30 seconds before the recording action (record time depends on the stream size).

Step 3 Set the time period.

1) Click the **Setup** corresponding to the weekday.

The **Setup** interface is displayed. See Figure 4-13.

Figure 4-13 Settings

The screenshot shows a window titled "Setup" with a close button in the top right corner. The window contains a table of settings for six time periods. Each row represents a time period with columns for start and end times, record type, MD, and Alarm. Below the table are checkboxes for days of the week: All, Sunday, Monday, Tuesday, Wednesday, Thursday, Friday, and Saturday. At the bottom of the window are "Save" and "Cancel" buttons.

Time Period	Start Time	End Time	Regular	MD	Alarm
Time Period1	00 : 00	15 : 00	<input checked="" type="checkbox"/>	<input checked="" type="checkbox"/>	<input checked="" type="checkbox"/>
Time Period2	15 : 15	15 : 30	<input checked="" type="checkbox"/>	<input checked="" type="checkbox"/>	<input type="checkbox"/>
Time Period3	15 : 35	16 : 00	<input type="checkbox"/>	<input type="checkbox"/>	<input checked="" type="checkbox"/>
Time Period4	00 : 00	24 : 00	<input type="checkbox"/>	<input type="checkbox"/>	<input type="checkbox"/>
Time Period5	00 : 00	24 : 00	<input type="checkbox"/>	<input type="checkbox"/>	<input type="checkbox"/>
Time Period6	00 : 00	24 : 00	<input type="checkbox"/>	<input type="checkbox"/>	<input type="checkbox"/>

All Sunday Monday Tuesday Wednesday Thursday Friday Saturday

Save Cancel

- 2) Select the needed record type and enter the time period. Select the weekdays as needed.

 NOTE

When the alarm type is set to **MD** and **Alarm**, the alarm linked recording function shall be enabled. For details, see "6.3 Alarm Event Settings." For example: When the alarm type is **MD**, select the **Enable Channel** check box and choose the channel number.

- 3) Click **Save**.
The record plan interface will display the corresponding time plan figure to give a more visual view of the plan.

Step 4 Click **Save**.

4.7 Snapshot Plan Settings

Set the snapshot plan of the channel. The system will do automatic snapshot during the set time period.

- The snapshot function of the corresponding channel shall be enabled. For details, see "4.5 Record Control Settings ."
- The snapshot parameters shall be set. For details, see "6.2.1.2 Picture Stream Settings."

Step 1 Select **SETUP > STORAGE > SCHEDULE > Snapshot**.

The **Snapshot** interface is displayed. See Figure 4-14.

Figure 4-14 Snapshot plan

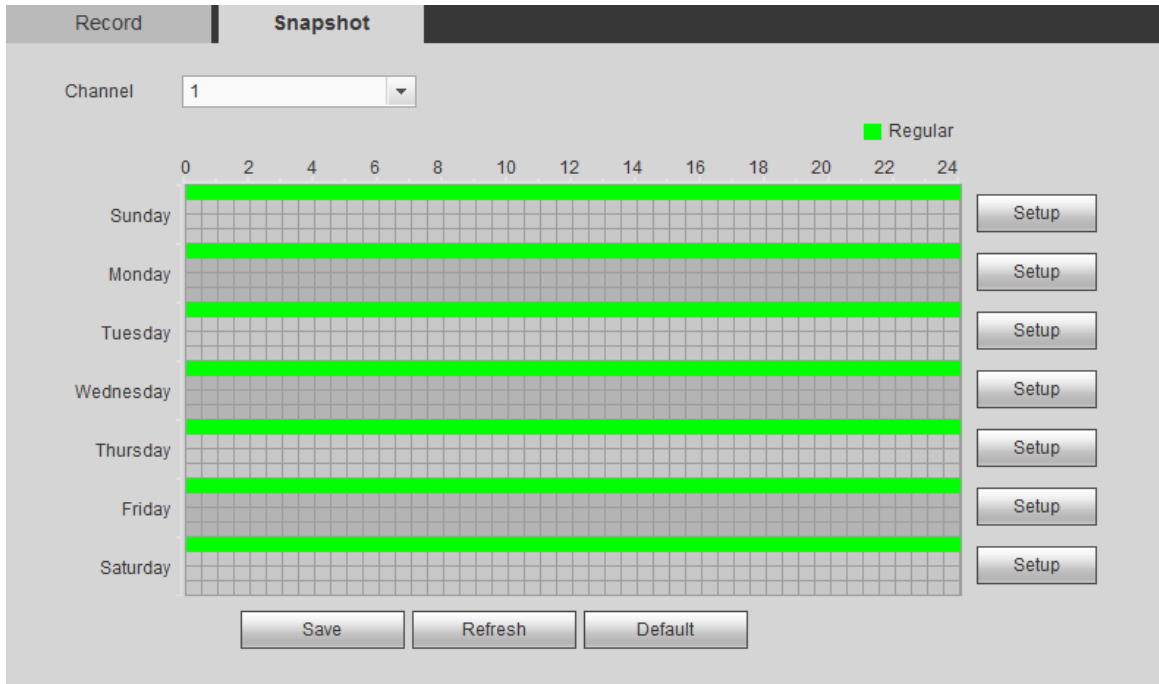

Step 2 Set the snapshot time period.

- 1) Click the **Setup** corresponding to the weekday.
The **Setup** interface is displayed. See Figure 4-15.

Figure 4-15 Settings

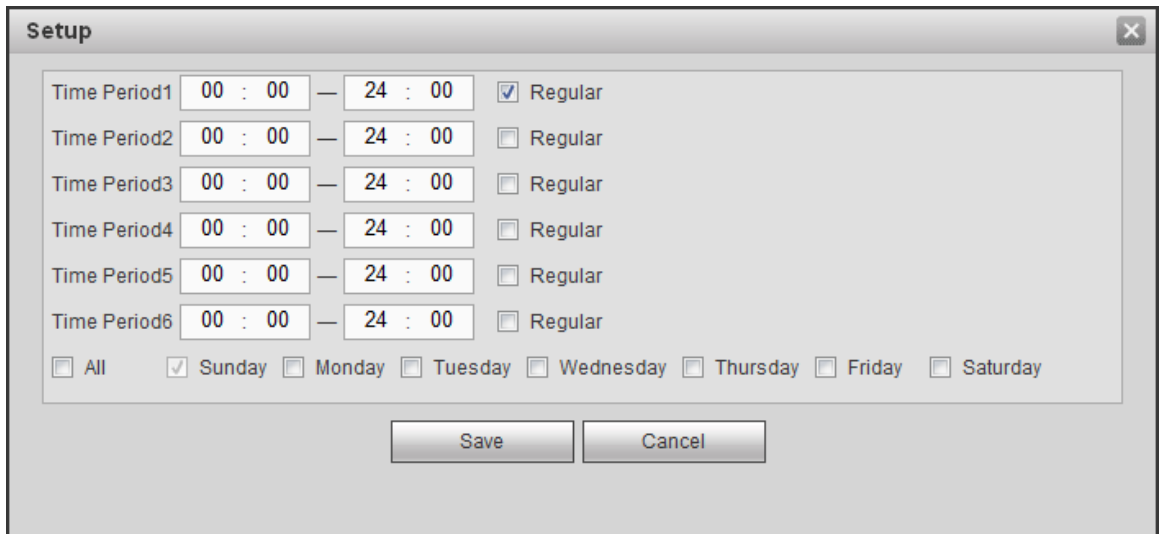

- 2) Select the snapshot type and enter the time period. Select the weekdays as needed.
- 3) Click **Save**.
The snapshot plan interface will display the corresponding time plan figure to give a more visual view of the plan.

Step 3 Click **Save**.

5 Business Operations

5.1 Preview

Log in Web and the **Preview** interface is displayed. See Figure 5-1.

Figure 5-1 Preview interface

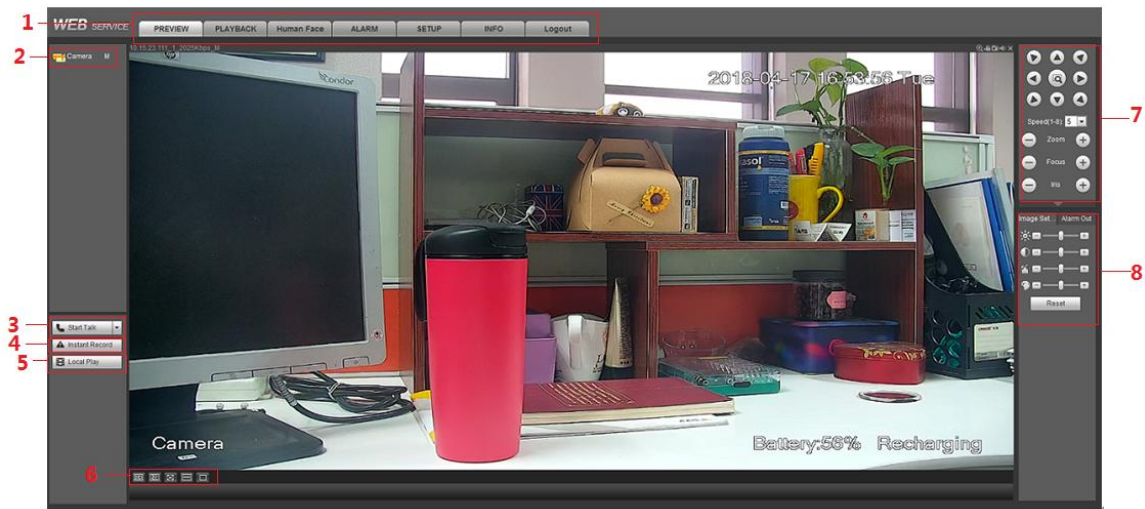



Table 5-1 Description of the preview interface parameters

No	Name	Description
1	System Menu	Including preview, playback, human face, alarm, setting, info and logout.
2	Real-time Monitoring Channel	For details, see "5.1.1 Real-Time Monitoring Channel."
3	Start Talk	For details, see "5.1.2 Voice Intercom."
4	Instant Record	Click Instant Record , the record mode is changed to manual and the icon is  . Click Instant Record again and the record mode changes back to automatic. NOTE <ul style="list-style-type: none"> Only the main stream supports emergency record. The emergency record files are kept in the SD card of the device.
5	Local Play	Play back the records saved in PC in the format of .dav. Click Local Play and select the record file you need to play in the pop-up dialogue box. Click Open to start record play.

No	Name	Description
6	Monitoring Window Switch	<ul style="list-style-type: none"> From left to right, it shows: Picture quality, fluency, full-screen, vertical synchronization and window split mode. The priority of image fluency or real-time performance can be flexibly adjusted in real-time monitoring. Fluency emphasizes the fluency of record images and real-time performance emphasizes real-time, which can meet the needs of different users. Window split mode only supports single window.
7	PTZ Console	For details, see "5.1.3 PTZ Console."
8	Image Setup/Alarm Output	For details, see "5.1.4 Image/Alarm Settings."

5.1.1 Real-Time Monitoring Channel

Monitoring channel list is displayed. The channel names of the sensor are displayed.

Figure 5-2 Monitor channel

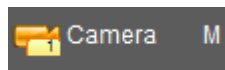



Monitoring Channel Operations

Click the monitoring channel and the real-time monitoring images are displayed. See Figure 5-3.

Figure 5-3 Monitoring window



Table 5-2 Description of the monitoring window parameters

Parameter	Description
Device information	The upper left corner of the monitor screen shows the device's IP address, channel number, bit stream and decoding mode (M is main stream and S is sub stream).
Partial enlargement	Click this icon and drag to select any area in the video window, this area can be enlarged. Click this icon again or right-click the mouse, the state can be restored.
Local record	Click this icon to start recording. Click this icon again to stop recording.  NOTE The default record storage path: C:\RecordDownload. You can enter the Storage Path interface to modify it. For details, see "6.2.1.4 Storage Path Settings."
Snapshot	Click this icon to start snapshot.  NOTE The default picture storage path: C:\PictureDownload. You can enter the Storage Path interface to modify it. For details, see "6.2.1.4 Storage Path Settings."
Audio	Enable or disable audio. If the audio is disabled, there is no sound in monitoring.
Closing the record	Close the current record monitoring.

Switching Bit stream

The system supports to switch the main stream and sub stream of the real-time monitoring channel. See Figure 5-4.

Figure 5-4 Switching bit stream

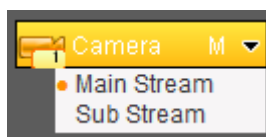

5.1.2 Voice Intercom

Realize the bidirectional communication between the device and the client.

Figure 5-5 Voice intercom

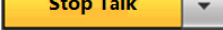

- Click **Start Talk** to enable the voice intercom with the device.
- Click the drop-down arrow and you can choose the intercom mode, including DEFAULT, G711a and PCM.

- When voice intercom is enabled, the **Start Talk** icon changes to . Click **Stop Talk** and you can end the voice intercom.

5.1.3 PTZ Console

When the monitoring screen is open, through the PTZ Console, you can operate the PTZ direction, step, zoom, focus, iris, preset point, tour, pattern, scan, pan rotation, auxiliary functions, light, fog clear and power mode. See Figure 5-6.



- PTZ rotation supports 8 directions, including up, down, left, right, top left, top right, bottom left and bottom right.
- The step is mainly used in the direction operation, and the larger the value, the faster the rotational speed. For example, the rotational speed of step 8 is much faster than that of step 1.
- Click  /  to display or hide the PTZ setting and menu.

Figure 5-6 PTZ console



5.1.3.1 PTZ Settings

When the monitoring screen is open, you can set functions such as scan, preset point, tour, pattern and auxiliary functions. See Figure 5-7. For details, see Table 5-3.

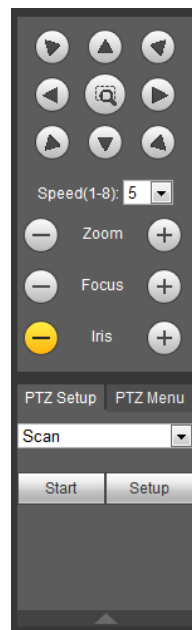
Figure 5-7 PTZ settings

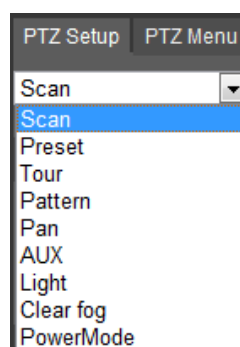



Table 5-3 Parameters of PTZ settings

Parameter	Description
Scan	<p>When linear scan is enabled after setting, the device automatically scans at a certain speed between the set left and right boundaries. The system supports 1 linear scan at most.</p> <ol style="list-style-type: none"> 1. Select Scan in the list and click Setup. Buttons of Set Left and Set Right are displayed. 2. Through the operation of PTZ console, turn the camera to the left boundary as needed and click Set Left. Turn the camera to the right boundary as needed and click Set Right. 3. Click Start to enable the linear scan. Click Stop to end the linear scan.
Preset	<p>After setting the preset point, the device can be quickly positioned to the corresponding position by viewing the preset point. The preset point includes parameters such as PTZ horizontal angle, slope angle and focal length of the device lens. The system supports up to 255 preset points.</p> <ol style="list-style-type: none"> 1. Select Goto and turn the camera to the needed monitoring direction through the PTZ console. 2. Enter the value of preset points in the input box of preset point. 3. Click Add to complete the adding of preset points. 4. Enter value in the input box of preset point, and click View. The camera can automatically turn to the position of the preset point. Click Del to cancel this preset point.
Tour	<p>Start the tour after the Tour is set. The device automatically follows the order of the preset points and keeps rotating. The system supports to set 8 paths at most.</p> <ol style="list-style-type: none"> 1. Select Tour in the list and set the value of the path. 2. Click Start and enter the preset point value. 3. Click Add or Del to add or delete preset points in this path. <p> NOTE You can repeatedly click Add or Del to add or delete preset points in this path.</p> <ol style="list-style-type: none"> 4. Enter the value of the path and click Start. The camera rotates according to the path. Click Del to delete this point path.
Pattern	<p>Start the pattern after setting. The device will follow the set operating logs and keep rotating back and forth. The operating logs include information such as user's manual operation on PTZ, device zoom in and device zoom out. The system supports 5 paths at most.</p> <ol style="list-style-type: none"> 1. Select Pattern in the list and set the value. 2. Click Add. Buttons of Start Rec and Stop Rec are displayed. 3. Click Start Rec. Control the monitoring direction, zoom and focus of the camera through the operation of PTZ console. 4. Click Stop Rec to complete the setting. 5. Enter the pattern value and click Start. The camera rotates according to the set path. Click Stop to end the pattern.
Pan	<p>Select Pan in the list and click Start. The camera PTZ starts level 360-degree rotation continuously at a certain speed. Click Stop to end the level rotation.</p>

Parameter	Description
AUX	Select Aux in the list and enter the auxiliary function number. Click Aux On to enable the auxiliary function and click Aux Off to close the auxiliary function. <ul style="list-style-type: none"> ● Number 1: Enable or disable the heating fog clear function. ● Number 2: Enable or disable the light function.
Light	Lighting control including automatic mode and manual mode, select according to the practical needs. The system will automatically save the configuration of the lighting control mode. The device will automatically use the last saved lighting control mode when it is switched on next time. <ul style="list-style-type: none"> ● Automatic mode: The system automatically controls the opening and closing of lamplight according to the ambient light. Select Light and set it to AutoMode. ● Manual mode: Manually control the opening and closing of lamplight. Select Light and set it to ManualMode. Click On to open lighting and click Off to close lighting.
Clear fog	Select Clear Fog in the list and click On to enable the heating module. Click Off to close the heating module.
Power Mode	Select Power Mode in the list and click On to enable the low power mode. Click Off to close the low power mode and the preview record shows energy saving closed.

5.1.3.2 PTZ Menu

After enabling the PTZ menu function, the main menu will be displayed on the monitoring screen, including options such as camera settings, PTZ settings and system management. You can configure the device through the direction button and confirmation button.

Step 1 Open the monitoring screen.

Step 2 Click the **PTZ Menu** tab on the PTZ console.

The **PTZ Menu** interface is displayed. See Figure 5-8. For description of PTZ parameters, see Table 5-4.

Figure 5-8 PTZ menu

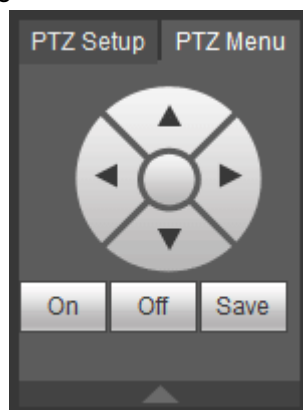



Table 5-4 Description of PTZ menu parameters

Parameter	Description
▲/▼	Up/down button. It controls which configuration item the cursor points to.

Parameter	Description
	Left/right button. Enable the cursor to set the configuration item to which the cursor is pointing.
On	Click On to open the PTZ menu. The main menu is displayed on the monitoring screen.
Off	Click Off to close the PTZ menu.
Save	It includes the below functions: <ul style="list-style-type: none"> Click Save to enter the submenu if there are submenus under the configuration item of the main menu. Move the cursor to the Return item and click Save to go back to the previous menu. Move the cursor to the Exit item and click Save to exit the menu.

Step 3 Click **On**.

The main menu is displayed on the monitoring screen. See Figure 5-9.

Figure 5-9 Main menu



Table 5-5 Description of main menu parameters

Parameter	Description
Camera settings	Move the cursor to Camera and click Save to enter the submenu. You can set the camera parameters, such as image, exposure, backlight, white balance, day/night change, zoom /focus, LED flash, anti-fog and restoring defaults.
PTZ settings	Move the cursor to PTZ and click Save to enter the submenu. You can set the PTZ functions, such as preset points, tour groups, linear scanning, pattern, horizontal rotation and PTZ restart.
System management	Move the cursor to System and click Save to enter the submenu. You can restore factory defaults, view camera software version and PTZ version.
Exit	Move the cursor to Exit and click Save to exit the menu.

Step 4 Click **Off** to close the PTZ menu.

5.1.4 Image/Alarm Settings

Configure the image display of the channel, such as adjusting the luminance and contrast, or open/close the alarm channel.

5.1.4.1 Image Display Settings

Adjust the channel luminance, contrast, saturation and chrominance.

Step 1 Open the monitoring screen.

Step 2 Click the **Image Setup** tab.

The **Image Setup** interface is displayed. See Figure 5-10.

Figure 5-10 Image configuration

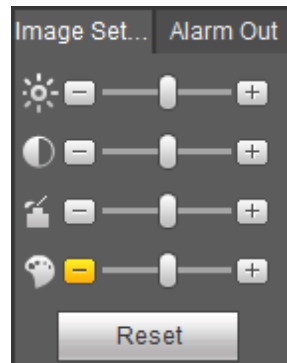

NOTE

Click **Reset** to clear the image parameter configuration.

Step 3 Set the parameters. For details, see Table 5-6.

Table 5-6 Description of image configuration parameters

Parameter	Description
Brightness	Adjust the image brightness. The higher the value, the brighter the image. You can adjust the brightness value according to practical situation.
Contrast	Adjust the image contrast. With the increase of this value, the contrast between the light and dark areas of the image becomes more obvious. You can adjust the contrast value according to practical situation.
Saturation	Adjust the image color. The higher the saturation value, the more vivid the color of the image. You can adjust the value according to practical situation.
Hue	Adjust the image hue. The higher the value, the brighter the color of the image. You can adjust the value according to practical situation.

5.1.4.2 Alarm Output Settings

Open or close the alarm signal of the corresponding channel.

Step 1 Open the monitoring screen.

Step 2 Click the **Alarm Out** tab.

The **Alarm Out** interface is displayed. See Figure 5-11.

Figure 5-11 Alarm output

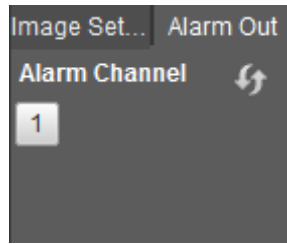

Step 3 Click the alarm channel to open the alarm signal.

The icon becomes orange after the alarm signal is open, such as .

 **NOTE**

Click  to refresh the alarm channel list.

5.2 Playback

You can play back or download record files on the playback interface.

Click the **PLAYBACK** tab. The **PLAYBACK** interface is displayed. See Figure 5-12.

Figure 5-12 Playback

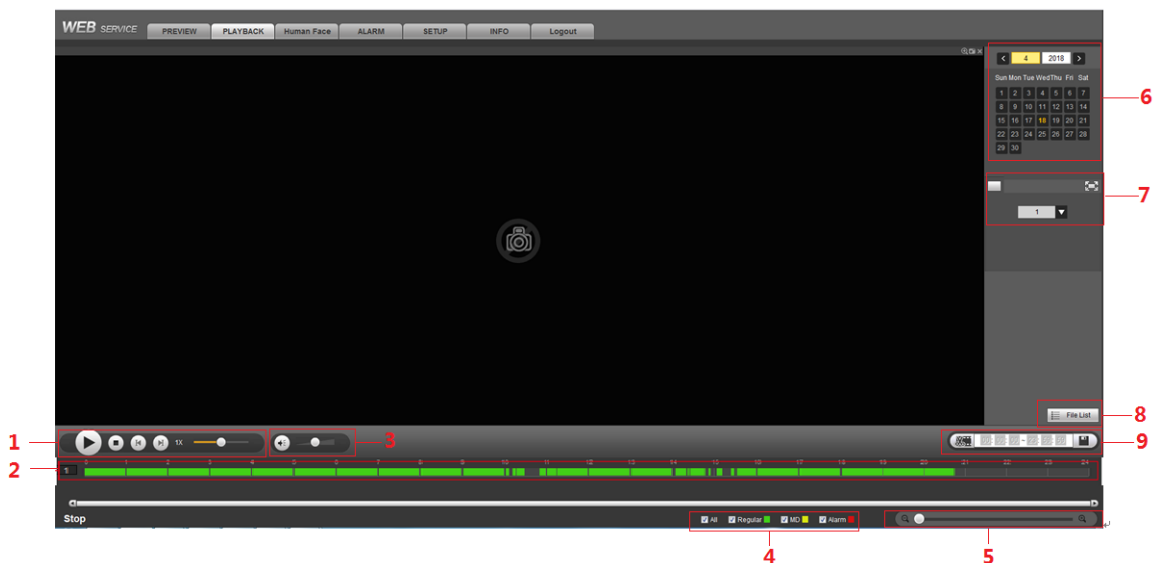







Table 5-7 Description of the record playback bar









No	Function	Description
1	Play control bar	For details, see "5.2.1 Control Bar."
2	Progress bar	Display record type and its time period. <ul style="list-style-type: none"> Click on the color area to start playback from that time point. Different types of record correspond to different colors. See the record type bar for the corresponding relations.
3	Volume bar	Control the volume, including the following two states: <ul style="list-style-type: none">  Mute.  Sound available and volume size can be adjusted.

No	Function	Description
4	Record type bar	Record type includes regular, motion detect and alarm. Select as needed.
5	Progress time control bar	Move the slider or click  /  to scale the time of progress bar.
6	Select date	Select record date. Yellow means the current system date and blue means the date with records.
7	Image split	<ul style="list-style-type: none"> Select image split mode and set the channel number corresponding to the playback window. Click  for full-screen display. Press Esc key to exit full-screen display.
8	File list	Click File List to play records by file, download records by file and time, and check the integrity of the record.
9	Record clip bar	Clip and save some part of the record. For details, see "5.2.3 Clipping Record Files."

5.2.1 Control Bar

For the description of play control during the play progress, see Table 5-8.



Table 5-8 Description of play control bar

Icon	Function	Description
	Play	It means the play is paused or no record is being played. Click this icon to switch to normal play and the icon becomes  .
	Stop playing	Click this icon to stop record playing.
	Last frame	Click this icon to play the last frame.  NOTE The playback shall be paused when using playing by frame.
	Next frame	Click this icon to play the next frame.  NOTE The Playback shall be paused when using playing by frame.
	Speed	Move the slider to adjust the record playback speed.

5.2.2 Playing back Records

Play back records by dates or files. Below operations are available when playing back the record:

- Click  on the top right corner. Drag to select any region in the video window and this region will be enlarged. Click the icon again or right-click to restore the original state.

- Click  on the top right corner to start snapshot.
- Click  on the top right corner to close video playback.

5.2.2.1 Playing back Records by Date

Step 1 Select the record date for query.

Step 2 Select the date with record, playback window and record type.

Figure 5-13 Record type



Step 3 Click  to start record playback.

5.2.2.2 Playing back Records by File

Step 1 Select the record date for query.

Step 2 Select the date with record and the playback window.

Step 3 Click **File List**.

The **File List** is displayed. See Figure 5-14.

Figure 5-14 File list

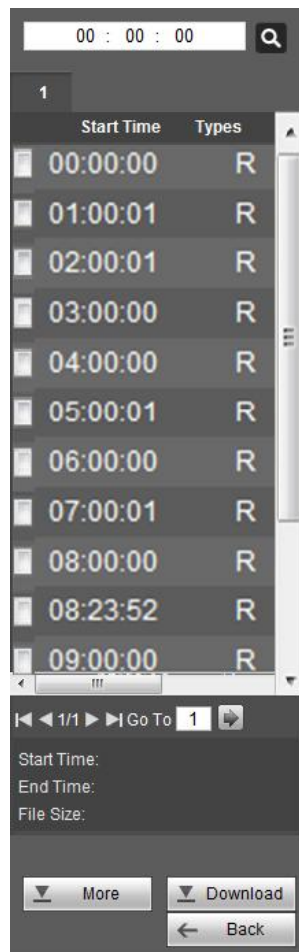

Step 4 Set the record start time and click . The queried record files are displayed.

Step 5 Double-click the record file to start playback.

 NOTE

- Select the record file and click **Download** to download the record needed. The default storage path is C:\RecordDownload. You can change the save path in the interface of **Path**.
- Click **More** to search records by file or time and download them to local PC. Check the watermark to see if the file has been tampered with. For details, see "5.2.4 Downloading Record Files."

5.2.3 Clipping Record Files

When you need to clip some part of the record and save to PC.

Step 1 Query record files through the calendar and time axis.

Step 2 Select the corresponding channel.

Step 3 The system supports two ways to clip the record:





- Option 1: Click . A slider like  and  will appear at the two ends of the time axis. Move the slider to the appropriate position, click , and you can clip and save the record in the slider interval.
- Option 2: Enter the start time and end time in the below input box. Click  to clip and save the record in the time period.

Figure 5-15 Clip and save



Step 4 The default storage path: RecordDownload. You can also change the storage path to save it in your specified folder.

Step 5 The system starts to download record file and the download progress is displayed.

 NOTE

Click  to cancel this operation.

5.2.4 Downloading Record Files

Click **More** to download record by file or time and check the watermark to see if the file has been tampered with.

5.2.4.1 Downloading by File

Download records by file.

Step 1 Click the **Download by File** tab.

The **Download by File** interface is displayed. See Figure 5-16.

Figure 5-16 Download by file

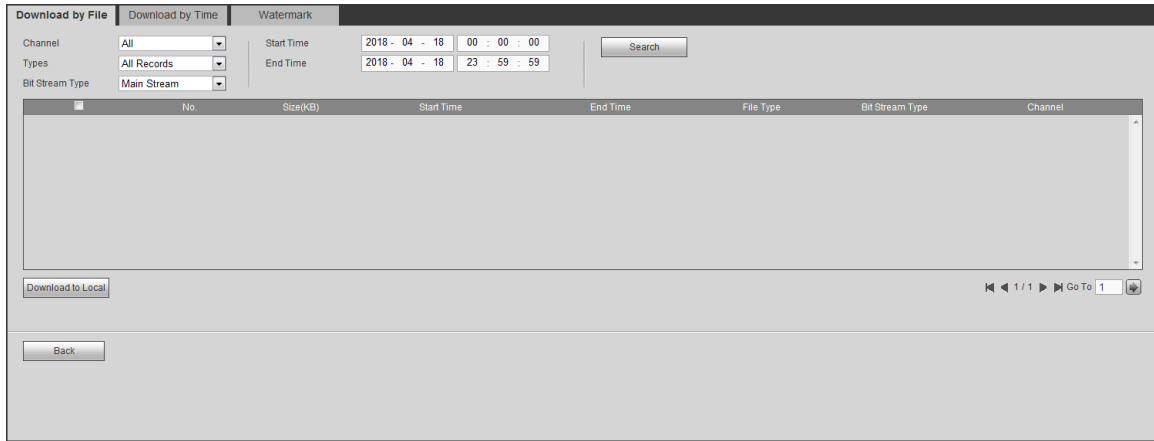

Step 2 Select the **Channel**, **Types** and **Bit Stream Type**, and enter the **Start Time** and **End Time** according to practical needs.



NOTE

- The system supports record file query through types of normal, motion detect, alarm and picture, and supports picture file query through car license number.
- The parameters might be different when searching for records through different types. See the actually displayed interfaces.

Step 3 Click **Search**.

The queried record file is displayed in the list.

Step 4 Select the file for download and click **Download to Local**.

A dialogue box of Download to Local is displayed. See Figure 5-17.

Figure 5-17 Download to local

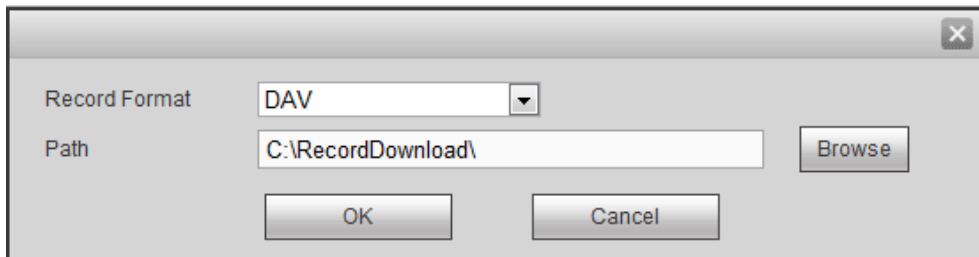

Step 5 Select **Record Format** and **Path**. Click **OK**.

The system starts to download and the progress is displayed. Completed is displayed when it is done.

5.2.4.2 Downloading by Time

Download record by time.

Step 1 Click the **Download by Time** tab.

The **Download by Time** interface is displayed. See Figure 5-18.

Figure 5-18 Download by time

Download by File | **Download by Time** | Watermark

Channel: 1 | Start Time: 2018 - 04 - 18 00 : 00 : 00
Bit Stream Type: Main Stream | End Time: 2018 - 04 - 18 23 : 59 : 59

Download to Local

Back

Step 2 Select **Channel** and **Bit Stream Type**, and then enter **Start Time** and **End Time**.

Step 3 Click **Download to Local**.

A dialogue box pops up. See Figure 5-17.

Step 4 Select the **Record Format** and **Path**. Click **OK**.

The system starts to download and the progress is displayed. Completed is displayed when it is done.

5.2.4.3 Watermark Verification

Check if the record file has been tampered with.

Step 1 Click the **Watermark** tab.

The **Watermark** interface is displayed. See Figure 5-19.

Figure 5-19 Watermark verification

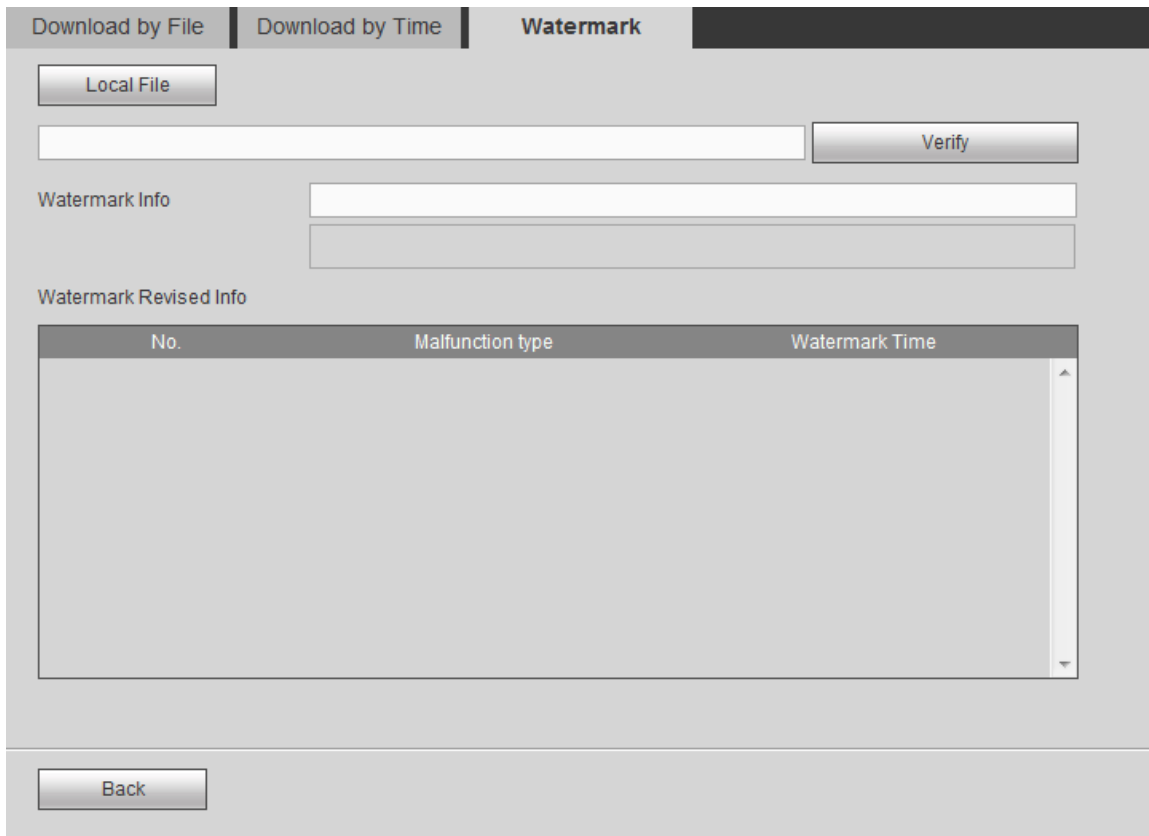

Step 2 Click **Local File** to select the file.

Step 3 Click **Verify**.

The progress and result is displayed. See Figure 5-20.

Figure 5-20 Watermark verification

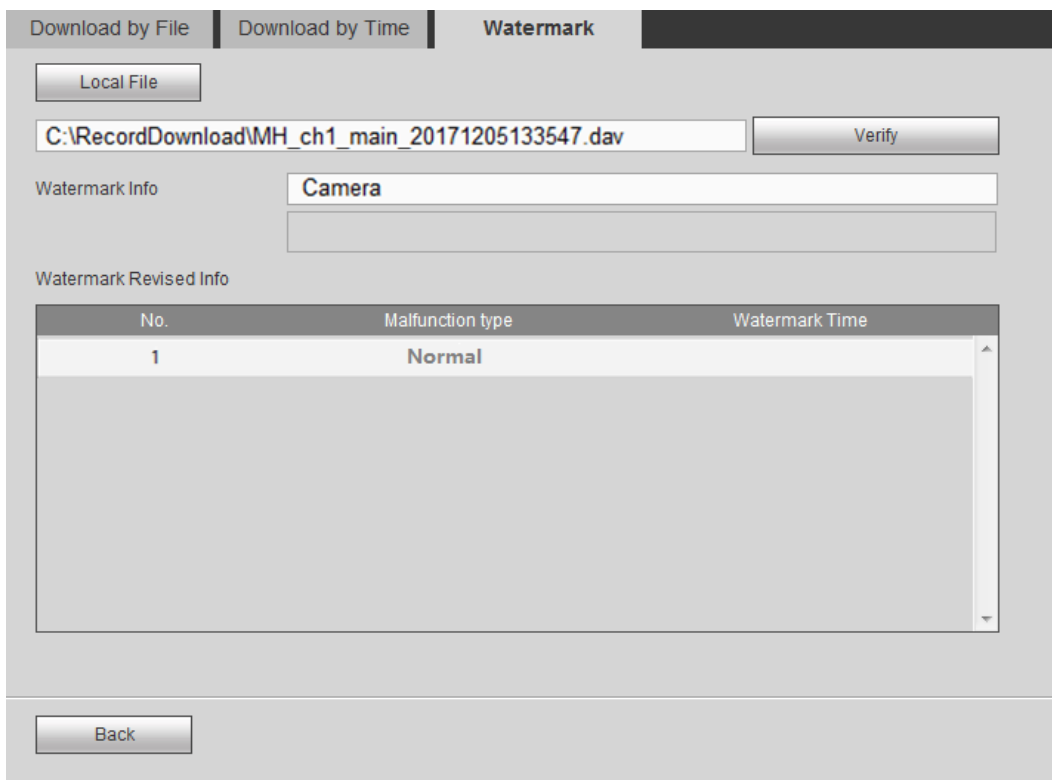

5.3 Face Image Query

Query and download the detected face images. Meanwhile, the record of the corresponding time can be played and downloaded.

The face detection function shall be enabled. For detailed operations, see the user's manual of the inter-machine.

Step 1 Click the **Human Face** tab.

The **Human Face** interface is displayed.

Step 2 Select year, month and date or enter the start time and end time. Click **Search**.

The face images recognized are displayed. See Figure 5-21.

 **NOTE**

Click **Clear** to empty the face images.

Figure 5-21 Face query

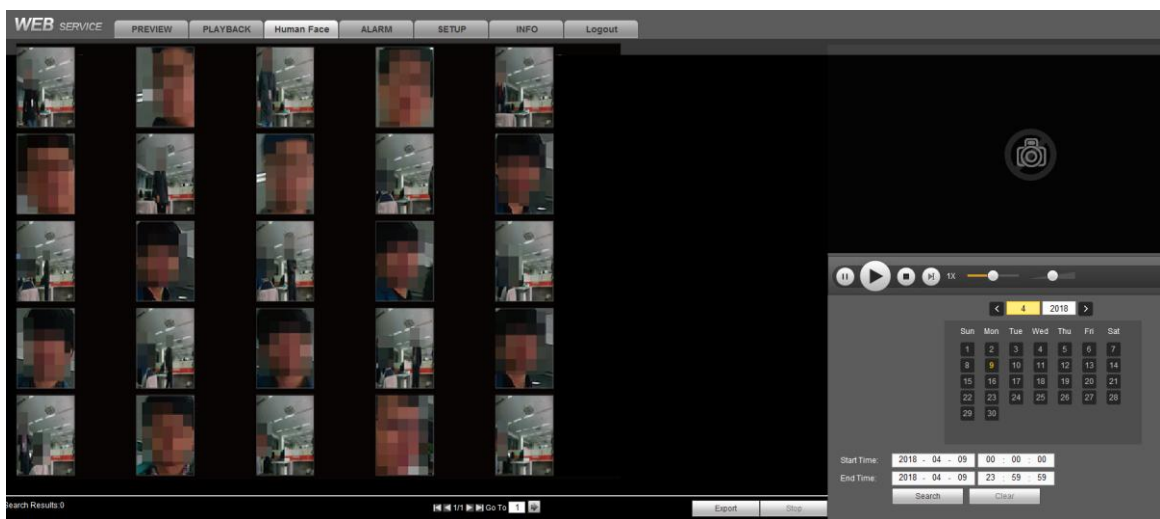

Step 3 (Optional) View the records corresponding to the face images.

 **NOTE**

Perform this step when you need to view the face record.







Select the face image and click  or double-click the face image, and the system starts to replay the corresponding record. Some operations are supported after the record playback is enabled. See Table 5-9.

Table 5-9 Playback operations

Icon	Description
	Click this icon to pause the playback.
	When the record is paused, click this icon to play record by frame.
	Click this icon to stop playback.
	Move the slider to adjust the rate. The higher the rate, the faster the speed.
	Adjust the playback volume.

Step 4 (Optional) Download face images or records.

 NOTE

Perform this step when you need to download face images or records.

- 1) Click **Export**.

The **Setup** interface is displayed. See Figure 5-22.

Figure 5-22 Setting

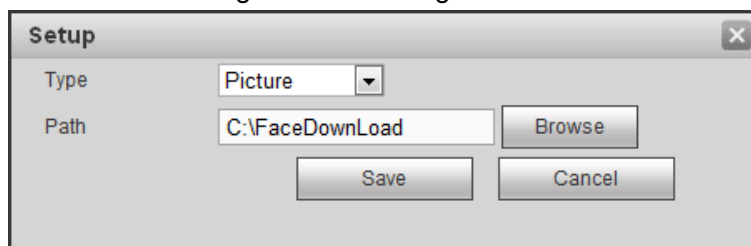

- 2) Select **Picture** or **Record** in the **Type** and select the storage path.
- 3) Click **Save**.

The system starts to download pictures or records.

 NOTE

During the picture and record download process, click **Stop** to end the download.

5.4 Subscribing Alarm Events

When the alarm event subscribed by the user is triggered, the system will record the alarm information in the window bar on the right.

 NOTE

Different devices might have different functions. See the actually displayed interfaces.

5.4.1 Understanding Alarm Types

Understand device alarm types and the preconditions of event occurrence. For details, see Table 5-10.

Table 5-10 Description of alarm types

Alarm Type	Note	Precondition
Motion detect	Export an alarm if any moving thing is detected in the record image.	Motion detect is enabled. For details, see "6.3.1.1 Motion Detect Settings."
External alarm	Export an alarm when alarm signal is detected on the alarm input port of the device.	Local alarm is enabled. For details, see "6.3.2 Alarm Settings."
Video occlusion	Export an alarm when the video is shielded.	Video occlusion detection is enabled. For details, see "6.3.1.2 Tampering Detection Settings."
Memory card fault	Export an alarm when the device hard disk is breakdown or abnormal.	Memory card fault detection is enabled. For details, see "6.3.3 Abnormality Handling Settings."

Alarm Type	Note	Precondition
Full memory card	Export an alarm when the remaining space of the device's hard disk is less than the set value.	The function of memory card insufficiency detection is enabled. For details, see "6.3.3 Abnormality Handling Settings."
Over temperature	Export an alarm when the temperature of the device is too high.	Over temperature detection is enabled. For details, see "6.3.3 Abnormality Handling Settings."

5.4.2 Alarm Subscription Settings

Enable alarm prompt and customize alarm prompt tone according to actual situation.

Step 1 Click the **ALARM** tab.

The **ALARM** interface is displayed. See Figure 5-23.

Figure 5-23 Alarm

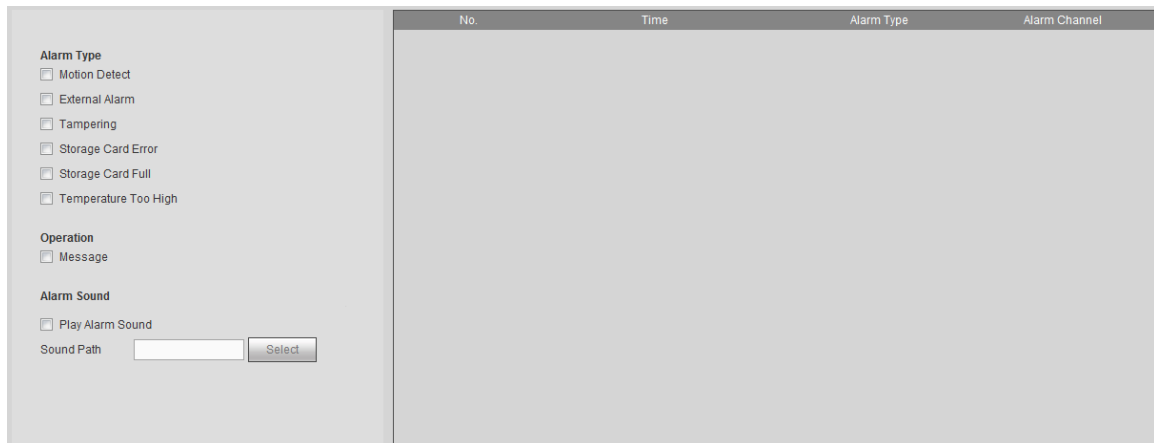

Step 2 Select the alarm type.

Step 3 Select **Message** check box. The alarm information is recorded and prompted according to the actual situation.

- When the subscribed alarm event is triggered and the system is not in the alarm interface, the icon  will appear on the alarm tab, and the system automatically records the alarm information. After clicking the alarm tab, the icon will disappear.
- When the subscribed alarm event is triggered and the system is in the alarm interface, the system will record the corresponding alarm information in the alarm list on the right side of the interface.

Step 4 Select **Play Alarm Sound** check box and select the sound path.

 **NOTE**

This is available for the Internet Explorer browser only.

When the subscribed alarm event is triggered, the system will play the selected sound file for the prompt of alarm event triggering.

6 System Settings

Set the system information, including camera, network parameters, event handling and memory card.

NOTE

After one channel is set in this section, click **Apply to**, and the settings of this channel can be applied to other channels. Click **Refresh**, the system shows the configuration data which is saved most recently. Click **Defaults** or **Restore to Factory Defaults**, the system configuration data is restored to factory defaults.

6.1 Network Parameter Settings

Set the network parameters of the device according to practical needs, including connection parameters, Wi-Fi parameters, 3G/4G parameters, automatic registration parameters and Bluetooth parameters.

6.1.1 Connection Parameter Settings

Set the connection ports and HTTPS function.

6.1.1.1 Connection Port Settings

Set the ceiling of the port number the device can be connected and the value of each port.

Step 1 Select **SETUP > NETWORK > CONNECTION > Connection Setting**.

The **Connection Setting** interface is displayed. See Figure 6-1.

Figure 6-1 Connection settings

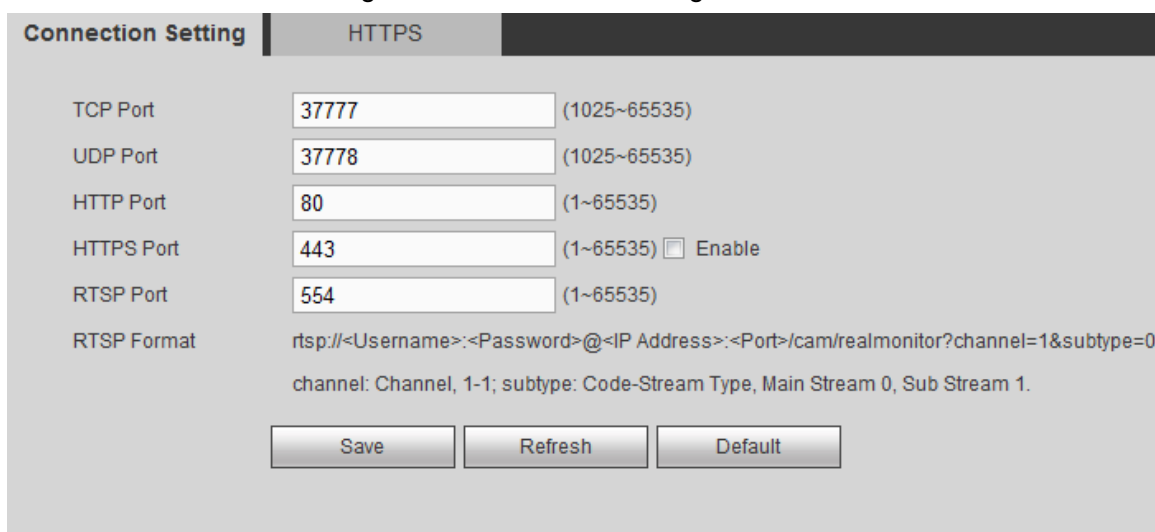

Connection Setting		HTTPS
TCP Port	<input type="text" value="37777"/>	(1025~65535)
UDP Port	<input type="text" value="37778"/>	(1025~65535)
HTTP Port	<input type="text" value="80"/>	(1~65535)
HTTPS Port	<input type="text" value="443"/>	(1~65535) <input type="checkbox"/> Enable
RTSP Port	<input type="text" value="554"/>	(1~65535)
RTSP Format	rtsp://<Username>:<Password>@<IP Address>:<Port>/cam/realmonitor?channel=1&subtype=0 channel: Channel, 1-1; subtype: Code-Stream Type, Main Stream 0, Sub Stream 1.	
<input type="button" value="Save"/> <input type="button" value="Refresh"/> <input type="button" value="Default"/>		

Step 2 Enter the value of each port. For detailed parameter description, see Table 6-1.



The change of parameter settings will take effect only after restart. Be careful to perform it.

Table 6-1 Description of port parameters

Parameter	Description
TCP Port	Provides TCP protocol communication services. Default is 37777.
UDP Port	Protocol port for user data packet. Can be set according to user's actual needs. Default is 37778.
HTTP Port	HTTP communication port. Can be set according to user's actual needs. Default is 80. If it is set to some other value, the modified port number shall be added after the address when logging in in the browser.
HTTPS Port	HTTPS communication port. Select Enable check box and set it according to user's actual needs. Default is 443.
RTSP Port	<ul style="list-style-type: none"> The default RTSP port number is 554. You may ignore it if using the default number. You can use the below formats to play real-time monitors with Apple Browser QuickTime or VLC. Blackberry also supports this function. Real-time monitoring stream URL format. When request real-time monitoring stream RTSP stream media service, the request channel number and stream type shall be indicated in URL. If any authentication information is needed, user name and password are also needed. When users access with Blackberry mobile phones, they need to set the encoding mode to H.264, set the resolution to CIF and close audio. <p>Notes for URL format: rtsp://<username>:<password>@<IP address>:<port>/cam/realmonitor?channel=1&subtype=0</p> <ul style="list-style-type: none"> User name: such as admin. Password: such as admin_123 IP address: such as 192.168.1.16. Port number: default is 554. May not fill in if using the default Channel: channel number. Start from 1. Like channel 2: channel=2. subtype: stream type. Main stream is 0 (i.e. subtype=0). Sub stream is 1 (i.e. subtype=1). <p>E.g. request for the sub stream of the channel. URL see below: rtsp://admin:admin_123@192.168.1.16:554/cam/realmonitor?channel=1&subtype=1</p> <p>If authentication is not needed, user name and password are not needed. The below format is fine: rtsp:// <IP address >:<port>/cam/realmonitor?channel=1&subtype=0</p>

Step 3 Click **Save**.

6.1.1.2 HTTPS Parameter Settings

Set the port number by creating a server certificate or downloading the root certificate, to enable PC normal login through HTTPS, which can guarantee the security of data communication and provide protection for user information and device safety with reliable and stable technical means.

Server certificate creation and root certificate download can be performed only when HTTPS

port is enabled. For detailed operations to enable HTTPS, see "6.1.1.1 Connection Port Settings."

Create Server Certificate

When use this function for the first time or the device IP address is changed, you need to create server certificate.

Step 1 Select **SETUP > NETWORK > CONNECTION > HTTPS**.

The **HTTPS** interface is displayed. See Figure 6-2.

Figure 6-2 HTTPS

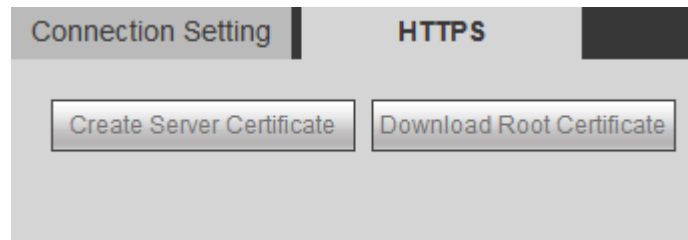

Step 2 Click **Create Server Certificate**.

The dialogue box of **Create Server Certificate** is displayed. See Figure 6-3.

Figure 6-3 Create server certificate

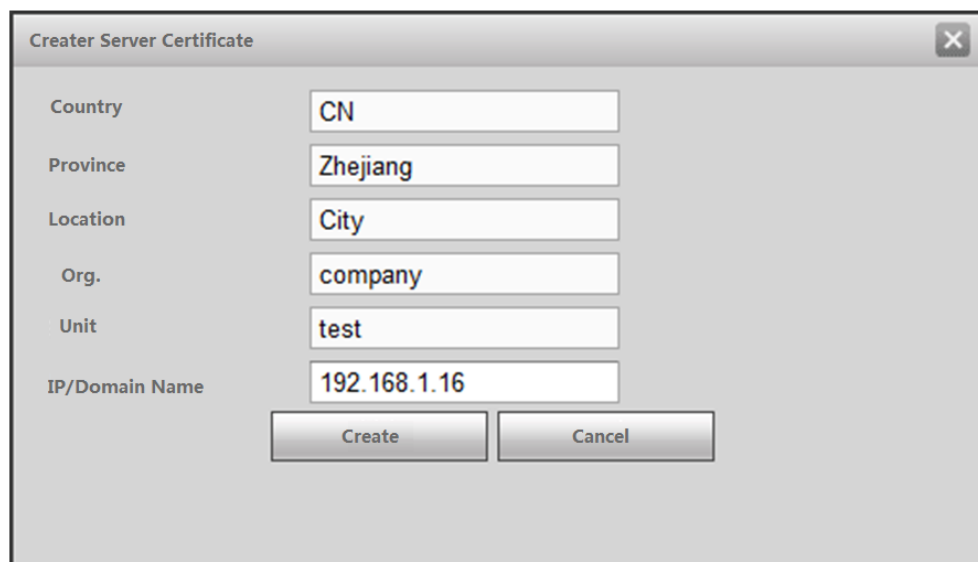
The image shows a dialog box titled 'Create Server Certificate'. It contains several text input fields: 'Country' (CN), 'Province' (Zhejiang), 'Location' (City), 'Org.' (company), 'Unit' (test), and 'IP/Domain Name' (192.168.1.16). At the bottom, there are two buttons: 'Create' and 'Cancel'.

Step 3 Enter the corresponding information, such as **Country, Province**.

 **NOTE**

The value of **IP/Domain Name** shall be the same as that of the device.

Step 4 Click **Create**.

Create Successfully pops up when it is done.

Downloading Root Certificate

If you use HTTPS for the first time after computer change, you need to download root certificate.

Step 1 Select **SETUP > NETWORK > CONNECTION > HTTPS**.

The **HTTPS** interface is displayed. See Figure 6-2.

Step 2 Click **Download Root Certificate**.

The **File Download-Security Warning** interface is displayed. See Figure 6-4.

Figure 6-4 File download



Step 3 Click **Open**.

The **Certificate** interface is displayed. See Figure 6-5.

Figure 6-5 Certificate

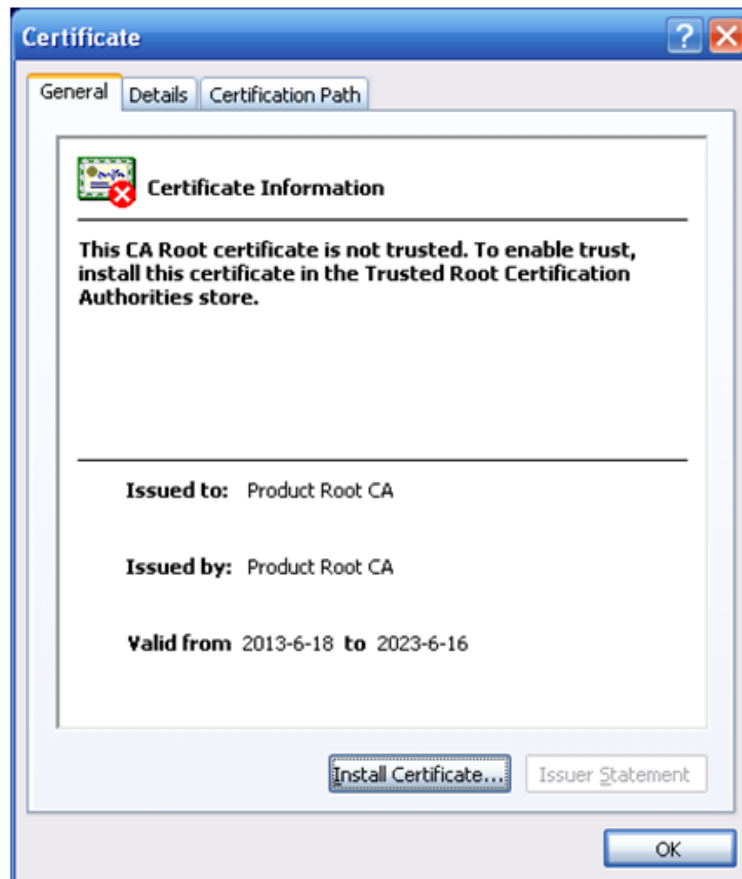

Step 4 Click **Install Certificate**.

The **Certificate Import Wizard** interface is displayed. See Figure 6-6.

Figure 6-6 Certificate import wizard



Step 5 Click **Next**.

The interface indicates you to select the certificate storage path. See Figure 6-7.

Figure 6-7 Certificate storage

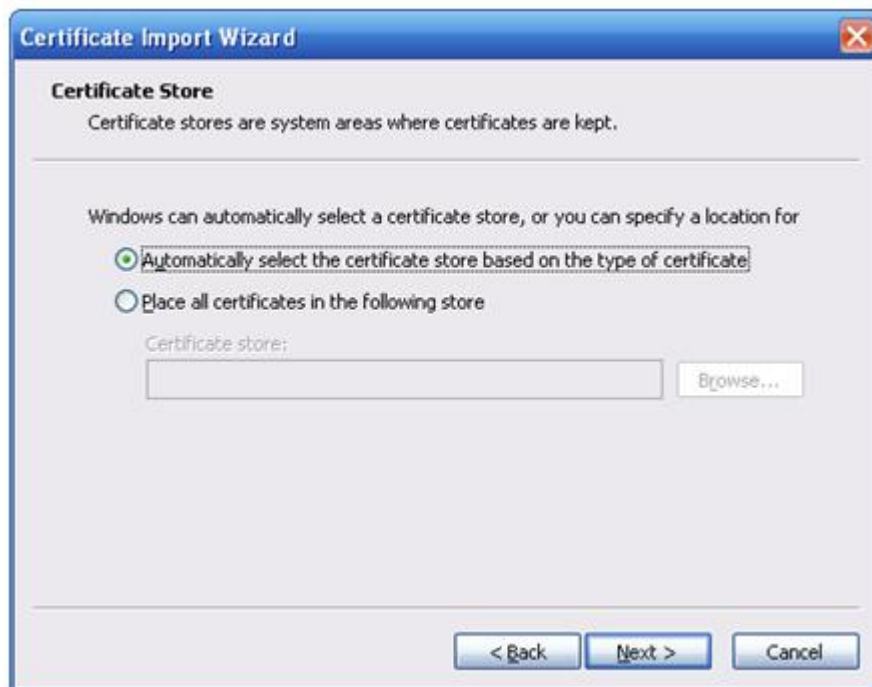

Step 6 Click **Next**.

The interface shows that certificate import is going on. See Figure 6-8.

Figure 6-8 Certificate import wizard is going on

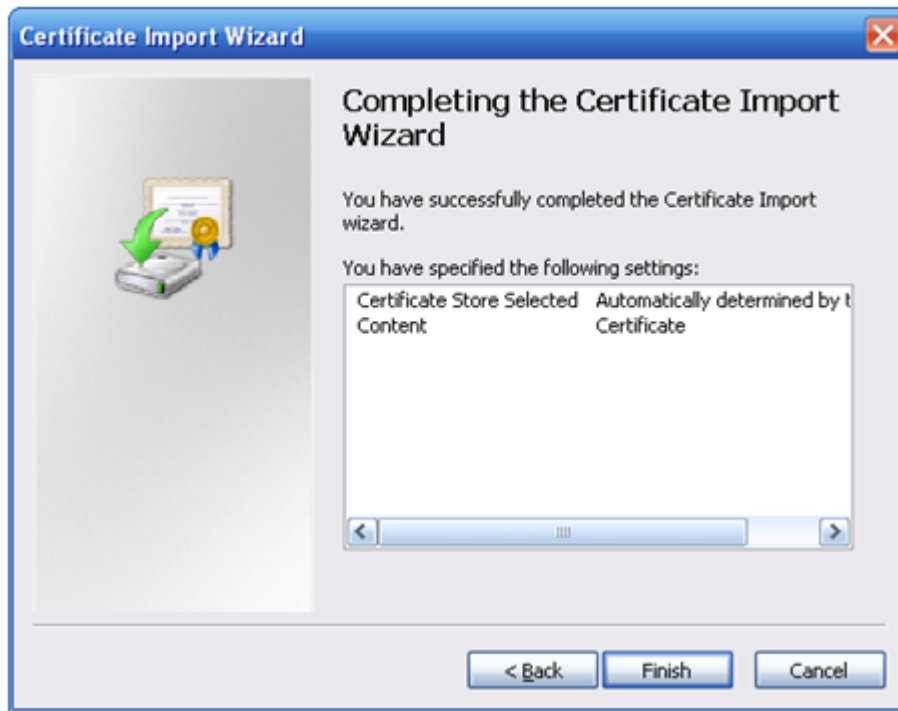

- Step 7** Click **Finish**.
The **Security Warning** interface is displayed.
- Step 8** Click **Yes**.
The certificate is downloaded successfully.

Viewing and Setting HTTPS Port Number

When the server certificate is created or certificate is downloaded, you need to set the ports.

- Step 1** Select **SETUP > NETWORK > CONNECTION > Connection Setting**.
The **Connection Setting** interface is displayed. See Figure 6-9.

Figure 6-9 Settings interface of HTTPS ports

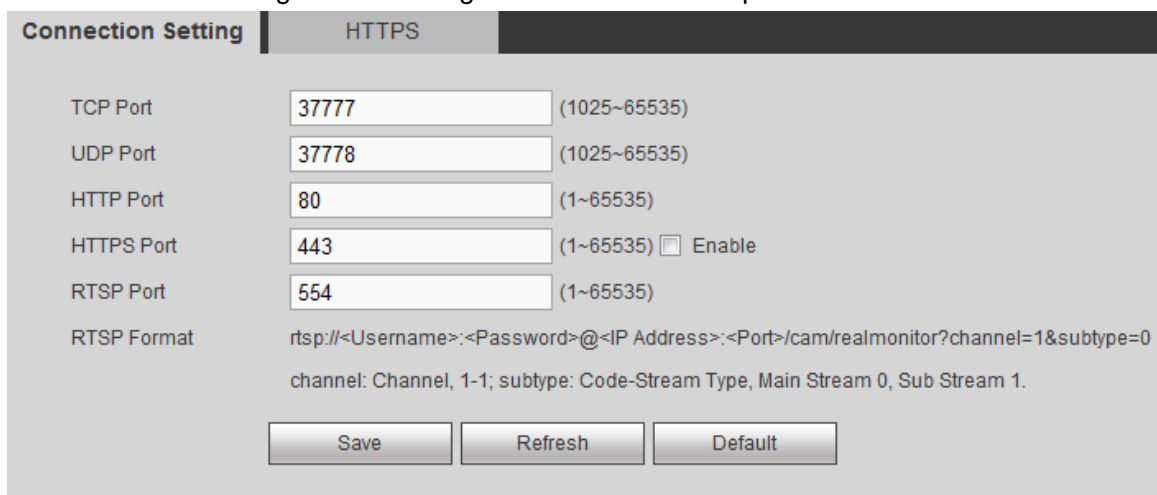

- Step 2** Enter the port number in the **HTTPS Port** box. The default value is **443**.
- Step 3** Click **Save**.

Using HTTPS for Login

Use HTTPS for login.

Enter <https://xx.xx.xx.xx:port> in the browser and the login interface is displayed.

 NOTE

- **xx.xx.xx.xx** corresponds to your device IP or domain name.
- **port** corresponds to your HTTPS port. **:port** can be cancelled if using the default port 443, and you can access directly with **https://xx.xx.xx.xx**.

6.1.2 Wi-Fi Parameter Settings

When the Wi-Fi working mode is off, Wi-Fi is closed. Wi-Fi network and Wi-Fi hotspot can be set according to practical needs.

6.1.2.1 Wi-Fi Network Settings

Access the device to network by setting the Wi-Fi parameters.

Step 1 Select **SETUP > NETWORK > Wi-Fi**.

The **WiFi** interface is displayed.

Step 2 Select **WiFi** in the **Working Mode Selection**.

The **WiFi** interface is displayed. See Figure 6-10.

Figure 6-10 Wi-Fi

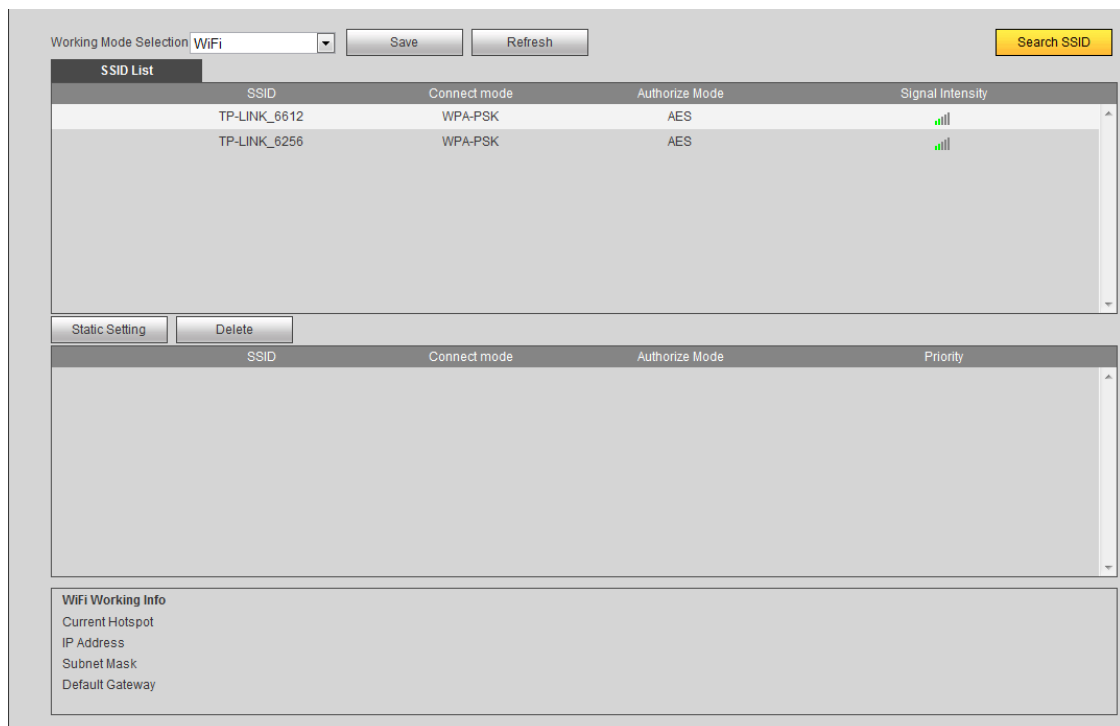

Step 3 Connect to Wi-Fi.

- Automatic search.
 - 1) Click **Search SSID**.
In the SSID list, all available Wi-Fi names and their security types, encryption modes and signal strength are displayed.
 - 2) Double-click the network, enter password and click **Save** to access network.
- Add Wi-Fi Manually
 - 1) Click **Static Setting**.

The **WiFi** interface is displayed. See Figure 6-11.

Figure 6-11 Wi-Fi configuration

The screenshot shows a 'WiFi' configuration window with the following fields and values:

- SSID: [Empty text box]
- Connection Status: No Connection
- Priority: 1 (dropdown menu)
- Verification: OPEN (dropdown menu)
- IP Address: 0 . 0 . 0 . 0
- Subnet Mask: 0 . 0 . 0 . 0
- Default Gateway: 0 . 0 . 0 . 0
- DHCP: (unchecked)

Buttons: Save, Cancel

- 2) Enter **SSID** and password. Select **Priority**, **Verification** and **Encryption**. Enter **IP address**, **Subnet Mask** and **Default Gateway**.

If **DHCP** check box is selected, the system will automatically get the Wi-Fi corresponding IP address, subnet mask and default gateway after accessing network successfully.

- 3) Click **Save**.

Step 4 Click **Save**.

Click **Refresh** to get the connection status.

After accessing network, you can view current hotspot, IP address, subnet mask and default gateway in Wi-Fi working information.

6.1.2.2 Wi-Fi Hotspot Settings

The device can be used as a hotspot for other terminals. The terminals connected to this hotspot can log in the device through the host IP 192.168.2.108. After logging in the device, it can preview video and operate the rotation of the speed dome.

Step 1 Select **SETUP > NETWORK > WiFi**.

The **WiFi** interface is displayed.

Step 2 Select **Ap** in the **Working Mode Selection**.

The hotspot setting interface is displayed. See Figure 6-12.

Figure 6-12 Hotspot settings

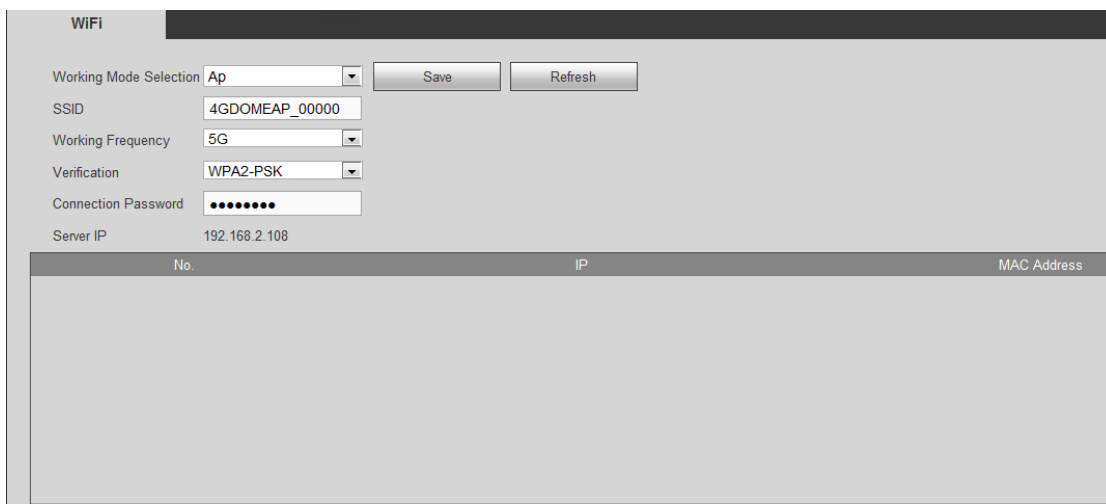

Step 3 Enter **SSID**. Select **Working Frequency** and **Verification**, and then enter **Connection Password**.

- Working frequency includes 2.4G and 5G and the default is 5G. You can select according to practical needs.
- The default connection password is 12345678.

Step 4 Click **Save**.

6.1.3 3G/4G Network Settings

After the SIM card is installed, the device can access network by dialing, to enable the platform and mobile terminals to receive alarm information, audios/records, pictures and device status.

6.1.3.1 Enabling 3G/4G Network

After enabling the network of SIM card, the corresponding SIM card can access network normally. The system has enabled the online function of SIM Card 1 by default. You can enable the online function of SIM Card 2 according to practical needs.

Step 1 Select **SETUP > NETWORK > 3G/4G > 3G Power On/Off**.

The **3G Power On/Off** interface is displayed. See Figure 6-13.

Figure 6-13 3G Power on/off settings

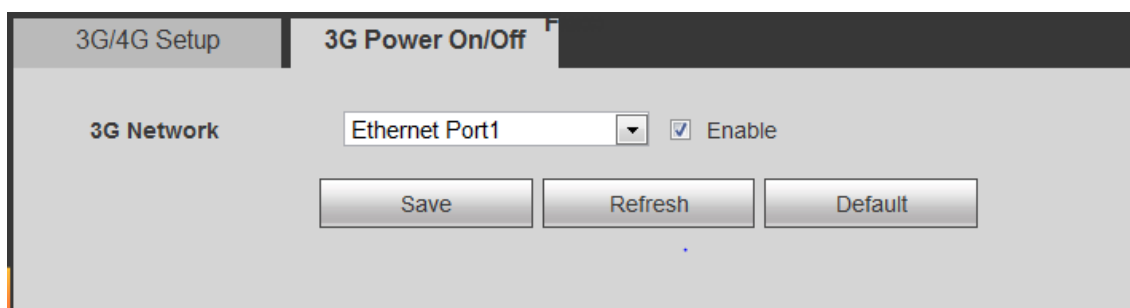

Step 2 Select **3G Network** and select the **Enable** check box to enable the SIM online function. Network Card 1 corresponds to SIM Card 1 and Network Card 2 corresponds to SIM Card 2.

Step 3 Click **Save**.

6.1.3.2 3G/4G Parameter Settings

- SIM card shall have been installed.
- You shall have obtained the dialing number, user name and password from the operator.

Step 1 Select **SETUP > NETWORK > 3G/4G > 3G/4G Setup**.

The **3G/4G Setup** interface is displayed. See Figure 6-14.

Figure 6-14 3G/4G settings

Step 2 Select the **3G Network** and select the **Enable** check box to enable 3G/4G network. The online function of Network Card 1 is enabled by default.

Network Card 1 corresponds to SIM Card 1 and Network Card 2 corresponds to SIM Card 2.

Step 3 Set the parameters. For details, see Table 6-2.

Table 6-2 Description of 3G/4G parameter settings

Parameter	Description
NetAccess	When the device is connected to the private network, select the NetAccess check box and select the APN and AUTH . When the AUTH is PAP and CHAP , the system can access the private network automatically when the user name and password are entered.
3G Type	Display network type after enabling, which is to distinguish the 3G/4G modules from different suppliers, such as FDD-LTE.
APN	When enabled, display the supplier access point. When select Customized for APN , APN can be set manually.
AUTH	Authentication mode, including PAP, CHAP and NO_AUTH protocols. The system can identify it automatically after enabling.
Dial No.	Enter the dialing number provided by the operator.
User name	When the AUTH is PAP and CHAP , this parameter needs to be set.
Password	After enabling, the system can identify user name and password automatically.
Wireless Signal	Click Search to search Wi-Fi signal. After getting the wireless network signal, the signal type and strength can be viewed.

Step 4 Click **Save**.

After the dial-up is successful, module status, SIM status, PPP dial status, working mode, IMSI, IP address, subnet mask, default gateway, module type and ICCID information will be displayed on the 3G status interface.

6.1.4 Automatic Registration Settings

After automatic registration, when the device is connected to the external network, it will actively report the current location to the platform, so that the client software can access the device through the server for preview and monitoring.

Step 1 Select **SETUP > NETWORK > REGISTER**.

The **REGISTER** interface is displayed. See Figure 6-15.

Figure 6-15 Automatic registration

The screenshot shows the 'REGISTER' interface with the following settings:

- Enable
- Server IP: 0.0.0.0
- Port: 9500 (0~65535)
- Sub-device ID: 00000000000000000000

Buttons: Save, Refresh, Default

Step 2 Select **Enable** check box to enable automatic registration. This function is enabled by default.

Step 3 Set the parameters. For details, see Table 6-3.

Table 6-3 Automatic registration parameters

Parameter	Description
Server IP	Enter the server IP or server domain name which you need to register to.
Port	The port number used by the server for active registration.
Sub-device ID	The ID shall be unique. When different devices are registered to the same server, the sub-device IDs shall not be the same.

Step 4 Click **Save**.

6.1.5 Bluetooth Settings

Connect Bluetooth headsets to do voice intercom with the PC logged in the Web.

Step 1 Select **SETUP > NETWORK > Bluetooth**.

The **Bluetooth** interface is displayed.

Step 2 Select **Enable** check box to enable the Bluetooth.

The system automatically searches for the Bluetooth devices near the device and displays them in the Bluetooth list. See Figure 6-16.

NOTE

- Click **Refresh List** to enable the system to search for Bluetooth near the device.
- In the Bluetooth list, you can see the name of the Bluetooth device, MAC address, address type and signal intensity.

Figure 6-16 Bluetooth device list

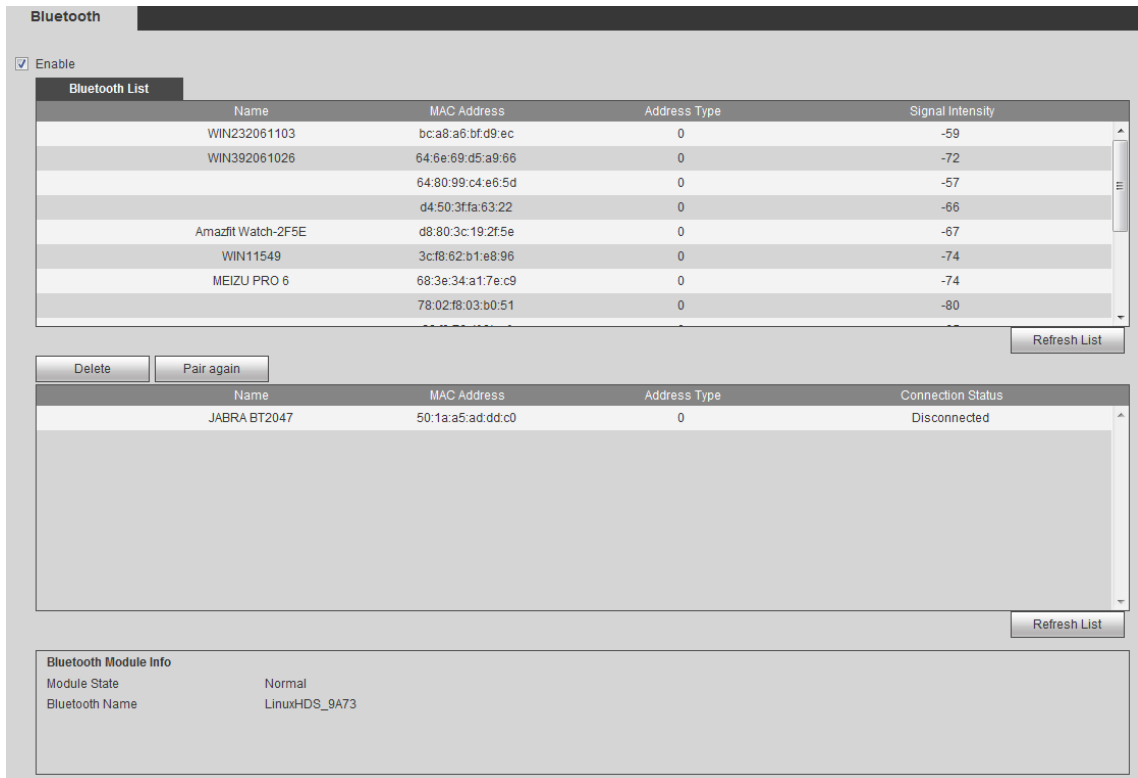

- Step 3** Double-click the Bluetooth you need to connect.
The **Bluetooth** interface is displayed. See Figure 6-17.
Figure 6-17 Bluetooth settings

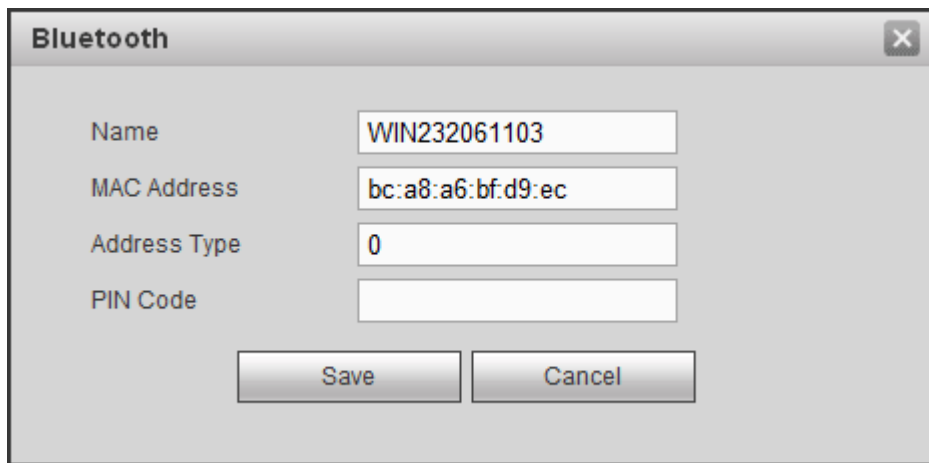

- Step 4** Enter **PIN Code**.
Usually the PIN code of Bluetooth device is 0000 or 1234. Different Bluetooth devices might have different PIN codes. For details, see the user's manual of Bluetooth device.
- Step 5** Click **Save**.
After the Bluetooth device is connected successfully, you can view the module state and Bluetooth name in **Bluetooth Module Info**.

 **NOTE**

- Click **Refresh List** to update the paired Bluetooth device list.
- Click **Pair again** to connect the Bluetooth device which used to be paired successfully.
- Click **Delete** to delete the Bluetooth device.

6.2 Camera Parameter Settings

Set the image property, encoding parameter and corresponding channel name of the camera.

6.2.1 Encoding Parameter Settings

Set the encoding parameters, including setting record bit stream, picture bit stream, record overlap and storage path.

6.2.1.1 Record Bit Stream Settings

Set the stream parameters for the main stream and sub stream.

Step 1 Select **SETUP > CAMERA > ENCODE > Encode**.

The **Encode** interface is displayed. See Figure 6-18.

Figure 6-18 Record stream

The screenshot shows the 'Encode' configuration window with four tabs: 'Encode', 'Snapshot', 'Overlay', and 'Path'. The 'Encode' tab is active. At the top, there is a 'Channel' dropdown menu set to '1'. Below this, the interface is divided into two columns: 'Main Stream' and 'Sub Stream'. Each column contains several settings: 'Code-Stream Type' (Regular), 'Compression' (H.265), 'Resolution' (1920*1080(1080P) for Main, 704*576(D1) for Sub), 'Frame Rate(FPS)' (25), 'Bit Rate Type' (CBR), 'Bit Rate' (2048 Kb/S for Main, 1280 Kb/S for Sub), and 'Reference Bit Rate' (768-4608Kb/S for Main, 236-1280Kb/S for Sub). There are also checkboxes for 'Audio Enable' (unchecked) and 'Watermark Enable' (checked). The 'Audio Format' is set to 'G711a' for both streams. The 'Watermark String' is set to 'DigitalCCTV'. At the bottom, there are 'Save' and 'Refresh' buttons.

Step 2 Select channel number.

Step 3 Set the parameters. For details, see Table 6-4.

Table 6-4 Description of record stream parameters

Parameter	Description
Code-Stream Type	Three different record types can be selected to set the corresponding encoding parameters: Normal, motion detect and alarm.
Compression	Record encoding mode, including H.264 and H.265.
Resolution	Record resolution. The higher the resolution, the better the picture quality.
Frame Rate (FPS)	The frame number displayed by the record per second. The higher the frame rate, the more realistic and smooth the picture.

Parameter	Description
Bit Rate Type	<p>Bit stream control mode.</p> <ul style="list-style-type: none"> Limited stream: The bit stream changes less. It changes near the set stream value. Variable stream: The stream changes with the environment. <p> NOTE</p> <p>It is suggested to select the limited stream when the monitoring scene changes little, and select the variable stream when the scene changes greatly.</p>
Bit Rate	<p>Set the value for the main stream and sub stream.</p> <ul style="list-style-type: none"> When you select CBR in the Bit Rate Type list, select bit rate according to the reference bite rate. The stream changes near the set value. When you select VBR in the Bit Rate Type list, select bit rate according to the reference bite rate. The stream changes with the monitoring scene, but the maximum stream changes near the set value. When you select Customized in the Bit Rate Type list, you can set the bit rate manually.
Picture Quality	<p>This parameter can be set when selecting VBR in the Bit Rate Type list.</p> <p>Level of the record picture quality.</p>
Reference Bit Rate	<p>The system recommends the optimal stream range according to the resolution and frame rate configured by the user.</p>
Audio Enable	<p>After the audio function is turned on, the video file is a composite stream of audio and video.</p>
Audio Format	<p>Select the audio encoding format.</p>
Watermark Enable	<p>Select Watermark Enable check box. View if the video is tampered with by checking the watermark characters.</p>
Watermark String	<p>Set the characters of watermark checking. The default is DigitalCCTV. The watermark characters can only be composed of number, letter, underline and strike. The longest is 127 characters.</p>

Step 4 Click **Save**.

6.2.1.2 Picture Stream Settings

Set the picture stream parameters, including snapshot type, picture size, picture quality and snapshot interval.

Step 1 Select **SETUP > CAMERA > ENCODE > Snapshot**.

The **Snapshot** interface is displayed. See Figure 6-19.

Figure 6-19 Picture stream

Step 2 Select the channel number.

Step 3 Configure the parameters. For details, see Table 6-5.

Table 6-5 Description of picture stream parameters

Parameter	Description
Mode	Including timing snapshot and triggering snapshot. <ul style="list-style-type: none"> Timing snapshot means picture capturing within the range set by the time schedule. Triggering snapshot means picture capturing when alarms of video detection and abnormality are triggered.
Image Size	The resolution is the same as the main stream.
Quality	Set the snapped picture quality. It includes 1~6 levels. The higher the level, the clearer the picture.
Interval	Set the snapshot frequency. Select Customized . You can set the snapshot frequency manually, and it can be up to 3,600 pictures / second.

Step 4 Click **Save**.

6.2.1.3 Video Overlay Settings

Set the header information of the overlapped video images. The channel header, time header and battery power stack are enabled by default.

Step 1 Select **SETUP > CAMERA > ENCODE > Video Overlay**.

The **Overlay** interface is displayed. See Figure 6-20.

Figure 6-20 Video overlap

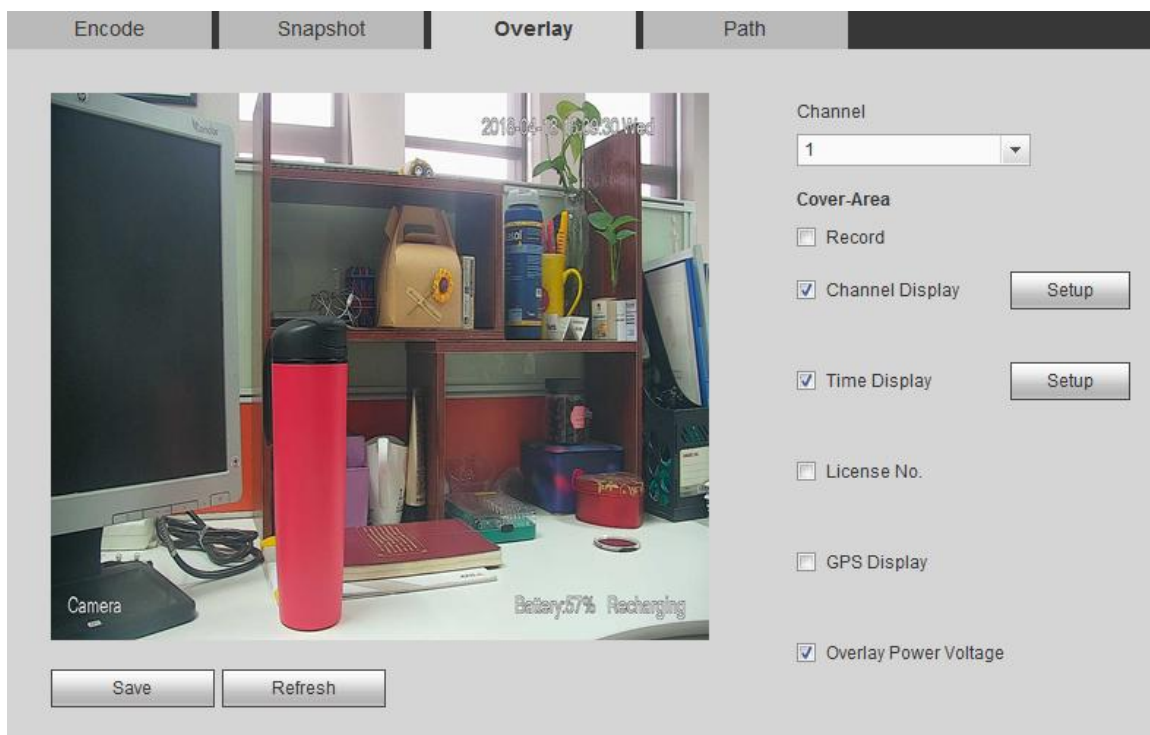

Step 2 Select channel number.

Step 3 Configure the parameters. For details, see Table 6-6.

Table 6-6 Description of video overlap parameters

Parameter	Note
Cover-Area	Select Record check box, the Setup button is displayed. Click Setup on the right side, select a region on the video screen by holding down the left button of the mouse, and the overlapping region can be added. At most 4 regions can be set.
Channel Display	Select Channel Display check box, the Setup button is displayed. Click Setup on the right side, and then drag the channel header to the appropriate position.
Time Display	Select Time Display check box, the Setup button is displayed. Click Setup on the right side, and then drag the time header to the appropriate position.
License No.	Select License No. check box, the Setup button is displayed. Click Setup on the right side, and then drag the license No. to the appropriate position.
GPS Display	Select GPS Display check box, the Setup button is displayed. Click Setup on the right side, and then drag the GPS header to the appropriate position.
Overlay Power Voltage	Select Overlay Power Voltage check box and the battery power information is displayed on the lower right corner of the video screen.

Step 4 Click **Save**.

6.2.1.4 Storage Path Settings



Set the storage path of local snapped pictures and local records in PC.

Step 1 Select **SETUP > CAMERA > ENCODE > Path**.

The **Path** interface is displayed. See Figure 6-21.

Figure 6-21 Storage path

Encode	Snapshot	Overlay	Path
	Snapshot Path	C:\PictureDownload\	Browse
	Record Path	C:\RecordDownload\	Browse
	Save		Default

Step 2 Click **Browse** to set the storage path for local snapped pictures and local records. The pictures and records got through local snapping  and local recording  in the preview interface are saved in these two paths. The default paths are C:\PictureDownload and C:\RecordDownload.

Step 3 Click **Save**.

6.2.2 Channel Name Settings

Set the channel name of the device.

Step 1 Select **SETUP > CAMERA > CAM NAME > Channel Name**.

The **Channel Name** interface is displayed. See Figure 6-22.

Figure 6-22 Channel name

Channel Name			
Channel 1	Camera		
Save		Refresh	Default

Step 2 Set the channel name.

Step 3 Click **Save**.

6.2.3 Viewing Camera Information

Select **SETUP > CAMERA > REMOTE**. The **Remote** interface is displayed. See Figure 6-23.

Click  to log in the Web interface of the camera. Both the default user name and password are admin. For detailed camera operations, see the corresponding user's manual.

Figure 6-23 Remote device

Channel	Modify	Delete	Status	IP Address	Port	Device Name	Remote Channel	Manufacturer	Channel Name	Go to WEB	Types
1				10.1.1.65	37777	2M04BE0YAK00016	1	Private			DH-SD-8A1230UA-HNI-MH

Refresh

6.3 Alarm Event Settings

Set the alarm events, including video detection, car plate recognition, alarm, abnormality handling and alarm output.

6.3.1 Video Detection Settings

Video detection includes motion detect and video occlusion detection, to detect the abnormality of video screen.

6.3.1.1 Motion Detect Settings

When target movement reaching the preset sensitivity is detected, the system generates alarm and links the set action.

Step 1 Select **SETUP > EVENT > DETECT > Motion Detect**.

The **Motion Detect** interface is displayed. See Figure 6-24.

Figure 6-24 Motion detect

Motion Detect | Tampering

Enable 1

Anti-dither 5 sec. (1-600) Sensitivity 3

Region Setup Delay Motion

Record Channel

Delay 10 sec. (10-300)

Alarm Out 1

Latch 10 sec. (1~300)

Snapshot

Log

Save Refresh

Step 2 Select the **Enable** check box.

Step 3 Set the region for motion detect.

1) Click **Setup** on the right side of **Region**.

The **Setup** interface is displayed. See Figure 6-25.

Figure 6-25 Region setting

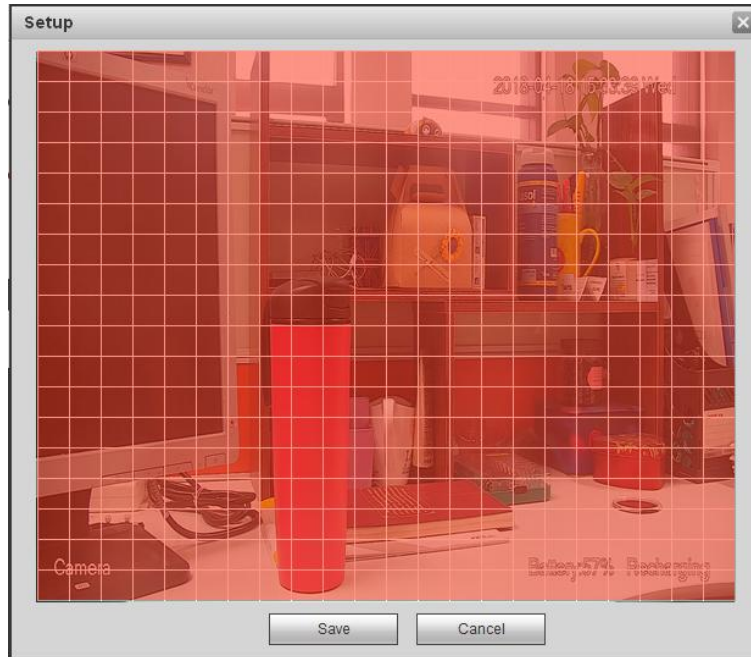



2) Set the effective region for motion detect as needed.

3) Click **Save** to complete the region setting.

Step 4 Configure the parameters. For details, see Table 6-7.

Table 6-7 Description of motion detect parameters

Parameter	Description
Anti-dither	Record only one alarm event during the set anti-dither period.
Sensitivity	The higher the sensitivity, the easier to produce motion detection.
Delay Motion	Select this check box and the system delays the performance of motion detect.
Record Channel	Select this check box and the system automatically starts recording when an alarm occurs.  NOTE The system shall satisfy the below two conditions before it starts to taking records when an alarm occurs: <ul style="list-style-type: none"> • Motion detect record is enabled. For details, see "4.6 Record Plan Settings." • Automatic record is set. For details, see "4.5 Record Control Settings."
Delay	The alarm record extends for a period after the alarm stops.
Alarm Out	Connect alarm device (like light and siren) on the alarm out port. Select this check box, set the alarm out device, and then enable the alarm out port linkage. When an alarm occurs, the system can link to the corresponding alarm out device.
Latch	The alarm extends for a period after the end of the alarm event.

Parameter	Description
Snapshot	Select this check box and the corresponding channel automatically snaps images of the alarm event when an alarm occurs.  NOTE You need to enable motion detect snapshot before enabling this function. For details, see "6.2.1.2 Picture Stream Settings."
Log	Select this check box. The system records the alarm information in the system logs when an alarm occurs.

Step 5 Click **Save**.

6.3.1.2 Tampering Detection Settings

When the lens is obstructed by someone maliciously, or the video output is a single color screen due to light and other reasons, the system generates alarm and performs the action linkage.

Step 1 Select **SETUP > EVENT > DETECT > Tampering**.

The **Tampering** interface is displayed. See Figure 6-26.

Figure 6-26 Video tampering

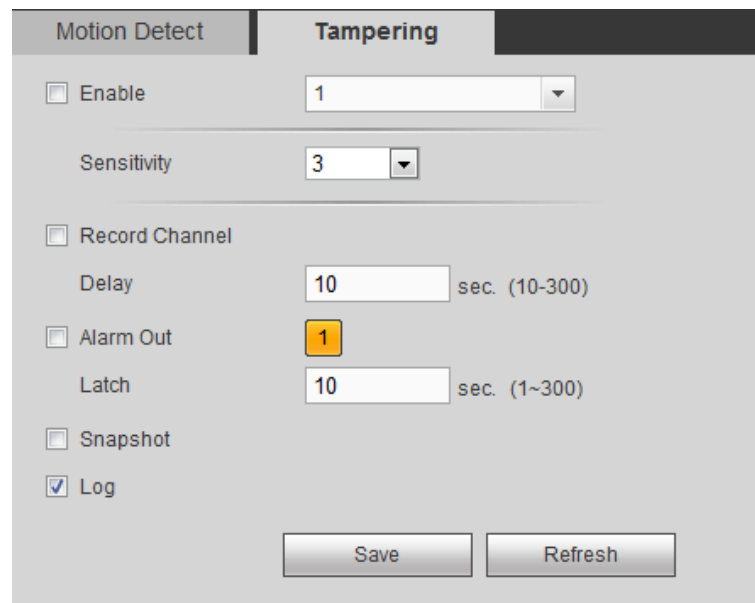

Step 2 Select the **Enable** check box.

Step 3 Configure the parameters. For details, see Table 6-7.

Step 4 Click **Save**.

6.3.2 Alarm Settings

Select the alarm input type according to the alarm source and set the alarm output type.

Step 1 Select **SETUP > EVENT > ALARM**.

The **Local Alarm** interface is displayed. See Figure 6-27.

Figure 6-27 Alarm settings

The screenshot shows the 'Local Alarm' configuration window. At the top, there is a title bar 'Local Alarm'. Below it, there are several settings:

- Enable: A dropdown menu is set to '1'.
- Alarm Name: A text field containing 'Alarm 1'.
- Overlay:
- Anti-dither: A text field with '2' and 'sec. (1-600)'.
- Type: A dropdown menu set to 'Normal Close'.
- Trigger: A dropdown menu set to 'High Level'.
- Record Channel: A checked checkbox.
- Delay: A text field with '10' and 'sec. (10-300)'.
- Alarm Out: A dropdown menu set to '1'.
- Latch: A text field with '10' and 'sec. (1-300)'.
- Snapshot: An unchecked checkbox.
- Log: A checked checkbox.

 At the bottom, there are three buttons: 'Save', 'Refresh', and 'Default'.

Step 2 Select the **Enable** check box to enable the local alarm function.

Step 3 Set the parameters. For details, see Table 6-8.

Table 6-8 Description of alarm parameters

Parameter	Description
Alarm Name	Enter the user-defined overlapped alarm name.
Overlay	Select this check box and the alarm name will be displayed in the preview video.
Anti-dither	Record only one alarm event during the set anti-dither period.
Type	The type of alarm device, including normal open and normal close. <ul style="list-style-type: none"> Normal open means that the alarm signal is normally broken and an alarm will be generated when the signal is closed. Normal close means that the alarm signal is normally closed and an alarm will be generated when the signal is broken.
Trigger	When the alarm is 12V/24V voltage signal, select High Level in the Trigger list. When the alarm is ground signal, select Low Level in the Trigger list.
Record Channel	Select this check box and the system starts alarm recording automatically. NOTE The system shall satisfy the below two conditions before it starts to taking records when an alarm occurs: <ul style="list-style-type: none"> Motion detect record is enabled. For details, see "4.6 Record Plan Settings." Automatic record is set. For details, see "4.5 Record Control Settings."
Delay	The alarm record extends for a period after the alarm stops.
Alarm Out	Connect alarm device (like light and siren) on the alarm out port. Select this check box, set the alarm out device, and then enable the alarm out port linkage. When an alarm occurs, the system can link to the corresponding alarm out device.
Latch	The alarm extends for a period after the end of the alarm event.

Parameter	Description
Snapshot	Select this check box and the corresponding channel automatically snaps images of the alarm event when an alarm occurs.  NOTE You need to enable motion detect snapshot before enabling this function. For details, see "6.2.1.2 Picture Stream Settings."
Log	Select this check box. The system records the alarm information in the system logs when an alarm occurs.

Step 4 Click **Save**.

6.3.3 Abnormality Handling Settings

Set the handling methods when the device is abnormal.

Step 1 Select **SETUP > EVENT > ABNORMAL**.

The following interface is displayed. See Figure 6-26.

Figure 6-28 Abnormality handling

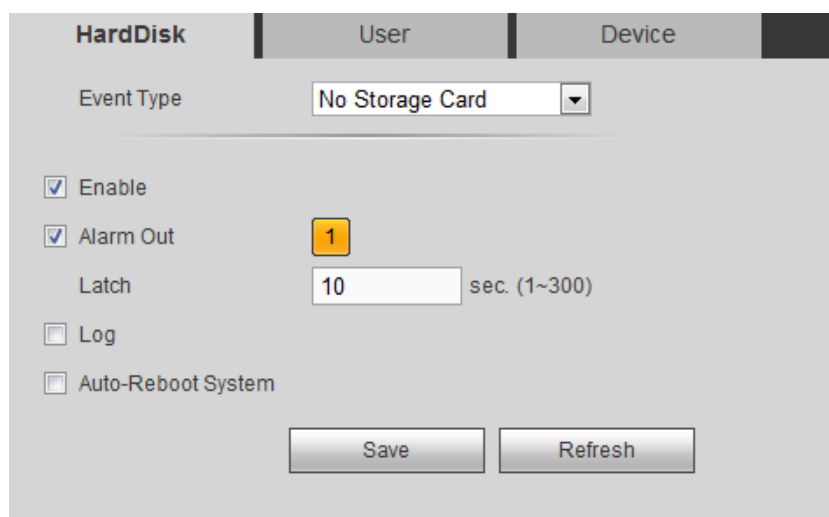

Step 2 Select **Enable** check box.

Step 3 Set the parameters. For details, see Table 6-9.

Table 6-9 Description of abnormality handling parameters

Parameter	Description
Event Type	Click the corresponding tab to set the different types of abnormal events. <ul style="list-style-type: none"> Memory Card: Set the handling modes of memory card abnormalities, including no card, card error and lack of space. User: Set the handling mode of user illegal login. Device: Set the handling mode of device over temperature.
Free Space	When the event type is storage card no space, you need to set this parameter. Set the minimum percentage of free space in the memory card. When the available space is less than the minimum value, the system generates an alarm.
Attempt(s)	When the event type is illegal login, you need to set this parameter. Set the maximum times of fault password entering. When the times of fault password entering exceeds this value, the account will be locked.

Parameter	Description
Lock Time	When the event type is illegal login, you need to set this parameter. Set the locked time period of the account when the fault password entering times exceeds the set value.
Max Temperature	When the event type is temperature too high, you need to set this parameter. Set the ceiling of device temperature. The system generates an alarm when the temperature is higher than the set value.
Alarm Out	Connect alarm device (like light and siren) on the alarm out port. Select this check box, set the alarm out device, and then enable the alarm out port linkage. When an alarm occurs, the system can link to the corresponding alarm out device.
Latch	The alarm extends for a period after the end of the alarm event.
Log	Select this check box. The system records the alarm information in the system logs when an alarm occurs.
Auto-Reboot System	Select this check box and the system automatically reboots three minutes after the alarm occurs.

Step 4 Click **Save**.

6.3.4 Alarm Output Settings

Set the alarm output mode.

Step 1 Select **SETUP > EVENT > ALARM OUT**.

The **Alarm Out** interface is displayed. See Figure 6-29.

Figure 6-29 Alarm output

The screenshot shows the 'Alarm Out' configuration page. The 'Alarm Type' is set to '1'. Under the 'Alarm Mode' section, there are four radio buttons: 'Auto', 'Manual', 'Stop', and 'Status'. The 'Stop' radio button is selected. At the bottom of the page, there are two buttons: 'Save' and 'Refresh'.

Step 2 Select the alarm mode of the channel:

- **Manual:** After setting the alarm output linkage, no matter alarm occurs in the channel or not, the corresponding output port exports alarm.
- **Auto:** After setting the alarm output linkage, when an alarm occurs in the channel, the corresponding output port exports the alarm.
- **Stop:** After setting the alarm output linkage, when an alarm occurs in the channel, the corresponding output port does not export the alarm.

Step 3 Click **Save**.

You can view the status of the alarm output port in **Status**. Alarm output available. Alarm output unavailable.

6.4 Storage Device Management

Manage storage devices and view storage information.

6.4.1 Memory Card Management

Set the read-write property of the memory card and view the capacity of the hard disk.

Select **SETUP > STORAGE > STORAGE CARD MANAGER**. The **Storage** interface is displayed. See Figure 6-30.

You can select read-write disk or read-only disk in the list of **Storage Card Operation**.

- Read-write disk: The system can read the data in the memory card and write data into the card as well.
- Read-only disk: The system can only read the data in the memory card.

When select the memory card and click **Format**, all the data in the card will be cleared and the device will reboot automatically. Be careful to perform it.

Figure 6-30 Storage device

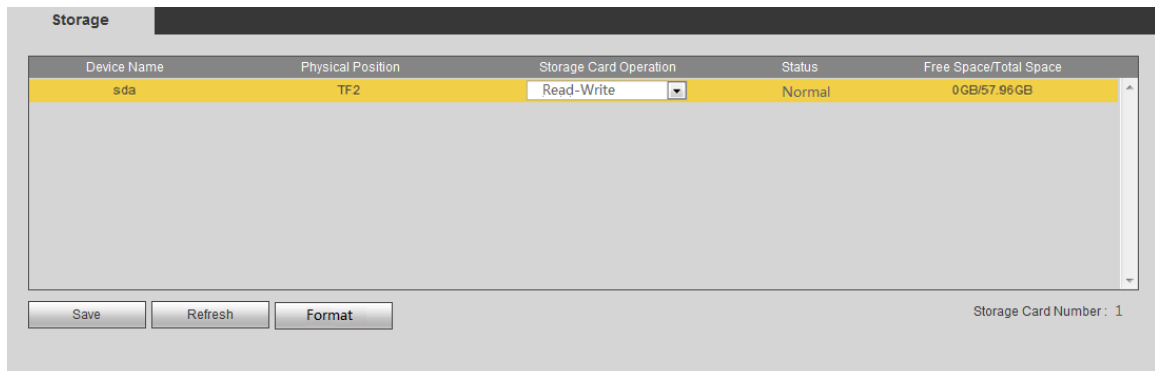

6.4.2 Viewing Memory Card Information

View the HDD information, record time period and Smart status.

Select **INFO > Storage Card**. The **Storage Card** interface is displayed. See Figure 6-31.

Select the memory card, click **Storage Card Time**, and then you can view the record information in the memory card.

Figure 6-31 Storage card information

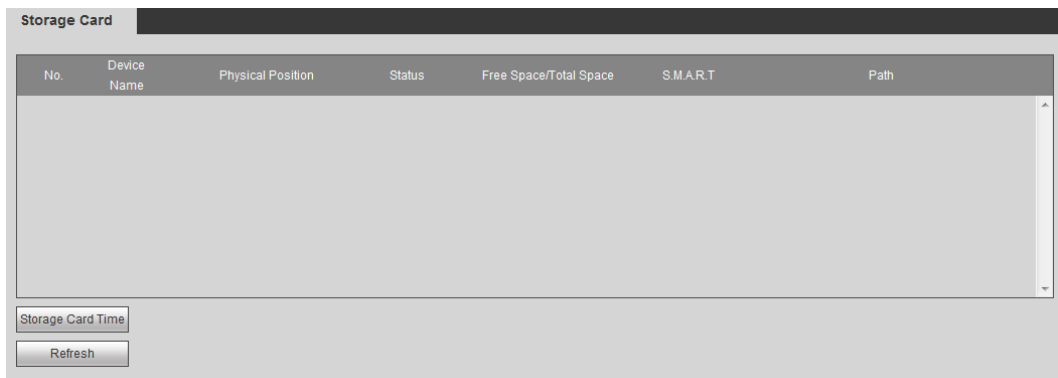

6.5 System Information Settings

Set the system information, including video mirroring and user account management.

6.5.1 Video Mirroring Settings

Images of the channel are flipped.

Step 1 Select **SETUP > SYSTEM > DISPLAY > Video Mirror**.

The **Video Mirror** interface is displayed. See Figure 6-32.

Figure 6-32 Video mirroring

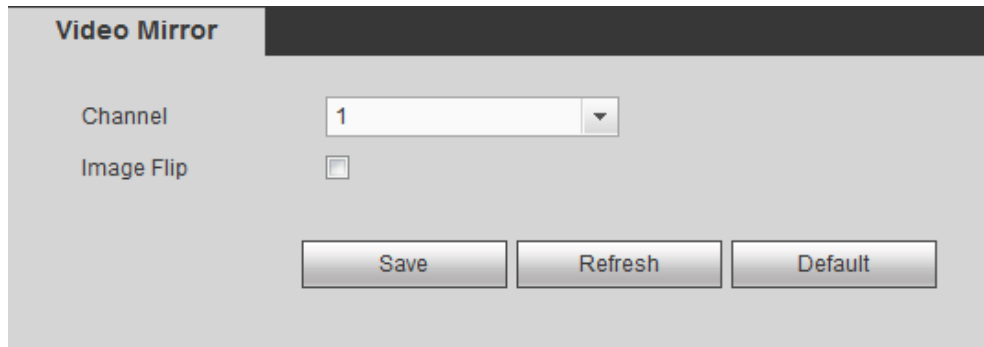

Step 2 Select **Image Flip** check box.

Step 3 Click **Save**.

6.5.2 User Account Management

Manage the user, user group and security question.

Default User and Authority

Admin is the default user account on factory delivery.

- Admin is a high authority account by default on factory delivery.
- To facilitate user management, it is recommended to set the authorities of general users lower than that of the senior users.

User Group and User Description

User management adopts two levels of user groups and users. Each user group name and user name is unique and cannot be repeated.

- Users and user groups can be respectively set to the largest number of 64 and 20.
- User and admin groups are default on factory delivery and cannot be deleted.
- User authority can be modified within the group authority, but you cannot appoint admin account at will.
- Each user must belong to and only belong to one group. When select a group for the user, the user authority can only be a subset of the set of group authorities and cannot go beyond the group authority properties.
- User name and group name are strings of 1-31 bytes, which consists of letter(s),

number(s), underline(s) and connector(s).

6.5.2.1 User Management

Manage user information, including adding, deleting and modifying users, adding group members and setting user authority control.

Adding users

Step 1 Select **SETUP > SYSTEM > ACCOUNT > User**.
The **User** interface is displayed. See Figure 6-33.

Figure 6-33 User

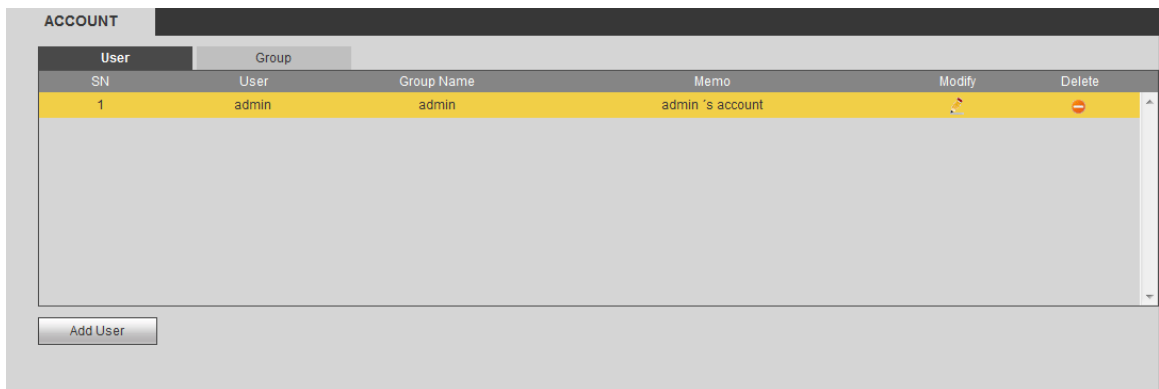

Step 2 Click **Add User**.
The **Adding User** interface is displayed. See Figure 6-34.

Figure 6-34 Adding user

Add User

User:

Password: Weak Moderate Strong

Confirm Password:

Group:

Memo:

Authority

System | Playback | Monitor

- All
- ACCOUNT
- SYSTEM INFO
- EVENT
- Vehicle
- SYSTEM
- MANUAL CONTROL
- NETWORK
- DEFAULT&UPGRADE
- BACKUP
- CAMERA
- PTZ
- STORAGE
- Shutdown

Save Cancel



Step 3 Set the parameters. For details, see Table 6-10.

Table 6-10 Description of adding user parameters

Parameter	Description
User	Enter the user name, password and confirm the password.
Password	
Confirm Password	
Memo	Enter the note information.
Group	Select the group that the user belongs to.
User MAC	Enter the MAC address authorized to log in this user account.
Authority	<p>User authorities can be modified within the group authorities.</p> <p> NOTE</p> <ul style="list-style-type: none"> Admin authorities cannot be modified. To facilitate user management, it is recommended to set the authorities of general users lower than that of senior users.

Step 4 Click **Save**.

 **NOTE**

Click  to modify user information and click  to delete the user.

Modifying Password

Step 1 On the **User** interface, click .

The **Modify User** interface is displayed. See Figure 6-35.

Figure 6-35 Modifying user

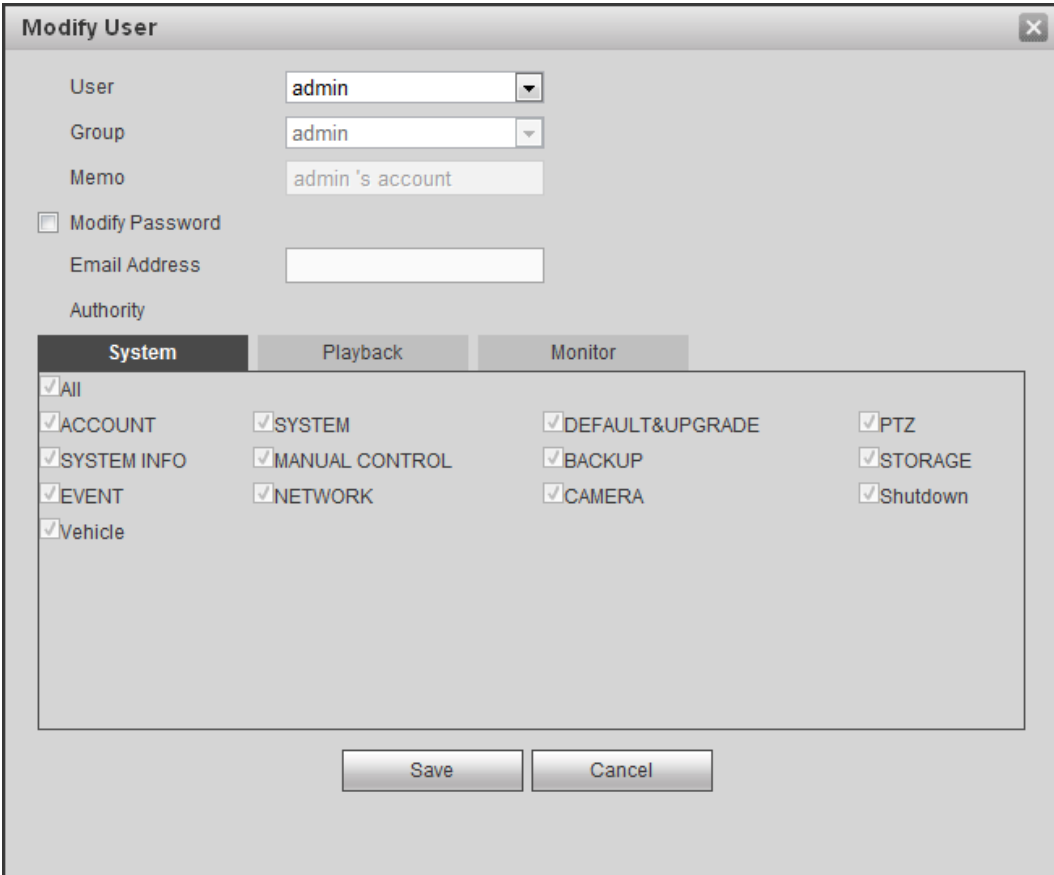

Step 2 Select **Modify Password** check box. Enter the original password, new password and confirm the password.

Step 3 (Optional) Enter the reserved email in the **Email Address** box.

After setting the reserved Email, the system prompts a notice to ask if you want to sync the email box to the connected remote device. Click **Cancel** to cancel the email sync.

 **NOTE**

After setting the reserved email, if you forgot the admin login password, you can reset it via the email. For details, see "6.5.2.3 Reset Password."

Step 4 Click **Save**.

 **NOTE**

- The password can be set from 8 characters through 32 characters and contain at least two types from number, letter and special character. Set a high security password according to the intensity prompt.
- The user with user management authority can not only modify the password of itself, but also that of other users.

6.5.2.2 Group Management





You can add, delete or modify a group on this interface.

Step 1 Select **SETUP > SYSTEM > ACCOUNT > Group**.

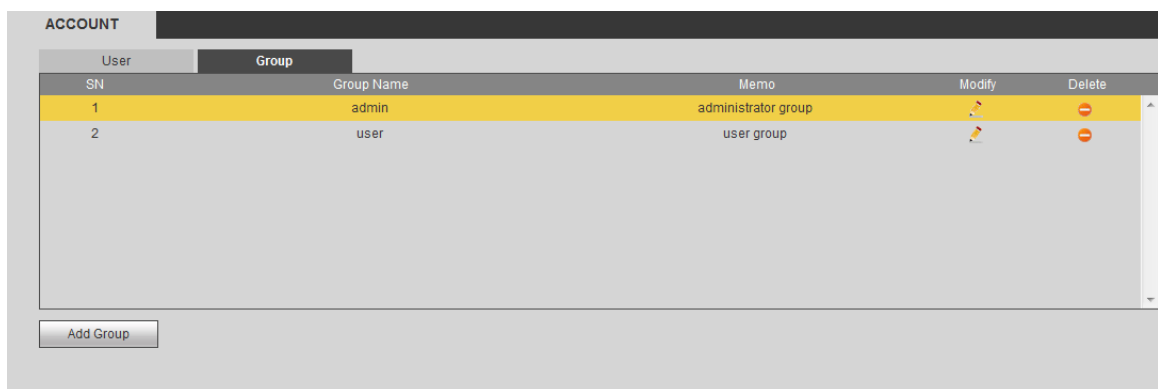
The **Group** interface is displayed. See Figure 6-36.

Figure 6-36 Group



SN	Group Name	Memo	Modify	Delete
1	admin	administrator group		
2	user	user group		

Step 2 Click **Add Group**.

The **Adding Group** interface is displayed. See Figure 6-37.

Figure 6-37 Adding group



The screenshot shows a window titled "Add Group" with a close button in the top right corner. Inside the window, there are three text input fields labeled "Group Name", "Memo", and "Authority". Below these fields is a tabbed interface with three tabs: "System", "Playback", and "Monitor". The "System" tab is currently selected and highlighted. Under the "System" tab, there is a list of checkboxes for selecting authorities: "All", "ACCOUNT", "SYSTEM INFO", "EVENT", "Vehicle", "SYSTEM", "MANUAL CONTROL", "NETWORK", "DEFAULT&UPGRADE", "BACKUP", "CAMERA", "PTZ", "STORAGE", and "Shutdown". At the bottom of the window, there are two buttons: "Save" and "Cancel".

Step 3 Enter the **Group Name** and **Memo**.

Step 4 Select the authorities, including system, playback and real-time monitor.

Step 5 Click **Save**.

 **NOTE**

Click  to modify the corresponding group information and click  to delete the group.

6.5.2.3 Reset Password

When you forget the login password for admin account, you can reset the password through the reserved email box.

Step 1 Log in the Web interface through the browser.

The login interface is displayed. See Figure 6-38.

Step 2 Enter **admin** in the **Username** text box.

Figure 6-38 Login interface

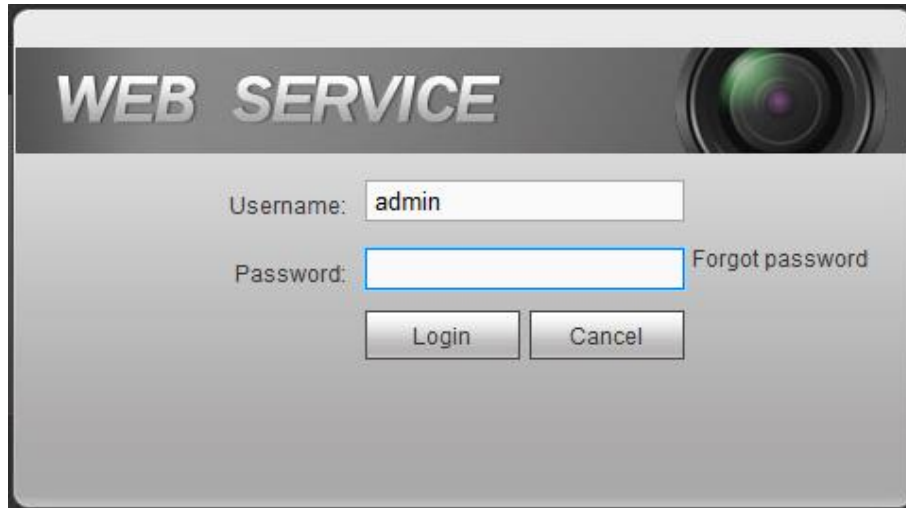

Step 3 Click **Forgot Password**.

The **Password Reset 1/2** interface is displayed. See Figure 6-39.

Figure 6-39 Password reset



Step 4 Send the QR code in the actual interface according to the prompts to get the security code.



CAUTION

- Use the QR code in the actual interface of your device. The above QR code is only for example.
- You can get at most two security codes with the same QR code. If you need more, refresh the interface to get a new QR code.
- The security code is valid for 24 hours.
- If the security code is incorrect for five times, the account will be locked for five minutes.

Step 5 Enter the security code in the corresponding text box.

Step 6 Click **Next**.

The **Password Reset 2/2** interface is displayed. See Figure 6-40.

Figure 6-40 Setting new password

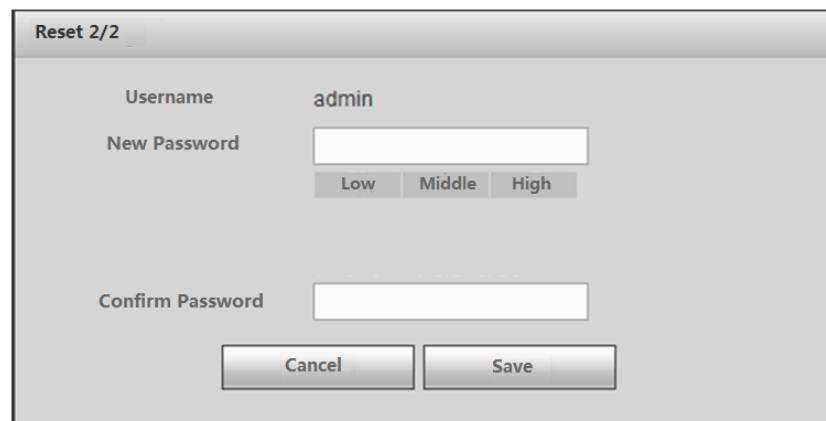

Reset 2/2

Username admin

New Password

Low Middle High

Confirm Password

Cancel Save

Step 7 Enter the new password and confirm the password.

The password is 8 to 32-digit containing letter(s), number(s) and symbol(s). It contains at least two types. Set a high security password according to the strength prompts.

Step 8 Click **Save**.

The system prompts to ask if you want to sync the password to the connected remote device. Click **Cancel** to cancel the sync.

6.5.2.4 Viewing Online Users

View the information of online users connected to the device.

Select **INFO > ONLINE USER > Online User**. The **Online User** interface is displayed. See Figure 6-41.

Click **Refresh** to get the latest information.

Figure 6-41 Online User

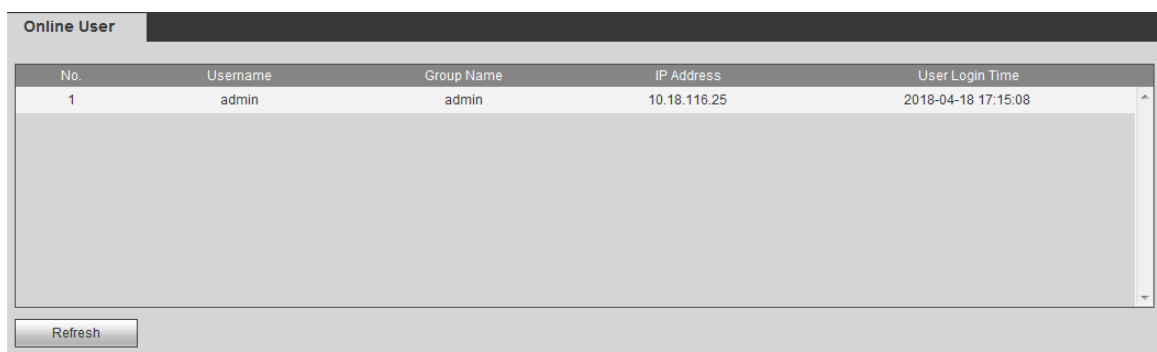

No.	Username	Group Name	IP Address	User Login Time
1	admin	admin	10.18.116.25	2018-04-18 17:15:08

Refresh

7.1 Requirements

In order to ensure the normal and safe operation of the system, it is recommended to manage, back up and maintain the system according to the below operations:

- Regularly inspect the monitoring screen.
- Regularly clear up the unused users and groups.
- Modify user password every three months.
- Regularly check and analyze system logs. Handle abnormalities in time.
- Regularly back up system configuration.
- Regularly reboot and delete old files.
- Timely upgrade the firmware.

7.2 Viewing Device Information

You can view the version information, system logs, satellite information and battery power status.

7.2.1 Viewing Version Information

Select **INFO > VERSION > Version**. The **Version** interface is displayed. See Figure 7-1.

 NOTE

The below interface is only for reference. It is subject to the actual device situation.

Figure 7-1 Version information

VERSION	
Device Type:	Mobile Speed Dome
Record Channel:	1
Alarm In:	1
Alarm Out:	1
SN:	000000000000000000
Web:	3.2.7.94710
Mcu Version	2018-01-17 V1
Onvif Client Version:	2.2.1
System Version:	3.214.0000000.0, Build Date: 2018-03-02

7.2.2 Viewing System Logs

You can check system logs here and also back up them to the local PC.

Step 1 Select **INFO > LOG > Log**.

The **Log** interface is displayed. See Figure 7-2.

Figure 7-2 System Log

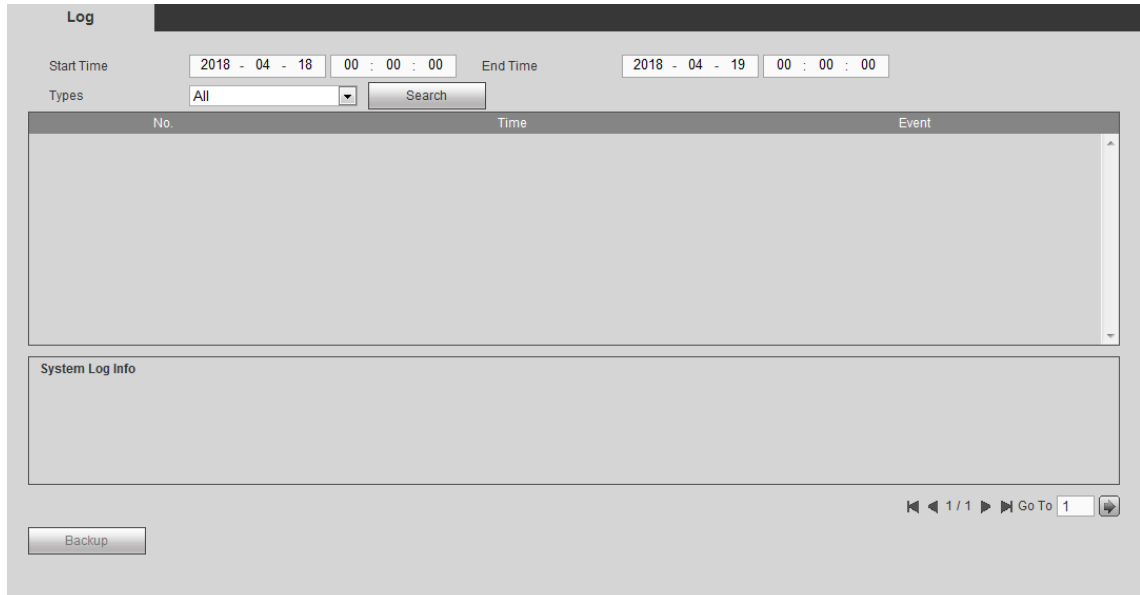

Step 2 Enter the **Start Time** and **End Time** and select the **Types**.

- The start time shall be no earlier than January 1, 2000. The end time shall be no later than December 31, 2037.
- Types include system operation, configuration operation, data operation, alarm events, record management, user management, log clear, file operation and log connection.
 - ◇ System operation: Including application program boot, abnormal exit, exit, application program reboot, close/reboot device, system reboot and system upgrade.
 - ◇ Configuration operation: Including saving and deleting configuration files.
 - ◇ Data operation: Including memory card type, data clear, hot-plug and record mode.
 - ◇ Alarm event (recording video detect, alarm and other abnormal events): Including the event start and event end.
 - ◇ User management (recording user modification, login and logout): Including login, logout and adding/deleting/modifying users and groups.
 - ◇ Log clear: Clear the logs.
 - ◇ File operation: Record playback.
 - ◇ Log connection: Login and logout of remote device users.

Step 3 Click **Search**.

The log list is displayed.



NOTE

Click **Backup** and select the save path to back up the log to local PC.

7.2.3 Viewing Satellite Information

Check the device satellite positioning information, including module status, positioning status, longitude and latitude and star-searching situation.

Select **INFO > SATELLITE INFO > SATELLITE INFO**. The **SATELLITE INFO** information interface is displayed. See Figure 7-3.

Click **Refresh** and the latest information is displayed.

Figure 7-3 Satellite Information

The screenshot shows a mobile application interface titled "SATELLITE INFO". It contains the following data:

Module State:	Abnormal	
GPS Status:	To be positioned	
Speed:	0.0 Km/h	
Position:	LAT:0.00000°	LON:0.00000°
Search Results:	GPS:0/0	
Weak	Satellite No:0	Used Satellite No:0

At the bottom center, there is a "Refresh" button.

7.2.4 Viewing Battery Power Status

Check the battery status, including capacity, voltage and charging or not.

Select **Information > Battery Status > Battery Status**. The **Battery Status** interface is displayed. See Figure 7-4.

Click **Refresh** and the latest status is displayed.

Figure 7-4 Battery power status

The screenshot shows a mobile application interface titled "Battery Status". It contains the following data:

Battery Status		
Capacity	57	%
Battery Voltage	11.355	V
Recharging or not	Yes	

At the bottom center, there is a "Refresh" button.

7.3 Device Reboot

Select **SETUP > SYSTEM > MAINTAIN**. The **Auto Maintain** interface is displayed. See Figure 7-5.

Click **Manual Reboot** to restart the device.

Figure 7-5 Auto maintenance

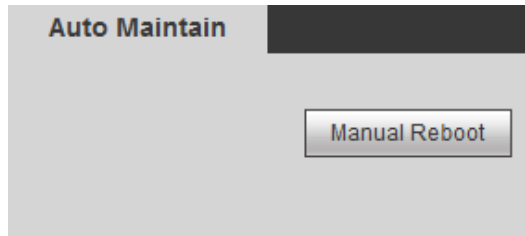

7.4 Backup and Recovery

Back up or restore the configuration on the Web and restore system defaults.

7.4.1 Backing Up Configuration

Back up all the configuration information on the Web.

Step 1 Select **SETUP > SYSTEM > IMP/EXP**.

The **Import & Export** interface is displayed. See Figure 7-6.

Figure 7-6 Configuration import and export



Step 2 Click **Config Export** and select the save path.

The system starts the backup.

7.4.2 Restoring Configuration

Using the backup information, you can quickly configure the device or restore the configuration.

Step 1 Select **SETUP > SYSTEM > IMP/EXP**.

The **Import & Export** is displayed. See Figure 7-7.

Figure 7-7 Configuration import and export

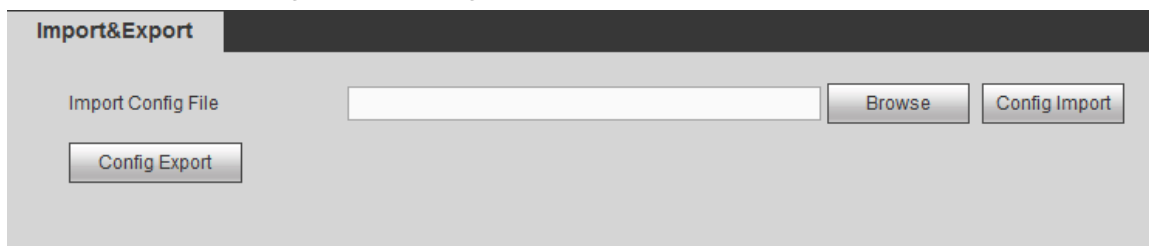

Step 2 Click **Browse** to select the file you need to import.

Step 3 Click **Config Import**.

The **Reboot** dialogue box is displayed.

Step 4 Click **Save**.

The system imports configuration and then reboots.

7.4.3 Restoring System Defaults

You can select the detailed items to restore according to the menu options. Only users with the authority of default & upgrade can restore system defaults.



CAUTION

After restoring factory defaults, the user configurations might be lost. Be careful to perform it.

Step 1 Select **SETUP > SYSTEM > DEFAULT**.

The **Default** interface is displayed. See Figure 7-8.

Figure 7-8 Factory defaults

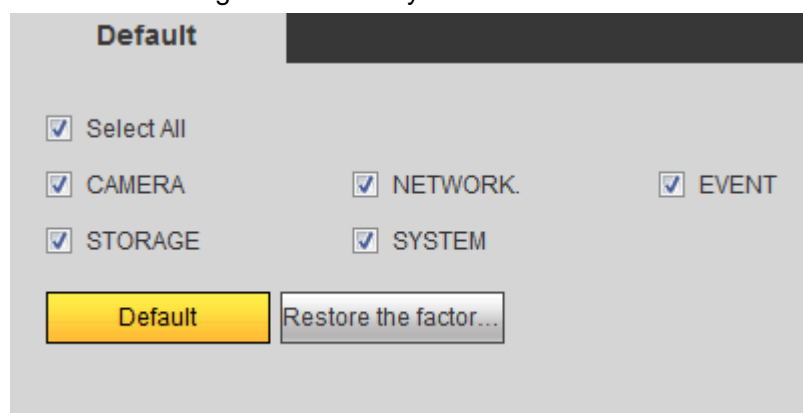

Step 2 Select the items you want to restore factory defaults.

Step 3 Click **Default** or **Restore the factory settings**.

- **Default:** The system deletes the existing configurations and restores the default status.
- **Restore the factory settings:** All the system parameters are restored to factory defaults. Be careful to perform it.

7.5 System Upgrade

Import upgrade files to upgrade the system. Upgrade files are in the type of *.bin.



CAUTION

- During the upgrade process, do not break the power or network and reboot or close the device.
- Upgrade error might lead to device breakdown.

Step 1 Select **SETUP > SYSTEM > UPGRADE**.

The **System Upgrade** interface is displayed. See Figure 7-9.

Figure 7-9 System upgrade

The screenshot shows a web interface titled "System Upgrade". It features a "chiplist" label next to a dropdown menu currently set to "Main". Below this is a "Select Firmware File" label followed by a text input field. To the right of the input field are two buttons: "Browse..." and "Upgrade".

Step 2 Select the **chiplist** according to practical needs.

- When you need to upgrade system programs, select **Main** in the drop-down box.
- When you need to upgrade the firmware program of SCM, select **MCU** in the drop-down box.

Step 3 Click **Browse** to select the file.

Step 4 Click **Upgrade**.

The system starts to upgrade the program. You need to log in Web again after the upgrade.

Click **LOGOUT** to log out the user.

9 DSS Operation

Add the device to the DSS platform and then you can operate and manage the device through DSS. For detailed operations, see *DSS User's Manual*.

Appendix 1 Optional Accessories

When using the device, some accessories can be selected. You need to buy them separately if needed. For the available list, see Appendix Table 1-1.

Appendix Table 1-1 Optional accessories

Accessory	Number	Accessory	Number
8-Pin Aviation Cable	1	External GMouse	1
Sound Pick-up	1	Backup Battery	1
Tripod	1	Battery Recharge Stand	1