

# 1. Installation Instructions

## 1.1 Important Notes

Please read these instructions carefully before installation and keep for future reference.

- Always turn off supplied power to the LED batten before performing installation or maintenance.
- This LED batten must be earthed.
- This LED batten is complete without a ballast.
- Drilling into the batten body will void the warranty - this batten should only be mounted by surface mounting clips.
- Installation and wiring must only be performed by a qualified, licensed electrician.
- Please ensure rated voltage and frequency of the batten is compatible with the power supply.
- Clean with soft cotton cloth only, do not use any chemical solvents when cleaning this batten.
- In case of fitting failure, switch off power to the batten and wait for the fitting to cool. Perform steps 2.3 - 2.8 in reverse to take down the fitting.

## 1.2 Installation Specifications

See table and matching diagram below for mounting information

Model	Length (A)	Fix Span (B)	Clips
LEDBT18WS2	655mm	470mm	4
LEDBT36WS2	1260mm	900mm	8
LEDBT18WSE	655mm	470mm	4
LEDBT36WSE	1260mm	900mm	8

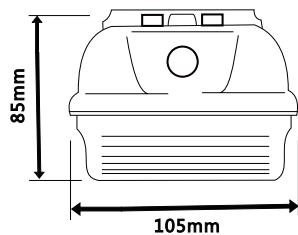
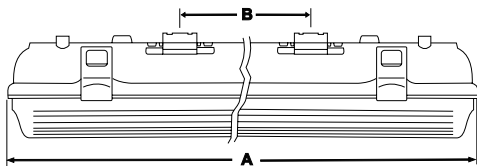

# 2. Installation Procedure

## 2.1 Mounting Clips

The mounting centre points for the LED batten are located on the included mounting clips. Choose a suitable location and fix the clips using included wall plugs & screws.

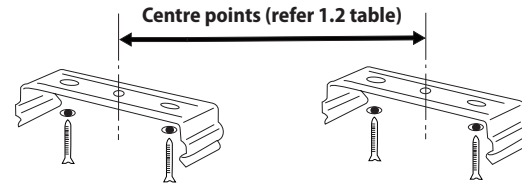

## 2.3 Ceiling or Wall Mounting

Mounting clips span can be slightly adjusted to fit to different installation tolerances. The light can also be wall mounted.

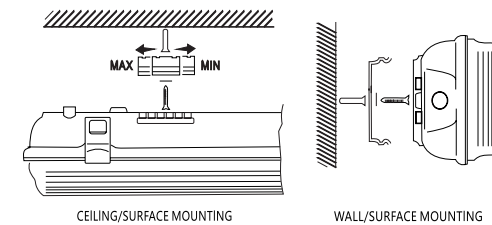

## 2.4 Lock Toggles

Before fitting the batten to the mounting clips, ensure lock toggles are attached to the body.

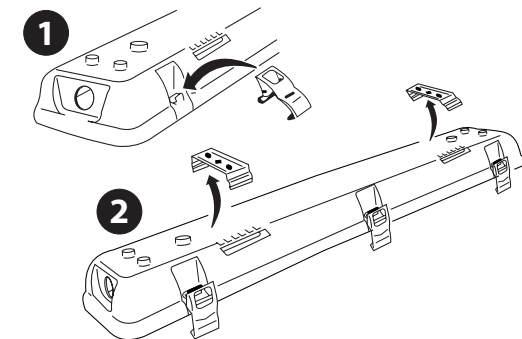

## 2.5 Running Power Cable

Insert main power supply through the gland then tighten the lock nut to the batten body. Make sure there is sufficient cable to reach the terminal block.

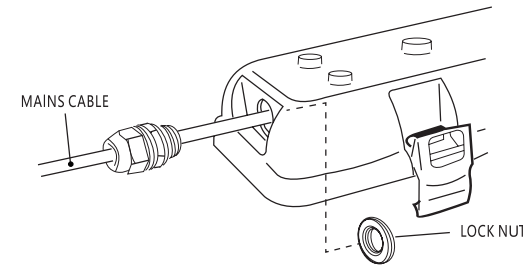

## 2.6 Array Board Safety Cable

Attach the safety cable to stop the array board from falling; enables hands free use.

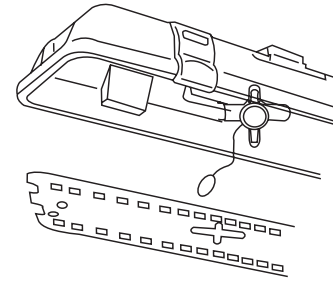

## 2.7 Connect Supply to Terminal Blocks

Connect as illustrated, ensuring the cable is secure with no bare wires and correct polarity.

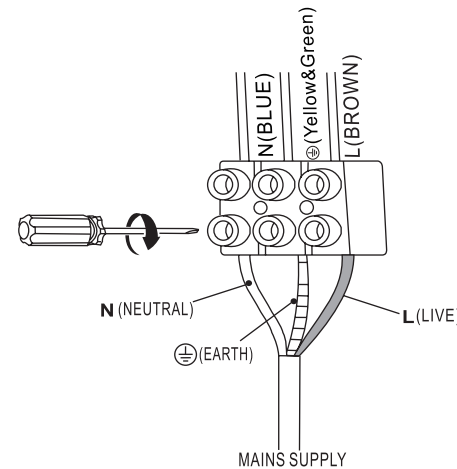

## 2.8 Secure Array Board & Close Cover

Secure the array board with rotating locking clips. Fit the cover to the body, close all lock toggles to complete installation.

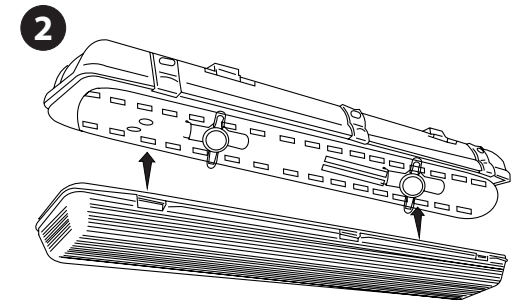
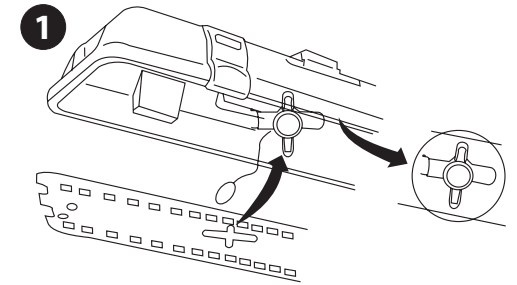

## 2.9 Test & Complete

Switch on main power to test.

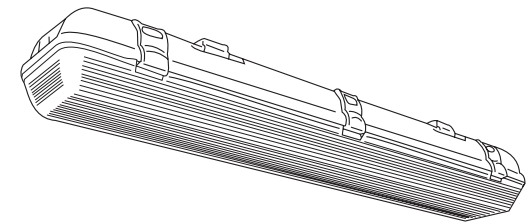

Please keep these instructions in a safe place for future reference.

### 3. Sensor Configuration

Tailor the ENSA Emergency LED Batten to a multitude of environments & applications. Configure detection sensitivity, on-time delay, dimming level and 2-stage dimming control via DIP switches on the unit.

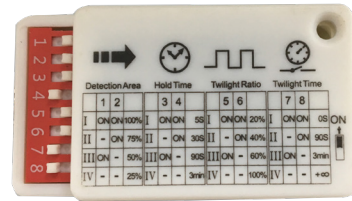

	DIP Switch		Configuration
	1	2	Max. Detection
I	ON	ON	100% (16m)
II	-	ON	75% (12m)
III	ON	-	50% (8m)
IV	-	-	25% (4m)

#### 3.1 Detection Area (Sensitivity) DIP Switches 1 & 2

Configure the 360° microwave motion sensor sensitivity to tailor the motion detection area of the batten to your exact specifications.

Default setting: 100% (16m radius max. Detection)

	DIP Switch		Configuration
	3	4	On-time Delay
I	ON	ON	5s
II	-	ON	30s
III	ON	-	90s
IV	-	-	180s

#### 3.2 Hold Time (On-time delay) DIP Switches 3 & 4

Configure the duration that the light stays at maximum brightness after the last detected motion.

Default setting: 90 seconds

	DIP Switch		Configuration
	5	6	Dimming Level
I	ON	ON	20%
II	-	ON	40%
III	ON	-	60%
IV	-	-	100%

#### 3.3 Twilight Ratio (Dimming level) DIP Switches 5 & 6

Configure the dimmed illumination level after the last detected motion and after the hold time has expired.

Default setting: 20% (of maximum brightness)

	DIP Switch		Configuration
	7	8	Dimmed-time Delay
I	ON	ON	0s (instant off, no dim)
II	-	ON	90s
III	ON	-	180s
IV	-	-	∞s (light remains on)

#### 3.4 Twilight Time (Dimmed-time delay) DIP Switches 7 & 8

Configure the duration that the light stays at dimmed brightness. It can be set to stay dimmed (never off) or turn off instantly (never dim).

Default setting: ∞s (stays dimmed, never off)

### 4. Emergency Mode Configuration

The backup battery provided with your ENSA Emergency LED Batten is designed to provide light uptime in the event of an emergency. The battery ships disconnected to prevent battery discharge. See below for default settings:

- **LEDBT18WSE** - 3000mAh LiFePO4 backup battery, set to 3.6W in emergency (5hr uptime)
- **LEDBT36WSE** - 3000mAh LiFePO4 backup battery, set to 3.6W in emergency (5hr uptime)

Below is the configuration panel for the backup battery, located in the middle of the batten.

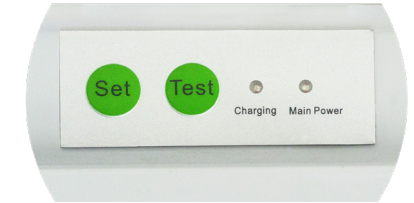
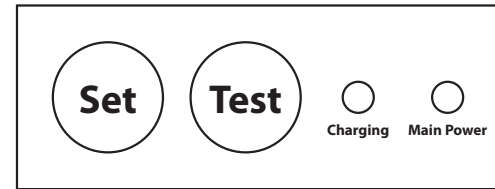

#### 4.1 Test Button

##### Allows for maintenance testing of backup battery

By pressing and holding TEST, the batten will switch to battery power to simulate emergency lighting, even when main power is available. Release the test button to return the light to main power. Performing regular battery maintenance checks is recommended.

#### 4.2 Charging LED (Red)

##### Indicates that the backup battery is charging

- LED constant on: Battery on high rate current charge
- LED 1s on then 1s off: Battery on intermittent or trickle charge
- LED 2 flashes then 2s on: At last self-test, forecast battery uptime was less than 90 minutes.

**Note:** Upon full battery discharge, the batten light may flicker momentarily while recharging.

#### 4.3 Power Supply LED (Green)

##### Indicates that the batten has main power supply

LED On: Main power supplied  
LED Off: No main power available