





## Contents

Features	3
Wireless Hardware	4
IDS & Duevi integration PCB	5
LED operation	5
Wireless Device Hardware setup	6
Location 260	7
LED Keypad Instructions	7
Adding Wireless Detectors	7
Upon Sub menu entry the user will notice the following:	8
Delete Wireless Detectors	9
Signal Power of Received Signal	9
Supervision monitoring	10
Trouble Conditions	11
Reporting Codes	12
Location 300 Global Reporting	12
Location 301 Global reporting	12
Location 302 Global reporting	13
Location 303 Global reporting	13
Location 304 to 335 Zone Reporting	14
Location 336 to 340 Keypad Reporting	14
Location 342 to 373 User Reporting	14
Event Reporting	15
Location 501 to 564 Global Split Reporting	15
Location 571 Global Split Reporting	15
Location 572 Global Split Reporting	16
Location 573 Global Split Reporting	16
Location 574 Global Split Reporting	17
Location 575 Global Split Reporting	17
Appendix	18
Wireless Installation Considerations	18

## Features

1. X64 is a hybrid system that can have wired and wireless zones
2. Wireless zone monitoring:
  - a. Supervision
  - b. Tamper
  - c. Low Battery
  - d. Low signal strength
3. Receiver Monitoring
  - a. RF Jamming
  - b. Tamper
  - c. Bus communication fail
4. Each wireless zone expander handles blocks of 16 sequential zones
5. Each receiver has two outputs which can be set to normal programmable output mode or trigger on supervision and low battery when one of the zones it is monitoring has either of these conditions
6. Four types of wireless devices:
  - a. Indoor 18Kg pet immune PIR
  - b. Outdoor dual head PIR
  - c. Door mag. With an input that works in parallel to the reed switch
  - d. Outdoor PIR and microwave, E-wall



### Warning

1. Older wireless hardware devices will not work with the X64, Duevi integration. Please make sure that you have the correct version of each device.
2. The Duevi wireless peripheral device defaults are:
  - a. Tamper switches disabled.
  - b. Supervision time set to 24 hours on the following devices, 866-DX-PWF Wireless Door Contact, 866-DX-PWF Indoor Wireless PIR
  - c. 90 minutes supervision time for 866-DX-OPWF Outdoor Dual Head PIR and the 866-DX-EWF E-wall
3. Supervision failure will occur when a device does not check in for the time set in; location 260 sub-location 3. The zone will violate and remain violated until the device sends violation signal or a supervision signal.
  - a. Make sure that all devices are set to the correct supervision time.  
For example: If the X64 is set to 24 hour supervision then each device can be set to 24 hour or 90 minute check-in, but if set to 3 hours then each device must be set to 90 minute check-in.
4. Tamper per zone for wireless zones are set the same as wired zones in location 101 to 164 depending on which zones are to be monitored.
5. Wireless receivers can monitor sixteen devices at a time in sequential blocks: zones 1 to 16, 17 to 32, 33 to 48 and 49 to 64. (How to set which receivers monitor which group of zones will be discussed later.)  
For example: A wireless receiver configured to monitor zones 1 to 16 cannot see zone 17 or any other zone that is not in the first sixteen zones, even if it has only one device learnt to it.

## IDS & Duevi integration PCB

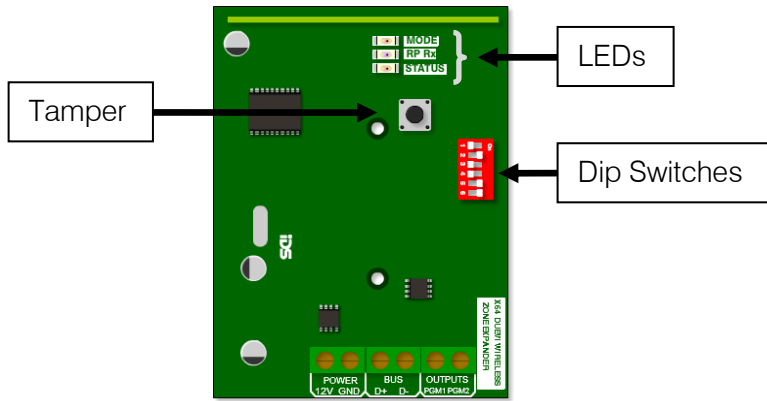

### 1. DIP switch operation

The Dipswitch currently has only two operations. The first is to set the device address on the X64 bus. This is done in binary the same as was done for the wired expander save for one difference. That is that these expanders each cater for 16 zones and not 8 like the wired expander.

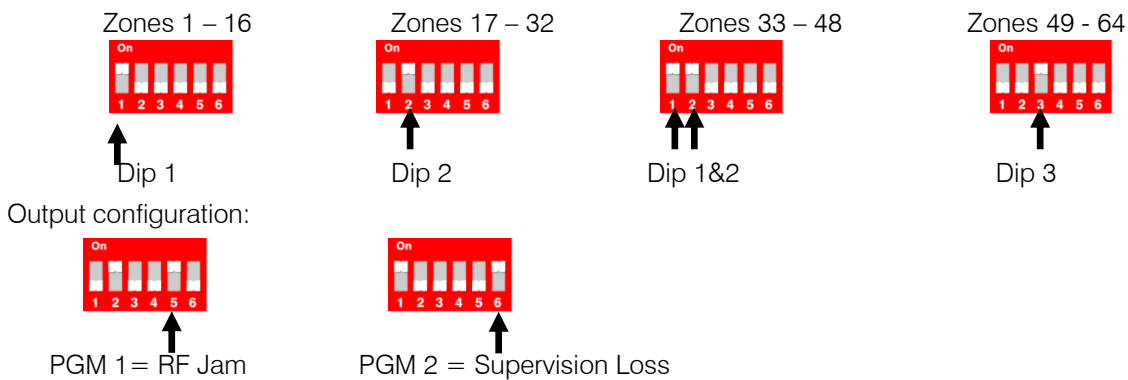

**Note:** When dip switch 5 and 6 are:  
**OFF** the outputs are then programmable.  
**ON** the outputs are by default set to output 1 RF jam and output 2 supervision loss

### 2. Default

The second operation is a standalone default feature. If all Dip-switches are ON during power-up then the unit will default. Please power down after, set appropriate address and power up to resume normal operation.

## LED operation

There are 3 LEDs on the board marked "MODE", "RF RX" and "STATUS".

**MODE:** LED that indicates current operating errors. Errors are indicated much the same as the wired expander. If the LED is ON continuously then there are no errors. However if there are errors it will start pulsing the error number. These error pulses will be separated by a 1sec pause with the LED OFF.

Pulse error number:

1. Duevi receiver module not responding
2. No activity on the X64 serial bus
3. No X64 messages detected
4. No messages for this peripheral detected from X64
5. Not used
6. Expander not yet registered on the X64
7. Expander tamper violated
8. Unsupported DIP address configured

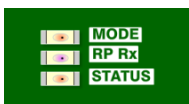

**RF RX:** LED that will indicate when the receiver received a message from a learnt detector.

**STATUS:** LED that will indicate whether it is connected to the X64 properly. If the receiver notices communications then it will stay ON.

X64

## Wireless Device Hardware setup



**Note:** The important thing to remember is that when you have chosen the supervision time of 3Hrs on the X64 is to make sure the detectors are also set to 90min.  
The correct hardware must be used as the older Duevi wireless detectors will not learn to the integrated receiver

### Duevi Outdoor Wireless Dual Head PIR - 866-DX-OPWF

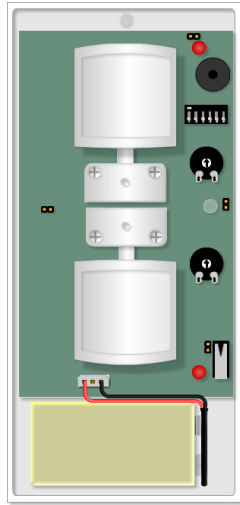

← Dip switch 5: On = 24 Hrs Off = 90 min  
Default: 90 minutes check in



**Note:** To learn the dual PIR to the X64 first get both PIR heads to detect movement then press the tamper switch when in location 260 sub location 1 and the correct zone number has been selected

### Duevi Wireless Door Contact including input - 866-DX-PWF

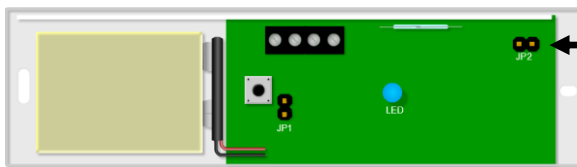

← JP2 jumper: On = 24Hrs Off = 90min  
Default: 24 hours



**Note:** To learn the door contact to the X64 press the tamper switch when in location 260 sub location 1 and the correct zone number has been selected

### Duevi Wireless Indoor Wireless pet tolerant (small pet) PIR - 866-DX-PWF

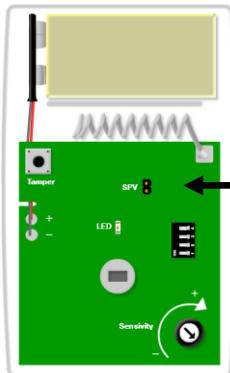

← SPV jumper: On = 24Hrs Off = 90min  
Default: 24 hours



**Note:** To learn the indoor PIR to the X64 press the tamper switch when in location 260 sub location 1 and the correct zone number has been selected

### Duevi Outdoor E-Wall with PIR & Microwave - 866-DX-EWF

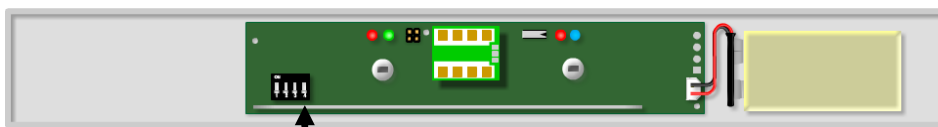

← Dip switch 4: On = 24Hrs Off = 90min  
Default: 90 minutes



**Note:** To learn the door contact to the X64 press the tamper switch when in location 260 sub location 1 and the correct zone number has been selected

## Location 260

Location 260 has a four sub locations listed in the table below:

Sub Location	Description
1	Add Wireless Device
2	Delete Wireless Device
3	Wireless Device Signal Strength
4	Supervision Interval Time



**Note:** Depending if you have an LED or LCD keypad will depend on the feedback you can expect to receive while programming. The following instructions will be broken up into LED keypad, indicated by and LCD keypad indicated by

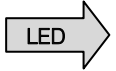

### LED Keypad Instructions

Upon Location entry the user will notice the following:

- a. Ready LED ON, Armed LED ON, Away LED flashing.
- b. Menu system now only awaiting sub location selection.
  - i. User must enter [number][\*] to advance into "sub menu".
- c. When entering sub menus, i.e. add wireless device or delete wireless device. Zones that are wireless zones will be on.
- d. [#] will return user to Installer menu location entry.

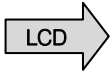
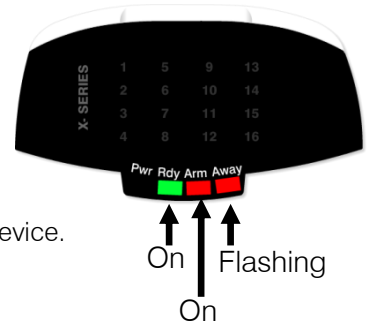

### LCD Keypad Instructions

Upon location entry the following will be displayed

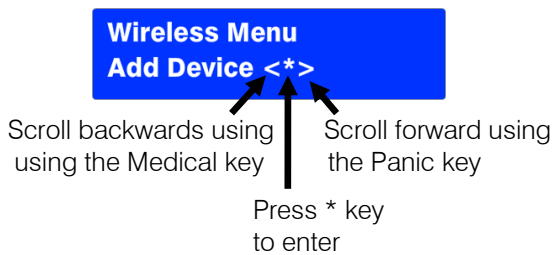

[#] will return user to Installer menu location entry

## Adding Wireless Detectors

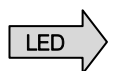

Upon Sub menu entry the user will notice the following:

When working with more than 16 zones on an LED keypad to page through to the next 16 zones press the [\*] key



**Note:** Each time a new page of zones are shown the Pwr, Rdy, Arm and Away LEDs will change to show which zones are being displayed.



Example:

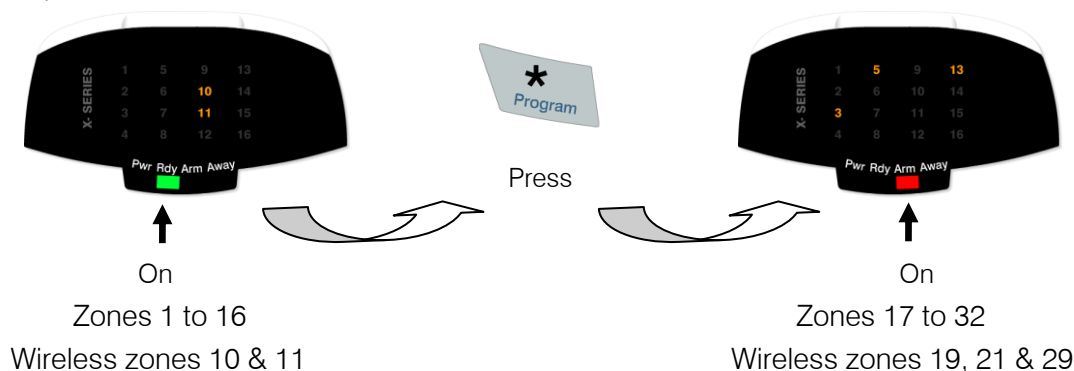



1. Zone LEDs will be ON if the zone already has a wireless detector assigned. The menu is now waiting for user to select to which zone to add a detector. If the user selects a pre-allocated zone then the keypad will sound 3 error beeps and wait for a valid zone entry.



**Note:** Detectors may only be added on LED keypads via the tamper method.

2. Upon valid zone selection the keypad will sound an OK (single beep) and set the zone LED selected to start flashing. The system is now waiting for the new detector to be tampered.

When the user triggers the tamper the system will receive a notification and determine whether the detector has already been assigned to any other zones. If this is the case the user will be notified by 3 error beeps and the menu will keep waiting for a tamper from an unassigned detector.

If the detector has not been assigned then it will be automatically added to the system. The user will be notified via keypad by a LONG OK beep as well as the Zone LED previously flashing will now be ON.

3. The system will now wait for a new zone to be selected.
4. [#] key at any time will return the user back to the sub menu selection menu.

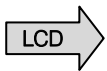

Upon Sub menu entry the user will notice the following:

**Zone Names <\*>**  
**Zone No + \***

← Scroll using Medical or Panic Keys, Enter with [\*] key

← Or enter the zone number followed by the [\*] key

[#] will return user to sub menu selection entry.

Example: If zone name still default

**Zone Names <\*>**  
**02 Zone 02**

Example: If zone name has been changed to "Main Lounge".

**Zone Names <\*>**  
**02 Main Lounge**

Selecting a zone that is a wireless zone already, will result in an error and the user will be alerted with 3 error beeps.

1. Upon selecting a zone that is not already a wireless zone the user will be presented with the following.

**SN: \_ \_ \_ \_ \_**  
**02 Zone 02**

2. Press enter to confirm zone selection

**Tamper or Enter**  
**SN: \_ \_ \_ \_ \_**

The user must now either trigger the tamper on the detector or key in the serial number of the device.

When the user triggers the tamper the system will receive a notification and determine whether the detector has already been assigned to any other zones. If this is the case the user will be notified by 3 error beeps and the menu will keep waiting for a tamper from an unassigned detector.

Incorrect or pre-allocated serial numbers will also result in a 3 beep error tone and the menu will keep waiting for a valid entry.

3. Upon valid Serial Number entry or tamper the user will be presented with the following.

**DUEVI:**  
**12345678    [\*]**

Press [\*] to confirm the serial number is correct

## Delete Wireless Detectors



Upon Sub menu entry the user will notice the following:



**Note:** Each time a new page of zones are shown the Pwr, Rdy, Arm and Away LEDs will change to show which zones are being displayed. Pages are scrolled using the [\*] key.

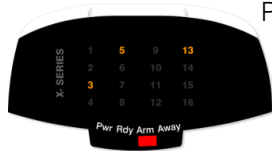
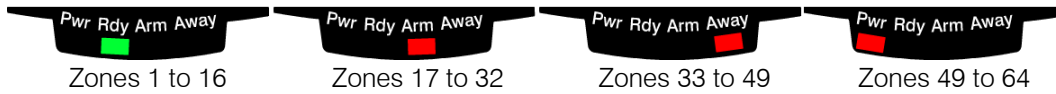

Pages are scrolled using the [\*] key.

1. Zone LEDs will be ON if the zone already has a wireless detector assigned to it. The menu is now waiting for the user to select which zone they want to delete a detector from.
2. Zone LED will turn OFF on zone selection.
3. [#] key at any time will return the user back to the sub menu selection menu.

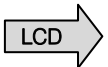

Upon entering location 260 and scrolling to or entering option 2 the following will be displayed:



← Scroll using Medical or Panic Keys, Enter with [\*] key

1. Enter [\*] to enter the delete sub location to have the following displayed:



← Scroll using Medical or Panic Keys, Enter with [\*] key

← Or enter the zone number followed by the [\*] key

2. Enter the zone number or scroll to the zone.



## Signal Power of Received Signal



**NOTE:** This menu is active for the LCD keypad only. The user will need to either trigger the tamper or zone to get a signal power update.



Upon entering location 260 and scrolling to or entering option 3 the following will be displayed:



← Scroll using Medical or Panic Keys, Enter with [\*] key

1. Enter [\*] to enter signal strength testing

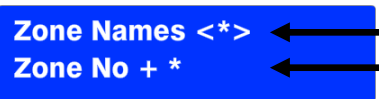

← Scroll using Medical or Panic Keys, Enter with [\*] key

← Or enter the zone number followed by the [\*] key

2. Enter or scroll to the zone to be deleted



← Scroll using Medical or Panic Keys, Enter with [\*] key

← Indicates that this zone is a wireless zone

3. Press the [\*] key to select the zone



4. Trigger the device and the display will show the signal strength on the first row.



← Signal strength displayed in percentage

# Supervision monitoring

Supervision is the monitoring of wireless devices to make sure that they remain communicating with the system. In this sub location you can choose the time that the alarm waits before raising a trouble condition if it has not received a signal from a device.



**Note:** This is not a location that stores a value, but a location that sends the value entered to each wireless receiver. When entering the location the display will be blank.

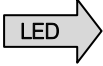

Upon entering location 260 and entering option 4 the following will be displayed

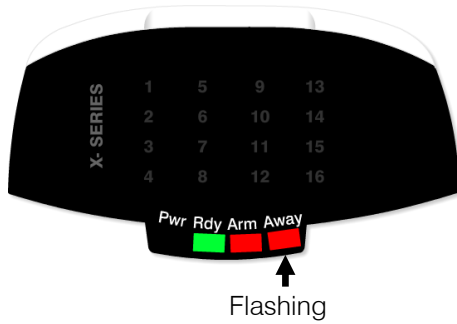

1. Enter the supervision time required by entering the correct option from the following table.

Option	Description
1	3 Hours
2	24 Hours



Upon entering location 260 and scrolling or entering option 4 the following will be displayed:



← Scroll using Medical or Panic Keys, Enter with [\*] key

1. Enter by pressing the [\*] key



← Scroll using Medical or Panic Keys, Enter with [\*] key

2. Enter the option

Option 1



3 hours

Option 2



24 hours

OR



**Note:** When a zone experiences a supervision failure the zone will remain open until such time as the supervision failure is restored.

## Trouble Conditions

### Location 16

Defaults are shown in the on / off column and the added trouble conditions are in bold.

#### How do you know if there is a trouble condition?

The power light on the keypad flashes and begins to beep if enabled in location 14. When the trouble condition has been corrected, pressing and holding **[7]** until the trouble condition is displayed, and then pressing the **[#]** key will clear the power LED trouble condition.

LED	On / Off	Action	Description
1	ON	Enable AC fail trouble display	This trouble condition monitors the AC that powers the Alarm Panel and will register a trouble condition after the time programmed in location 15. This will only clear when AC is restored
2	OFF	Disable reporting comms fail trouble display	This is if the panel tries to communicate and fails to communicate after trying the number of times in location 47
3	OFF	Disable phone line trouble display	A trouble condition will be displayed when telephone line goes down.
4	ON	Enable siren tamper trouble display	This option looks for a load and when this load goes missing a trouble is indicated
5	ON	Enable low battery detection trouble display	The alarm system tests the battery every 30 min. If a trouble is encountered a condition will be shown
6	OFF	Disable Aux. 12V trouble display	When there is a short or some sort of trouble that causes the 12V output to fail
7	OFF	Disable engineer's reset trouble display	If this option is set in partition options (location 211 to 218) and the alarm triggers, this option will show and the alarm can only be armed again once the installer code has been entered.
8	ON	Enable box tamper trouble display	If the alarm control box is fitted with a switch that is connected to the tamper pins on the control board and enabled in location 14 and the door of the box is opened a trouble will be displayed
9	OFF	Disable peripheral tamper trouble display	If any peripheral's tamper have been set and any tampering will cause this option to be displayed
10	OFF	Disable 485 bus fail trouble display	This will display when a device attached to the system via the bus fails and stops communicating
11	OFF	Disable peripheral low power/ battery display	If an expander detects low power on the 12V terminal a trouble condition will be displayed
12	OFF	<b>Wireless battery low</b>	When a wireless device's battery needs to be replaced the device will send a battery low signal and trigger a trouble if enabled
13	OFF	<b>Wireless supervision Monitoring</b>	Each wireless device will check in and if a device does not a trouble is triggered
14	OFF	<b>Wireless RF jam</b>	If an unknown signal that can interfere with signals from wireless is detected a trouble will be triggered
15	OFF	<b>Wireless low RSSI</b>	RSSI is signal strength measurement and if lower than 20% a trouble will be logged
16	OFF	<b>Zone tamper</b>	If a zone is monitored for tamper and then a tamper signal is detected by the alarm a trouble will be triggered.

## Reporting Codes

In the following locations the value of the reporting codes are entered for reporting formats other than SIA and Contact ID. For example formats like, FBI 4x2.

**[INSTALLER CODE] [\*] [LOCATION] [\*] [SUB-LOCATION] [\*] [REPORTING CODE] [\*]**



**Note:** Please take note of the changes to some of the reporting locations to accommodate the new wireless. New wireless additions are highlight in bold text

### Location 300 Global Reporting

Sub Loc	Description	Explanation
1	AC Fail	Enter the code that is to be reported when the main electrical supply has failed and the system is running on the backup battery
2	AC Restore	This reporting code is sent when the main electrical supply is restored
3	Communication Fail	The X64 can be programmed to try and communicate a number of times via the phone line. When these attempts have been exhausted a communication fail is sent.
4	Communication Restored	When communication is restored the code is sent
5	Phone line tamper	If the phone line is tampered with and the line voltage goes missing an alert is sent
6	Phone line restore	When the line voltage is restored a reporting code is sent alerting the security company
7	Siren tamper	The X64 monitors the siren and if it goes missing a signal is sent
8	Siren tamper restore	Once the siren has been restore the security company is alerted

### Location 301 Global reporting

Sub Loc	Description	Explanation
1	Battery Low	After AC has failed and the system detects that the battery voltage has reached 10.5V this code is sent to warn the company that it is about to switch off because of the lack of power
2	Battery Restore	Once charged a restore will be sent to confirm the battery is charged
3	Auxiliary 12V Fuse failed	If the fuse protecting the auxiliary 12V output latches off a code can be sent to alert the security company
4	Auxiliary 12V Fuse restored	When the fault is corrected a restore is sent
5	Installer reset required	If this option is enabled in location 211 to 218 and the alarm is tripped in the partition that it is enabled in, the alarm cannot be armed until the installer code is entered.
6	Installer reset restored	Once the installer code has been entered after an alarm has tripped a restoral will be sent
7	Box tamper	On the alarm panel is a connector that a switch can be connected to monitor the box that it is in so it cannot be opened without notifying the security company
8	Box tamper restore	When the box is closed a restore is sent

### Location 302 Global reporting

Sub Loc	Description	Explanation
1	Bus device tamper	When a device that is connected to the keypad bus registers a tamper this code is sent to the alarm company
2	Bus device tamper restore	When the device on the bus registers that the tamper condition has been restored it will send this code
3	Bus peripheral Communication fail	When a device that has been registered on the bus stops communicating the control panel will send this code to alert the company monitoring the alarm
4	Bus peripheral Communication restore	Once the communication between the control panel and the missing device is corrected a restoral is sent to the alarm company
5	Bus peripheral power/battery low	A device that has the ability to monitor its power detects that it's power is low a message can be sent
6	Bus peripheral power/battery restore	Once the power is restored a signal alerting the monitoring company can be sent
7	<b>Wireless detector battery low</b>	Wireless devices monitor their batteries and when a battery needs changing this low battery code is sent
8	<b>Wireless detector battery restore</b>	After changing the battery a restoral is sent

### Location 303 Global reporting

Sub Loc	Description	Explanation
1	Wireless detector supervision failure	Each device checks in with the controller at a predetermined time and if this signal is not received, the alarm company is alerted that it has gone missing
2	Wireless detector supervision restore	When the wireless device starts communicating after being missing a restoral is sent
3	<b>Wireless receiver signal jam</b>	If the receiver detects a signal that could block effective communication from the devices that it is monitoring an alert is sent to the monitoring company
4	<b>Wireless receiver signal restore</b>	When the signal causing the jam has been removed a restoral is sent
5	<b>Wireless Detector RSSI low</b>	Each detectors signal strength is checked and if the signal strength drops below 20% a low RSSI is sent
6	<b>Wireless Detector RSSI restore</b>	Once the signal strength of a device increases above 20% a RSSI restore is sent
7	Dedicated Panic	On board is a dedicated panic zone, when triggered this code is sent
8	Test report	The X64 can be programmed to send test signals to confirm that it is still alive
9	Download report code	After the system has been connected to by IDSwift software a code is sent.

## Location 304 to 335 Zone Reporting

**[INSTALLER CODE] [\*] [LOCATION] [\*] [SUB LOC] [\*] [REPORTING CODE] [\*]**

Loc	Sub Loc	Description	Explanation
304 to 307	1 to 16	Zone alarm reporting	When the system is armed, a 24Hr zone or a panic zone is triggered this code is reported
308 to 311	1 to 16	Zone alarm restoral	When the zone restores after being violated this code is sent
312 to 315	1 to 16	Zone tamper reporting	If the tamper monitoring option is enabled and a tamper signal is received this code is sent
316 to 319	1 to 16	Zone tamper restoral	Once the tamper condition is corrected a restoral is sent
320 to 323	1 to 16	Zone bypass reporting	If a zone is bypassed and the alarm is armed this code is sent to report which zones are inactive
324 to 327	1 to 16	Forced Arming	If the system is programmed to automatically bypass zones that are violated when arming, this code is sent to alert the monitoring company of inactive zones
328 to 331	1 to 16	Swinger shutdown reporting	If swinger shutdown has been enabled and the alarm automatically shuts down a zone that has violated the swinger shutdown settings
332 to 335	1 to 16	Swing shutdown restore	The system can be set to try and restore a zone that has been disabled by the swing shutdown option and if it is able to restore the zone this code is sent

## Location 336 to 340 Keypad Reporting

**[INSTALLER CODE] [\*] [LOCATION] [\*] [SUB LOC] [\*] [REPORTING CODE] [\*]**

Loc	Sub Loc	Description	Explanation
336	1 to 8	Duress reporting	A user code can be programmed to send a duress signal to alert the security company of a life threatening situation causing the user to disarm the alarm with this code
337	1 to 8	Keypad panic	Each keypad has a panic button which when pressed can send a code alerting the monitoring company of a situation
338	1 to 8	Fire alarm	If a fire is detected and the fire key on the keypad is pressed this code will be reported
339	1 to 8	Medical Key reporting	A medical code can be sent alerting the monitoring company to send an ambulance
340	1 to 8	Keypad lockout	If a code is entered incorrectly the keypad can be set to lock for a period of time and sent this code to alert the monitoring company

## Location 342 to 373 User Reporting

**[INSTALLER CODE] [\*] [LOCATION] [\*] [SUB LOC] [\*] [REPORTING CODE] [\*]**

Loc	Sub Loc	Description	Explanation
342 to 349	1 to 16	Close reporting	Every time a user arms the alarm this code is sent
350 to 357	1 to 16	Stay close reporting	If the user arms in stay mode this code is sent
358 to 365	1 to 16	Open reporting	Every time a user disarms the alarm this code is sent
366 to 373	1 to 16	Siren cancel reporting	When a user enters their code to cancel the siren this code is sent

## Event Reporting

When using contact ID and SIA formats all event codes are programmed into the X64 and only need to be enabled or disabled in the following locations. Also the split reporting group can be allocated.

### Location 501 to 564 Global Split Reporting

These locations are for each of the zones, 501 is for zone 1, 502 is for zone 2, 503 is for zone 3, etc.

LED	ON/OFF	Action	Explanation	Split Reporting Option
1	ON	Zone alarm reporting	If this option is selected whenever a zone is violated the alarm reports via telephone	9 OFF
2	OFF	Zone alarm restore	When the zone restores the alarm reports via telephone	10 OFF
3	OFF	Zone bypassing	When a zone is bypassed it is reported via telephone	11 OFF
4	OFF	Zone force bypassing	When the system is set to bypass zones that are violated when arming it reports that it was forced to arm by bypassing zones	12 OFF
5	OFF	Zone tamper	When tamper has been set for a zone and the tamper signal is received it will be reported via telephone	13 OFF
6	OFF	Zone tamper restore	When the tamper restores a report is sent via telephone	14 OFF
7	OFF	Zone swinger shutdown	A zone shuts down because it has exceeded the shutdown count and the system will report via telephone	15 OFF
8	OFF	Zone swinger shutdown restore	At the auto test report, the system will try and restore the zone if it is not violated and this will be reported via telephone	16 OFF



Options 9 to 16 are to select which split reporting telephone numbers to report too.  
Off = split reporting group 1, On = split reporting group 2

### Location 571 Global Split Reporting

LED	On/Off	Action	Explanation	Split Reporting Option
1	ON	AC fail reporting	After the wait time set in loc.?? The AC failure will be reported	9 OFF
2	OFF	Communication fail reporting	If the system cannot report a failure to report message is sent	10 OFF
3	ON	Telephone line tamper reporting	The alarm monitors the voltage on the telephone line and if that it goes missing a tamper is reported	11 OFF
4	ON	Siren fail reporting	The siren output monitors the load on the output and if it goes missing then a tamper is reported	12 OFF
5	ON	Panel low battery fail reporting	When AC is off and the battery voltage drops to 10.5V a battery low signal is sent, warning that the system is close to shutting down	13 OFF
6	ON	Enable aux 12V fuse fail reporting	If a short circuit or too much current is drawn from the auxiliary 12V the fuse will shut off and send a signal warning of a problem	14 OFF
7	OFF	Installer Reset Required	If installer reset is enabled in loc.211 to 218 and the alarm is triggered the system will not arm until the installer code is entered. This alerts the security company of this	15 ON
8	ON	Box tamper reporting	The alarm has an input that monitors a switch that monitors if the housing that it is in is opened	16 OFF



Options 9 to 16 are to select which split reporting telephone numbers to report too.  
Off = split reporting group 1, On = split reporting group 2



### Location 572 Global Split Reporting

LED	On/Off	Action	Explanation	Split Reporting Option
1	ON	Bus-wired peripheral tamper reporting	Any device connected on the keypad bus is tampered with this option will send a report	9 OFF
2	ON	Bus-wired peripheral fail reporting	A device on the keypad bus fails and stops communicating a report is sent	10 OFF
3	OFF	Bus-wired peripheral low battery reporting *	If a device is powered by a battery because of a power failure and the battery has reached a critical level a low battery signal is sent	11 OFF
4	ON	<b>Wireless Detector Battery Low</b>	When a wireless device's battery needs replacing a battery low signal will be sent	12 OFF
5	OFF	<b>Wireless Detector Supervision fail</b>	If a device stops communicating after a set amount of time a supervision failure is sent	13 OFF
6	OFF	<b>Wireless Receiver Signal Jammed</b>	When a signal is detected that could block signals from the wireless detectors a jam is reported	14 OFF
7	OFF	<b>Wireless Detector RSSI Low</b>	RSSI is the monitoring of signal strength from detectors and if the signal drops below 20% a message will be sent to alert the security company	15 OFF
8	ON	AC Restored	After AC is restored a message can be sent	16 OFF



**Note:** Options 9 to 16 are to select which split reporting telephone numbers to report too.  
Off = split reporting group 1, On = split reporting group 2

### Location 573 Global Split Reporting

LED	On/Off	Action	Explanation	Split Reporting Option
1	OFF	Comms Restored	When the system is able to communicate after a failure a restoral is sent	9 OFF
2	OFF	Comms Tamper Restore	If the lines went down and when they start working again a restore is sent	10 OFF
3	OFF	Siren Restore	If the siren went missing and is reconnected a restore will be sent	11 OFF
4	OFF	Battery Restore	After a battery low is reported and the battery is changed or charged a restore will be sent	12 OFF
5	OFF	Aux 12V Restored	After a short circuit or too much current being drawn is fixed the fuse will restore and send a signal	13 OFF
6	OFF	Installer Reset restored	After an installer reset required condition is reset a signal will be sent	14 OFF
7	ON	Box tamper restored	When the box that the system is housed is closed a restore is sent	15 OFF
8	ON	Bus device tamper restored	When the device on the keypad bus that was tampered is restored a signal will be sent	16 OFF



Options 9 to 16 are to select which split reporting telephone numbers to report too.  
Off = split reporting group 1, On = split reporting group 2

### Location 574 Global Split Reporting

LED	On/Off	Action	Explanation	Split Reporting Option
1	OFF	Bus device comms restored	When a device has stopped communicating on the bus and when the fault is corrected and communication is restored a signal is sent to confirm this.	9 OFF
2	OFF	Bus device battery restored	A device that reported a low battery on the bus will send a restore when the battery voltage is full and report the restoral condition	10 OFF
3	OFF	<b>Wireless detector battery restored</b>	Once the wireless devices battery is changed it will respond by sending a restore	11 OFF
4	OFF	<b>Wireless detector supervision restored</b>	When a device starts communicating after being marked as missing by the system a supervision restoral is sent	12 OFF
5	OFF	<b>Wireless receiver jam restored</b>	After detecting a strong signal that could cause wireless devices from communicating is switched off a restoral will be sent	13 OFF
6	OFF	<b>Wireless detector RSSI low restored</b>	A device that recorded a low signal recovers and the signal comes up to an acceptable level a restoral will be sent	14 OFF
7	ON	Dedicated Panic	The X64 has a dedicated panic onboard and if this is triggered a panic signal will be sent	15 OFF
8	ON	Test Report	The alarm can be configured to send a test report every 6 hours to every 14 days	16 OFF



Options 9 to 16 are to select which split reporting telephone numbers to report too.  
Off = split reporting group 1, On = split reporting group

### Location 575 Global Split Reporting

LED	On/Off	Action	Explanation	Split Reporting Option
1	OFF	IDSswift Download Accessed	This option reports when the system has been communicated with by the download software	9 OFF



Options 9 to 16 are to select which split reporting telephone numbers to report too.  
Off = split reporting group 1, On = split reporting group

## Appendix

### Wireless Installation Considerations

1. Receivers may be blocked by radio signals on or near their operating frequencies, regardless of the code selected. IDS wireless works on 433MHz, so do transmitter remotes.
2. Receivers can only respond to one transmitted signal at a time.
3. Wireless equipment should be tested regularly, at least once a week, to determine if there are sources of interference and to protect against faults.
4. Some wireless devices when their batteries run low can begin to send random signals flooding the area.
5. Do not install next to any electrical wiring. Make sure that there are none imbedded in the wall.
6. Different materials have different effect on wireless signals. Any material that has a high rating should be kept as far away as possible and not in between the device and receiver. When installing, do not install closer than 1 meter.

The following table provides more information about the degree to which some materials can interfere.

### Relative Attenuation of RF Obstacles

Obstruction	Degree of Attenuation	Example
Open Space	None	Courtyard, Football field
Wood	Low	Inner wall, office partition, door, floor
Plaster	Low	Inner wall (old plaster lower than new plaster)
Synthetic Materials	Low	Office partition
Cinder block	Low	Inner wall, outer wall
Asbestos	Low	Ceiling
Glass	Low	Non-tinted window
Wire Mesh in Glass	Medium	Door, partition
Metal Tinted Glass	Medium	Tinted window
Human Body	Medium	Large group of people
Water	Medium	Damp wood, aquarium, organic inventory
Bricks	Medium	Inner wall, outer wall, floor
Marble	Medium	Inner wall, outer wall, floor
Ceramic (Metal Content or Backing)	High	Ceramic tile, ceiling, floor
Paper	High	Roll or stack of paper stock
Concrete	High	Floor, outer wall, support pillar
Bulletproof Glass	High	Security booth
Silvering	Very High	Mirror
Metal	Very High	Desk, office partition, reinforced concrete, elevator shaft, filing cabinet, sprinkler system, ventilator

