

## INSTRUCTION MANUAL FOR

# Rhino GTS

**Code Hopping Remote Control Car Alarm with Two Stage Impact Sensor, Battery Backup Siren & 2 Point Engine Immobilisation**



N517



**SYDNEY / AUSTRALIA**

Version 2.0

### TO ARM/DISARM ALARM

The alarm is activated by pressing **BUTTON 1** on the remote control transmitter once. The blinkers will flash once, and the siren will beep once. The dash LED-light will stay on for 15 seconds then flash, **THE ALARM IS NOW ON.**

To deactivate the alarm, press the **BUTTON 1** again. The blinkers will flash twice and the siren will beep twice. **THE ALARM IS NOW OFF.**

If the siren is sounding, and you wish to disarm, the first press will cancel the siren - the system will then return to an armed state. A second press is required to fully turn the alarm off (you will hear 2 beeps & the blinkers will flash twice).



**For audible arm / disarm** use **BUTTON 1.**

**For silent arm / disarm** use **BUTTON 2.**

### ARMING ERROR REPORT & BYPASS

The alarm can identify 6 different trigger inputs as shown in the table below. When arming, if the alarm senses a trigger from any one of these inputs it will beep out the corresponding code to the that trigger input 4 seconds after the normal arming beep. That trigger input will be automatically bypassed to prevent false alarms.

### ALARM TRIGGER & MEMORY

When the alarm is triggered the siren will sound for 30 seconds and then will automatically rearm.

If the alarm has been triggered in your absence, the dash LED will be flashing twice as fast as normal when you return to your vehicle. To find out what has triggered the alarm, disarm the system & then turn the ignition to on. The red dash LED will flash out a code to identify what inputs have triggered the alarm during the last armed period. The most recent trigger will be reported last i.e. if the alarm was triggered by the impact sensor, & then triggered again by ignition activation, the LED will flash 3 times, pause, and then flash 4 times. Refer to table below.

Trigger	Indication Chirp(s) for Bypass, given 4 seconds after arming	Alarm Memory Report Via LED (Flashes) given after disarm when ignition is turned on
Door Circuit	1	1
Bonnet/Boot	2	2
Impact Sensor	3	3
Ignition Activation	4	4
Voltage Drop (Current) Sensing	5	5
Optional Sensor Input	6	6

### BOOT RELEASE - Available on cars fitted with electric boot release motors.

The alarm is fitted with remote boot release capability. This feature enables the user to unlock the boot by pressing **BUTTON 1** for **3 seconds**. The boot will unlock and the indicators will flash 10 times.

**If the system is armed at the time**, it will automatically bypass relevant trigger sectors i.e. impact sensor, boot trigger, & voltage drop. Once you close the boot, the system will rearm all inputs immediately. Note: If you do not open the boot during the period when the blinkers are flashing 10 times, the siren will trigger when you open the boot. For safety reasons, the remote boot release will not work when the ignition is on.

## TEMPORARY DISABLE

On occasions where you may wish to leave a pet in your vehicle, or leave your windows down while having optional ultrasonic sensors fitted, you can temporarily disable the trigger inputs that would cause an unwanted trigger i.e. you can disable for one arming period the impact sensor, ultrasonic or microwave sensors if fitted, and voltage drop sensing. The alarm will still trigger from door, boot, bonnet, and ignition inputs. To activate temporary disable, when arming press **BUTTON 1** or **BUTTON 2** twice in a row with a 1 second pause between the first & second presses. You will be given a confirmation chirp for each press.

## EMERGENCY PANIC BUTTON

The panic feature is activated by pressing & holding **BUTTON 2** on the remote control transmitter for 3 seconds. If disarmed, the alarm system will arm first (i.e. lock doors) then the siren will sound & the blinkers will flash for 30 seconds. If armed, the alarm system will stay armed (i.e. the doors will not unlock) & the siren will sound & blinkers flash for 30 seconds.

To cancel "panic", follow disarm procedure as described on page 1.

NOTE: Panic does not work when the ignition is on by requirement of Australian Law (EPA-Environmental Protection Authority).

## PRE-ALERT (2 STAGE) IMPACT WARNING

This special feature provides a two stage impact sensing system. It gives the security conscious owner a sensitive car body impact sensor that will give a potential thief prior warning that the vehicle is protected by this most formidable alarm system. On detection of a low level impact i.e. from a tyre kick, the siren will simply beep 5 times to warn away the would-be thief. If the vehicle is attacked any further, the system will move into full siren mode. The sensitivity level reference point can be adjusted to suit your particular needs. Please refer to the programming section contained later in this manual.

## PROGRAMMABLE FEATURES:

The features outlined below are the most popular that can be turned on or off to suit your requirements. Please refer to the section in this manual marked "Rhino Programmable Features" for full details.

**PASSIVE ARMING:** The alarm can automatically arm itself 30 seconds after you leave your vehicle provided that the ignition is turned off, and that at least one door has been opened and closed i.e. the owner has parked and has exited the vehicle. This feature will not lock the vehicle where central locking is connected.

**AUTOMATIC RE-ARM:** This feature prevents accidental disarming by the owner i.e. The owner turns the alarm off but is then distracted and forgets that they have deactivated the system. If a door is not opened, or the ignition is not turned on within 60 seconds from when the system is turned off by the remote, the system will re-arm, and if central locking is connected, it will re-lock the vehicle.

**SILENT ARM/DISARM:** This feature when turned on, stops the siren from beeping for arm & disarm confirmation i.e. only the blinkers will flash.

## LEARNING NEW REMOTES (Up to 3 remotes can be used with this alarm system)

Before entering this mode, make sure you have all remotes present that you wish you utilise with this alarm system, as the alarm automatically erases all remotes when you enter this mode.

- A. Arm then Disarm the alarm system. While the system is disarmed, open and close your driver's door (get inside the vehicle), making sure the interior light is coming on as you open the door.
- B. Within 30 seconds, turn the car ignition key from the off position to the ignition on position 20 times. 30 seconds later, the blinkers will flash 3 times to confirm that you have entered the remote learning mode. Repeat steps A & B if you do not receive the flashes.
- D. Now press & hold the button on the new remote you wish to learn in. The siren will beep once to confirm the code has been learnt. Repeat this step for up to 3 remotes. You can use this process to delete lost remote controls by learning in the same remotes in succession to replace each of the 3 memory locations so that the old remote code/s are erased.
- E. The system will automatically exit the learning mode 15 seconds after the last press of a remote.

# ALARM MODEL: RHINO GTS

## STANDARD SYSTEM FEATURES

- ❖ 2 x Code Hopping Remote Controls ( Anti - Scanning, Anti - Code Grabbing)
- ❖ Smart Code Learning Technology
- ❖ 2 Point Engine Immobilisation (Onboard Relays)
- ❖ Protects Doors, Boot, Bonnet
- ❖ 2 Stage Car Body Impact Sensor
- ❖ Multi-Tone Backup Battery Siren
- ❖ Flashes Indicators
- ❖ Flashing Red Dash Light
- ❖ Central Locking Control for Keyless Entry
- ❖ Arm/Disarm Beep
- ❖ Emergency Panic via Remote
- ❖ Current (Voltage Drop) Sensing
- ❖ Automatic Siren Reset (30 seconds)
- ❖ Security Override Mode
- ❖ Boot Release via Remote (where fitted)
- ❖ Sensor Isolation via Remote
- ❖ Alarm Memory
- ❖ Split System - Separate Siren & Brain



## SELECTABLE SYSTEM FEATURES

- ❖ Shock Sensor Sensitivity Adjustment via Remote
- ❖ Passive Arming
- ❖ Auto Rearm & Relock
- ❖ Arming Delay Time Adjustable (15 - 95 seconds)
- ❖ Audible or Quiet Arm/Disarm
- ❖ Silent Operation
- ❖ Current Sensing (Voltage Drop) Circuit
- ❖ Central Locking Output Time Selectable - 0.8 or 5 Seconds

## OPTIONAL ACCESSORIES :

Automatic Electric Window Lift	(Part No. GLU400 - Closes 2 Windows)
Paging System	(Part No. APAGER)
Ultrasonic Sensors	(Part No. UD6)
Microwave Detector Dual Zone	(Part No. MDDZ)



# *PROGRAMMABLE FEATURES*

## *for Rhino GTS Car Alarm*

Your Rhino Security system incorporates the latest in high security & convenience features. It is possible to customise your security system so that it suits your requirements perfectly. Detailed below is the full list of programmable features that can either be turned on or turned off.

We have set at the factory, the most common configuration chosen and these settings are listed in the REGISTER Settings listed below. Once the desired features have been selected, the selection is permanently retained in memory, even if power is removed.

**To turn on or turn off any feature use the following procedure: eg to enable silent arming.**

1. Arm then disarm the alarm system.
2. Within 10 seconds of disarming, turn the ignition key to on.
3. Press button 1 on the remote control (immediately after turning the ignition on) an equal number of times to the selected feature's code no. (eg 6 times for Audible arm/disarm). Leave a 0.5 sec. gap between each press. The siren will chirp to confirm each press.
4. Immediately turn the ignition to off after the last press.
5. The system will now confirm whether the feature has been turned on or off via visual readout. One flash of the indicators means the feature is on. Two flashes means the feature has been turned off.

PROGRAMMABLE FEATURE	Press Remote This Many Times	Indication	INITIAL FACTORY SETTING	DESCRIPTION
Audible Arm/Disarm	6	1 Flash On 2 Flash Off	ON	This feature when turned off, stops the siren from beeping for arm & disarm confirmation i.e. only the blinkers will flash.
Voltage Drop (Current) Sensing	7	1 Flash On 2 Flash Off	OFF	If deactivated, this feature will prevent the alarm triggering via sensing a drop in voltage in the vehicle's electrical system. This may be necessary where engine thermo fans cut in automatically or there are other accessories active even when the ignition is turned off eg. fridges, car phones.
Passive Arming	8	1 Flash On 2 Flash Off	OFF	The alarm can automatically arm itself 30 seconds after you leave your vehicle provided that the ignition is turned off, and that at least one door has been opened and closed ie. the owner has parked and has exited the vehicle. This feature will not lock the vehicle where central locking is connected.
Auto Re-arm	9	1 Flash On 2 Flash Off	ON	If system is disarmed and a door is not opened, or the ignition turned on within 60 seconds, the system will rearm & relock (where central locking is connected).

Silent Operation	10	1 Flash On 2 Flash Off	OFF	When on, this feature stops the siren from sounding on alarm trigger. The alarm will still trigger, flashing the indicators etc. Indication via optional paging system may be desired instead of siren noise. Arm & Disarm beeps are still given, & panic will still sound the siren.
Bypass all inputs except Ignition on passive arm	11	1 Flash On 2 Flash Off	ON	When on, this feature will only let ignition trigger the alarm when it passive arms. If off, all inputs will be active when the alarm passive arms.
Central Closure	12	1 Flash 0.8 2 Flash 5 sec	0.8 sec	You can select the lock & unlock outputs to become a 5 second negative pulse instead of 0.8 seconds. This feature is for certain vehicles with vacuum central locking or those with a central closure wire (some BMW, Mercedes) ie doors lock, electric windows wind up, sunroof closes automatically.
Arming Delay Adjustment & Door Ajar Warning	14	Flash 14 times.	15 sec	You can increase the arming delay period in 4 second increments from the initial minimum factory setting of 15 seconds up to 95 seconds. Press Button 1 to increase delay from present setting by 4 seconds with each press. A confirmation chirp will be heard for each press. Press Button 2 to decrease delay if required. Turn the ignition to on to exit this mode. <b>Door Ajar Warning: When the arming delay is set on 15 sec, if a car door is left open, when arming the siren will emit an error chirp after the normal arming beep. The alarm will also isolate the door trigger input to prevent trigger in case of a faulty door pin switch. If arming delay is extended from 15 sec, this feature will not work. This may be necessary in vehicles that have an interior light delay.</b>
Impact Sensor Sensitivity Adjustment	15	Flash 15 Times	Maximum Sensitivity	There are 25 levels of adjustment for the impact sensing system. Press Button 1 to decrease sensitivity by one level from present setting with each press. A confirmation chirp will be heard for each press. Press Button 2 to increase sensitivity if required. Turn the ignition to on to exit this mode. If no buttons are pressed within 15 seconds the system will exit this mode also.
Security Reset Code	18	No of Flashes is the Code	10	The security reset code relates to the Security Override Mode detailed later in this manual. Choose a Code number between 5 & 25. Press Button 1 to increase code from factory setting of 10 by one digit i.e. 1st press will change code to 6, second press changes code to 7 and so on. Press Button 2 to decrease the code. A confirmation chirp will be heard for each press. Turn the ignition to on to exit this mode.

# WIRING INSTRUCTIONS FOR RHINO GTS ALARM

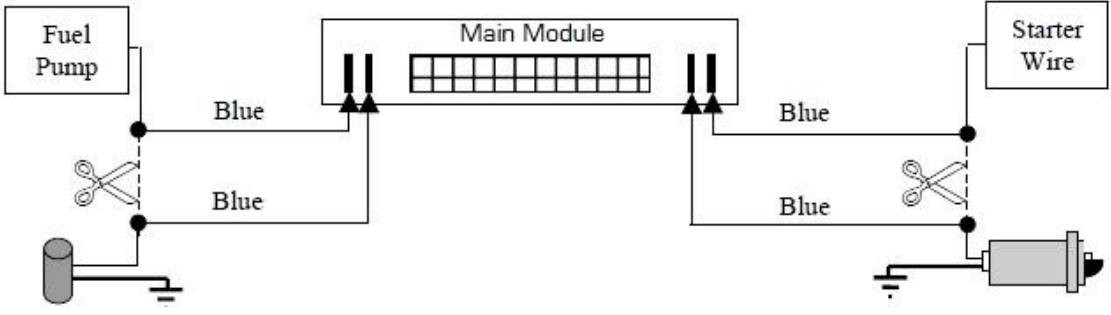
<b>RED</b>	Power. Connect to constant +12 volts via the fuse box at the point where the interior light circuit is powered. Current (voltage) sensing will not work if this procedure is not followed.
<b>BLACK</b>	Earth. Connect to a suitable earth on the car body.
<b>GREEN (x2)</b>	Indicator Flash Wires. Connect to the left and right indicator circuits of the vehicle.
<b>WHITE/GREEN</b>	Ignition Input. Connect to a +12 volts ignition switched lead, which does not fall to 0 volt when the engine is cranked
<b>GREY</b>	Negative Trigger Input. Connect to negative trigger output wire from optional ultrasonics or microwave sensor.
<b>YELLOW</b>	Positive Siren Trigger (1Amp max rating). This wires switches positive when the alarm is triggered. It also pulses positive to make the siren beep. Connect to the yellow positive trigger input wire on the SBB Multi-Tone Backup Battery Siren.
<b>BLUE/GREEN</b>	Negative LED Output - already connected to the LED supplied.
<b>BLUE x 2 with Spade Terminals. (2 Pairs)</b>	<p>Immobilisation Circuits. (Starter Motor &amp; Fuel Pump). The starter wire is usually located under the steering column of the vehicle. This wire must be +12 Volts only when the vehicle is being started. Cut this wire. The vehicle should not start. Solder the starter motor side to one of the blue wires. Solder the other end to the other blue wire. Repeat this configuration for the electric fuel pump. Under no circumstances should you cut the vehicle's main ignition system.</p> 
<b>WHITE/YELLOW</b>	Negative on Arm (200mA Max). Connect to the negative wire (usually black) on any accessory used ie. Ultrasonic or microwave detectors. Also used to trigger electric window lift modules.
<b>PINK</b>	Connect to existing door switches. Please note: only negative switching doors, if positive door switching - must use relays to reverse to negative - see diagram contained later in this manual)
<b>VIOLET</b>	Bonnet Switch Negative Input. Connect to bonnet switch supplied.
<b>WHITE/RED</b>	Negative Boot Release Output (200mA Max). Please refer to the illustrated diagram for connection details. Additional 40A Changeover Relay Required.
<b>ORANGE</b>	Negative Out on Alarm. Use to interface to pager or additional siren (200mA maximum)
<b>BLACK/BLUE</b>	Unlock NC. Refer to diagrams contained later in this manual for central locking connection.
<b>GREEN/YELLOW</b>	Unlock COM. Refer to diagrams contained later in this manual for central locking connection.
<b>RED/BLUE</b>	Unlock NO. Refer to diagrams contained later in this manual for central locking connection.
<b>BLUE/YELLOW</b>	Lock NC. Refer to diagrams contained later in this manual for central locking connection.



<b>RED/GREEN</b>	Lock COM. Refer to diagrams contained later in this manual for central locking connection.
<b>BLACK/GREEN</b>	Lock NO. Refer to diagrams contained later in this manual for central locking connection.
<b>BROWN</b>	Not Used

**CURRENT SENSING**

The alarm is fitted standard with current sensing. This feature incorporated in Rhino systems has been proven to be very reliable. The alarm will detect any sudden drop in voltage in the vehicle's electrical system, for example if the interior light comes on, or if the electrical system shows a voltage drop through tampering. **PLEASE NOTE:** If removal of this feature is necessary i.e. if engine cooling fans run after the ignition key is turned off, please refer to the Programmable Features section of this manual. You are able to disable the current sensing feature so that a false alarm condition can not occur.

# RHINO GTS ALARM WIRING DIAGRAM

REFER TO WIRING INSTRUCTIONS ON PAGE 6 & ABOVE FOR FULL EXPLANATION

**SBB Backup Battery Siren**

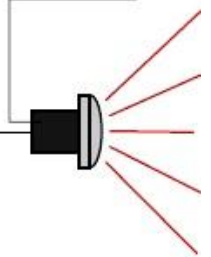
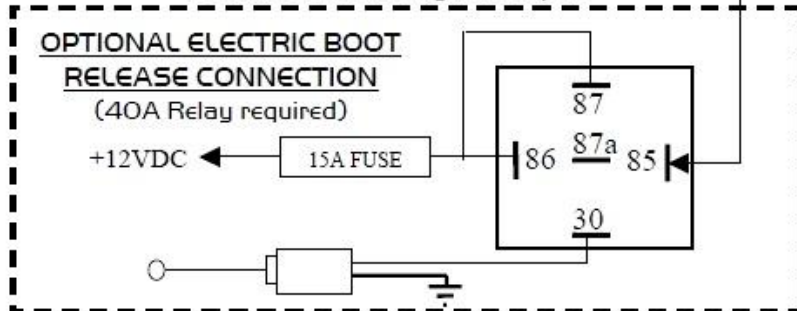
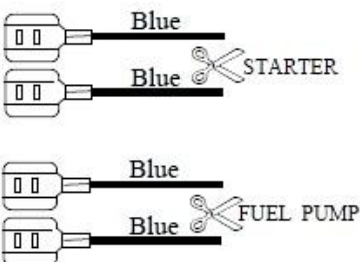
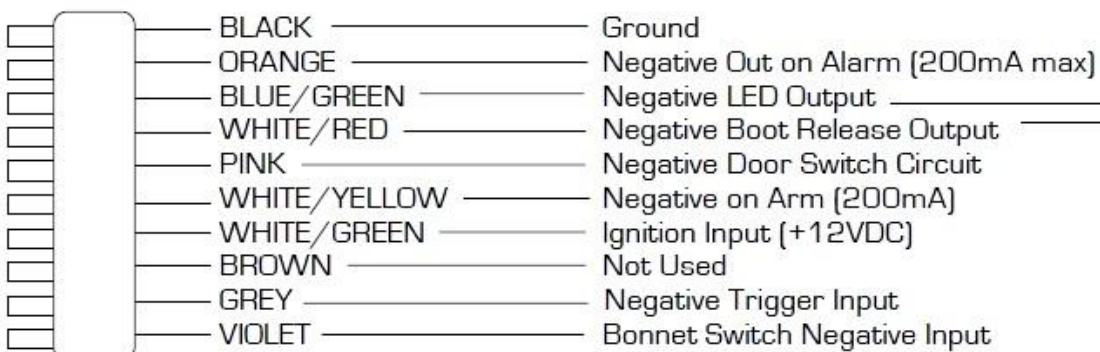
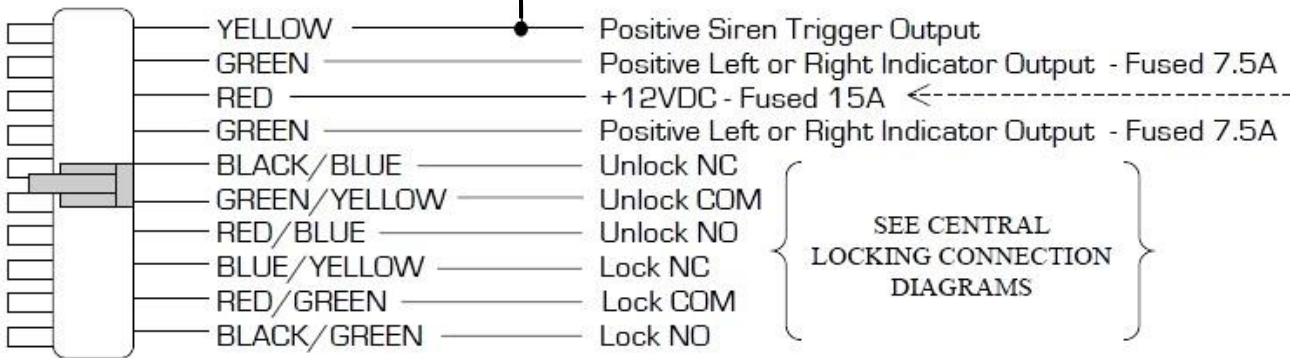
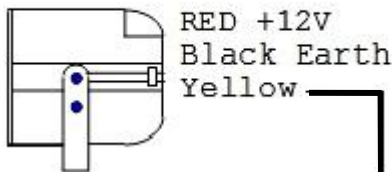

## LOCATION GUIDE FOR SYSTEM COMPONENTS

**THE SIREN:** Mount the siren to the vehicle's firewall, close to the bonnet. DO NOT mount near the exhaust manifold or low down in the engine bay where it may be exposed to excessive moisture / road grime etc.

**THE CONTROL (MAIN) UNIT:** Mount under the dash between the steering column & the centre of the vehicle. Cable tie the unit to a large cable (20mm diameter or larger) or to a heavy strut.

## SECURITY OVERRIDE MODE:

If a customer loses a remote control, or it fails to disarm the alarm system, the following procedure will disarm the alarm system.

1. Open & close the driver's door - sit in the vehicle. (The siren will sound).
2. Within 30 seconds, turn the ignition from off to on 10 times (initial factory security override setting – can be changed from 5 - 25 times - see Programmable Features Section contained earlier in this manual). Wait for 30 seconds.
3. The system will then disarm (the siren will stop sounding), but the blinkers will flash for 3 minutes.
4. Contact your Rhino Dealer for further assistance.

**IMPORTANT NOTE FOR INSTALLERS: Vehicles fitted with negative or positive switching doors.**

In order for the alarm system to function correctly, it is necessary for the doors to be hard wired to the system. Please follow the wiring diagrams below:

**NEGATIVE SWITCHING DOORS:**      **POSITIVE SWITCHING DOORS:** Use relay.

