



# Rhino JAGv3/RAv3



**AUSTRALIAN STANDARDS APPROVED  
REMOTE CONTROL ENGINE IMMOBILISER  
AND ALARM.**



- This product complies with AS/NZS 3749.1 2003 Class A. Volumetric Sensing must be enabled to comply with a Class A installation (refer 'feature programming').
- Class A VSAS (Vehicle security alarm system) includes control equipment including setting and unsetting facilities, all sensors, warning devices and provisions for immobilization of the vehicle and the volumetric sensing device (glass break/shock).
- This product complies with AS/NZS 3749.1 2003 Class B. Volumetric Sensing must remain disabled to comply with a Class B installation (refer 'feature programming').
- Class B VSAS (Vehicle security alarm system) includes control equipment including setting and unsetting facilities, all sensors, warning devices and provisions for immobilization of the vehicle.
- This product complies with AS/NZS 4601:1999/Amdt 1: 2003
- This product is to be installed in accordance with the methods & principles detailed in AS 3749.2:1997

**Has your insurer specified fitting a "RES2001"?**  
For details, please refer to page 13

Override code:



## Instruction Manual

*Thank you for purchasing a Rhino Alarm and Engine Immobilisation system.  
Please read this manual carefully before commencing installation and keep it in a safe place for future reference.*

# Contents

System Features .....	3
Standard System Features .....	3
Selectable System Features.....	3
Optional Accessories.....	3
Detailed Feature Descriptions.....	4
Automatic Immobilisation.....	4
Automatic re-arm & relock (Programmable).....	4
Door Ajar Warning (Programmable).....	4
Timed Headlight Delay (Optional connection by installer at extra cost).....	4
Perimeter Night Light (Programmable).....	4
Dome Light Extension (Programmable).....	4
Glass Break Sensor.....	4
Door Lock on Ignition (Programmable).....	5
Pre-Alert (2 Stage) Car Body Impact Warning with ETS™.....	5
Auto Bypass.....	5
Alarm Operation.....	6
Remote Control Functions:.....	6
Activate Panic or Car Finder Function.....	7
Remote Boot (Trunk) Release.....	7
Programming Additional Remote Controls / Erasing Lost Remote Controls.....	7
Overriding the Immobiliser .....	7
Overriding the Immobiliser .....	8
Programming .....	8
How to Program the Selectable Features: .....	8
Detailed Example:.....	9
How to Change REGISTER 1: .....	9
How to Change REGISTER 2: .....	12
Installation.....	13
“RES2001” Insurance Requirements.....	13
Installing the Main Control Unit.....	13
Internal Connector Diagram .....	13
Factory Remote Interface .....	14
Modes of Operation: .....	14
Inhibit mode (Register 1 Feature 10): .....	14
Enable mode (Register 1, Feature 10): .....	15
Learn Mode (Register 1, Feature 9):.....	15
Turbo timer instructions.....	16
Interface with external turbo timers .....	16
On-board turbo timer .....	17
WIRING INFORMATION .....	18
Installing the Coded Battery Backup Siren (BBSC / MiniBBSC):.....	20
Installing Additional Sirens (non-coded).....	20
Installing Timed Headlight Delay .....	21
Connecting to an Existing Electric Boot (Trunk) Release Motor .....	21
Central Door Lock Diagrams .....	23
WARRANTY TERMS & CONDITIONS .....	25

## **System Features**

### **Standard System Features**

- Microprocessor Controlled
- Three Point Engine Immobilisation (Onboard Relays)
- Auto Immobilise (Passive Arming)
- Code Hopping Remote Technology (Anti-Scanning, Anti-Code Grabbing)
- Two SSR™ Solid State Remote Controls with 4 Function Operation (Arm / Disarm, Boot Release, Panic)
- Long Life Lithium Cell Remote Control Batteries (Each Remote Uses 2 x CR2025)
- Automatic Re-arm in case of Accidental Disarm
- Ultra-Bright Red Flashing LED Light
- Visual Arming and Disarming via Indicators (1 Flash For On, 2 Flashes For Off)
- Safety Circuit Prevents Arming While Ignition On
- Learning Mode for Adding Additional Remote Controls (maximum of 5)
- Negative On Alarm Output for Optional Internal Cabin Siren
- Onboard Central Locking Relay Outputs
- All points of entry alarm protection (doors, boot, bonnet)
- Personal panic button via remote control (siren sounds & indicators flash)
- Auto Bypass (prevents false alarms caused by faulty sensors / or switches)

### **Selectable System Features**

- Arm / disarm beeps (if optional siren fitted)
- Door ajar warning (indicators flash & siren (if fitted) beeps for 3 seconds if a door is left ajar i.e. Vehicle's interior light circuit sees door in open position)
- Electric boot release output via remote control – no delay (standard feature is to hold button for 3 seconds)
- Timed headlight delay (optional feature at additional installation cost)
- Multiple vehicle remote control (control 2 cars separately from the 1 remote)
- Central closure (allows electric window / sunroof closure on arming of some vehicles)
- Door lock on ignition (anti hi-jack)
- Perimeter night light (indicators hold on for 20 seconds on disarm)
- Dome Light Extension (interior light turns on for 20 seconds on disarm)
- User programmable override code in case of loss or damage of remotes (over 63,000 possible codes)
- Compatible with Transformer interface for vehicles with factory keyless entry systems. Allows for factory remote controls to arm/disarm the system.
- Compatible with Wireless Keypad to allow arm/disarm of the system without remote controls.
- In-built 2 stage pre-alert car body impact sensor with ETST™
- Audio discriminating glass break sensor
- Alarm memory (allows recall of the 10 most recent alarm activations in order)

### **Optional Accessories**

- Internal Cabin Siren (Part No: DPS)
- Ultrasonic Sensors (Part No: UD6)
- Microwave Sensor (Part No: UD5)
- Electronic Tilt Sensor (Part No: TILTSENSE2)
- Paging System (Part No: APAGER)
- Wireless Keypad (Part No: WKPB)

## **Detailed Feature Descriptions**

### **Automatic Immobilisation**

The immobiliser will automatically activate 38 seconds after the ignition is switched off - This is indicated via the dash mounted LED, which will illuminate to confirm the system has entered auto immobilise mode. During this time the vehicle cannot be started until a valid remote has disarmed the system. After disarming, if the ignition is not switched on before 38 seconds have elapsed, the alarm will again go into auto immobilise mode.

### **Automatic re-arm & relock (Programmable)**

This feature prevents accidental disarming by the owner i.e. the owner turns the immobiliser off but is then distracted and forgets that they have deactivated the system. If a door is not opened or ignition turned on within 60 seconds from when the system is turned off by the remote, the system will **fully re-arm & re-lock the vehicle**.

**Note:** The immobiliser will enter auto immobilise mode after 38 seconds (the LED will come on constantly to indicate the vehicle is immobilised). At the 60-second mark, the system will fully arm & the doors will lock – the blinkers will flash once & the siren will beep once & the LED will start flashing.

### **Door Ajar Warning (Programmable)**

If the vehicles doors are not properly closed when you try to activate your immobiliser system, the indicators will flash and the siren will beep for 3 seconds to alert you that the vehicle is not secure.

### **Timed Headlight Delay (Optional connection by installer at extra cost)**

You can have your car headlights turn on automatically for 15 seconds when you arm the immobiliser by remote control. This may allow you for instance to see your way to your front door, or out of a dark car park. You can turn the lights off before the 15-second period ends by pressing the left button on your remote.

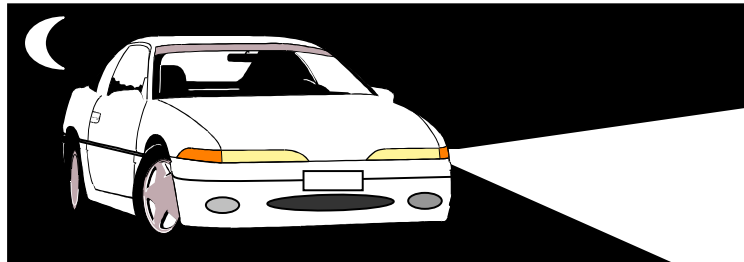

### **Perimeter Night Light (Programmable)**

When this feature is on, the indicators will stay on constantly for 20 seconds on disarm, or until the ignition is turned on. This allows for illumination around the vehicle at night.

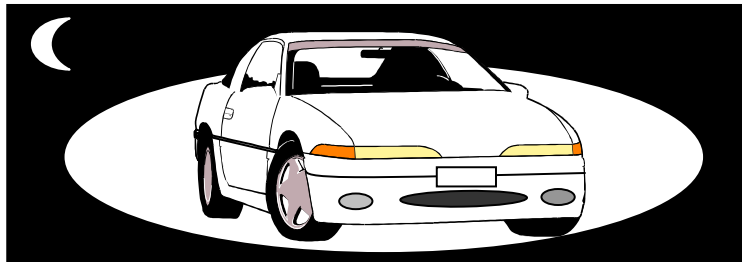

### **Dome Light Extension (Programmable)**

The dome (interior) light comes on automatically when the system is disarmed via remote, enabling the owner to verify the vehicle is safe inside. The light stays on for 20 seconds, or until the ignition is turned on. The dome (interior) light also comes on automatically when the ignition is turned off, enabling the owner to quickly gather belongings before exiting the car. The light stays on for 20 seconds, or until the system is armed via remote, or until the ignition is turned on again. NOTE: If you activate the Automatic Rearm & Relock Feature, this feature will be disabled.

### **Glass Break Sensor**

The Jagv2/Rav3 with the addition of a special cabin microphone incorporates intelligent glass break sensing circuitry. This inbuilt device will trigger the alarm system, provided it registers the correct sound frequency parameters for breaking glass & that the impact sensor also registers a corresponding vibration to the vehicle. This ensures accurate detection of glass breakage.

### **Door Lock on Ignition (Programmable)**

If you have central locking connected, when this feature is on the doors will lock when the ignition is turned to on, and unlock when the ignition is turned to off. This is to prevent anyone but occupants in the vehicle from being able to open the doors.

### **Pre-Alert (2 Stage) Car Body Impact Warning with ETS™**

This special feature provides a two-stage impact sensing system. It gives the security conscious owner a sensitive car body impact sensor that will give a potential thief prior warning that the vehicle is protected by this most formidable alarm system. On detection of a low level impact i.e. from a tyre kick, the siren will simply beep for a few seconds to warn away the would-be thief. If the vehicle is attacked any further, the system will move into full siren mode. The unique ETS™ Environment Tuned Sensor is able to distinguish between environmental shocks caused by aircraft, trucks, or extreme weather conditions, and the impact caused by any thief attempting to break in or other heavy impacts. Furthermore the system features the unique Rhino "Auto Adjust" process, where during the 45 sec. arming delay, the alarm samples the background noise where the vehicle is parked, and will if necessary automatically reduce the sensitivity of the impact sensor to an appropriate level. This process allows a trouble free sensitivity that ordinary alarms simply cannot provide. The sensitivity level reference point can be adjusted to suit your particular needs. Please refer to the programming section contained later in this manual.



### **Auto Bypass**

Auto bypass is designed to reduce false alarms caused by faulty switches or external sensors. If the alarm is triggered 3 times by the same sector then the particular sector will be bypassed. (i.e. the sector will become inactive.) The sector will only be bypassed for one arming period. The next time the system is armed the sector that was bypassed will again become active.

# Alarm Operation





## *Remote Control Functions:*



<b>Remote Control Symbols</b>	<b>Action on Alarm</b>
	Arm/Disarm the Alarm System
	Hold for Boot Release
	Alarm Panic Mode
<b>Optional</b>	Optional 4 <sup>th</sup> Channel for Home Alarm

## Arming and Disarming Your Immobilizer

### TO ARM YOUR IMMOBILISER (& lock your vehicle if central locking is connected)

Pressing the /  button on the remote control transmitter activates the immobiliser. The blinkers will flash once and the siren will beep once. For **silent arm / disarm** press /  and  both buttons. If central locking is connected, your doors will lock. The dash LED-light will stay on for 20 seconds then flash, **THE IMMOBILISER IS NOW ON.**



Press /  button

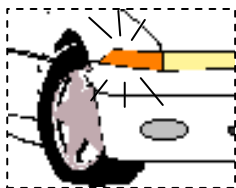

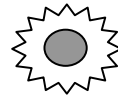
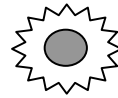
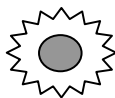

Blinkers will flash once



LED COMES ON.....and after 20 seconds starts to flash.

### TO DISARM YOUR IMMOBILISER (& unlock your vehicle if central locking is connected)

To deactivate the immobiliser, press the /  button. The blinkers will flash twice and the siren will beep twice. The LED will stop flashing. If central locking is connected, your doors will unlock. **THE IMMOBILISER IS NOW OFF.** **Note:** If the alarm has been activated in your absence, the siren will beep 4 times on disarm.



Press /  Button

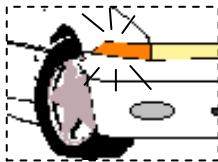

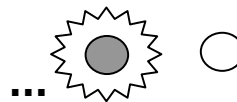

Blinkers will flash Twice



LED Switches OFF

### EMERGENCY PANIC / CAR FINDER FUNCTION

The panic / car finder feature is activated by pressing the  button on the remote control transmitter for **3 seconds**. This causes the indicators to flash (i.e. same as hazard lights) and the siren to sound. To cancel "panic", press the  button on the transmitter for **3 seconds** again.

**Note:** Panic will not activate while the ignition is on by requirement of Australian Law (DECC).

### Remote Boot (Trunk) Release





*BOOT (TRUNK) RELEASE (Optional connection by installer at extra cost)*

This immobiliser is fitted with remote boot (trunk) release capability for vehicles with existing electric boot (trunk) release. This feature enables the user to unlock the boot (trunk) by pressing the  button for **3 seconds**. The boot will unlock, and the immobiliser will disarm. **NOTE:** For safety reasons the remote boot (trunk) release will not work when the ignition is on.

**Note:** Boot release can be programmed to trigger instantly on pressing the  button.

### Programming Additional Remote Controls / Erasing Lost Remote Controls

Your Jagv2/RAV3 is supplied standard with 2 remote controls - Up to a maximum of 5 remotes can be used. To add a new remote to your alarm, simply follow the procedure below:

1. Turn the vehicle's ignition to on.
2. Immediately press and hold the /  button on the original remote control until the indicators start to flash (approximately 4 seconds) and then release the button.
3. Immediately press and hold the /  button on the new remote control for at least 4 seconds.
4. Turn the vehicle's ignition off.
5. The new remote control is now programmed into the immobiliser.

**Erasing Lost Remote Controls:** If you lose a remote control or perhaps have your car keys stolen, you can simply erase the lost/stolen remotes by repeating the procedure above 10 times. This will fill the system memory with remotes that only you have in your possession.

### Learning in a new remote when no working remote is available:

You may learn in a remote without having an already learnt-in remote. Please see "Overriding the Immobiliser" for more information.



## Overriding the Immobiliser

### PROCEDURE:

Your alarm has been loaded with a randomly generated 5 digit override code. This feature enables the owner to override their immobiliser and start the vehicle in the case of lost or damaged remote controls. **The customer must be made aware of this code, which is placed, on the front of this manual and the supplied override code card.**

#### To enter your override code:

1. Enter the vehicle. If the alarm is armed the siren will sound - this may be turned off using your siren key but will not affect the procedure.
2. Ensure that the bonnet and boot are shut, your vehicles doors may be open or closed.
3. Turn the ignition from ON to OFF in a quick steady rhythm an equal number of times to the first PIN digit
4. Wait for the indicators to flash once. If the alarm is armed you will not be able to see the flash, instead watch for a flash on the red dash LED
5. Repeat steps 3 and 4 for the second PIN digit, remembering to wait to see the indicators or dash LED flash.
6. Repeat until all five PIN digits have been entered.
7. If the code has been entered correctly, the alarm will disarm. Start the vehicle within 38 seconds or the alarm will automatically immobilise and the procedure will need to be repeated. If you make a mistake during code entry and the alarm does not disarm, please wait at least one minute before trying again.

**Note:** This procedure will have to be repeated each time you wish to start the vehicle without a working remote. To learn in a new remote when all remotes have been lost, repeat the above procedure with the door and the bonnet open. After the final pin digit has been entered the indicators will begin to flash - Immediately press the / button on the new remote control twice and hold this button on the second press for three seconds. The new remote should now be learnt to the system.

## Programming

Your Rhino Security system incorporates the latest in high security & convenience features. It is possible to customise your security system so that it suits your requirements perfectly. Detailed below is the full list of programmable features that can either be turned on or turned off.

We have factory set the most common configurations as listed in the REGISTER settings below. Once the desired features have been selected, the selection is permanently retained in memory, even if power is removed.





### How to Program the Selectable Features:

1. **By referring to pages 10 – 13 of this manual, find the REGISTER in which the desired feature to be programmed is located. That is, REGISTER 1 or REGISTER 2.**

*For example, to program the 'Door Lock on Ignition' feature, see REGISTER 1.*

2. **Set the vehicle up as described to access the appropriate REGISTER.**

*Taking the same example from Step 1: the 'Door Lock on Ignition' feature is in REGISTER 1. The appropriate vehicle setup for REGISTER 1 is – **all doors closed**. The appropriate vehicle setup for REGISTER 2 is – **driver's door open**.*

3. **Arm then disarm the alarm using /. Then, switch the ignition on, then off, then on again. Now the feature is ready to be programmed using  of the remote.**
4. **Within 3 seconds, begin to press  an equal number of times to the selected feature code. Each press of the remote will be confirmed by a flash of both the indicators and the dash LED; a confirmation beep will also be produced.**



Following the previous example, programming the 'Door Lock on Ignition' feature requires three presses of . This will change the setting of the feature from OFF (factory default) to ON.

5. Turn the ignition to off.

6. The system will then confirm if the feature has been set to ON or OFF. One beep will be produced from the siren if the selected feature has been turned ON. Two beeps will be produced from the siren if the feature has been turned OFF.

**Detailed Example:**

To program the 'Door Lock on Ignition' Feature (REGISTER 1; Feature 3):

1. Ensure that the vehicle's doors are closed and the ignition is switched off.
2. Arm and then immediately disarm the alarm.
3. Turn the ignition to ON.
4. Within 3 seconds, turn the ignition OFF.
5. Within 3 seconds, turn the ignition to ON.
6. Within 3 seconds, press  three times.
7. Turn the ignition OFF.
8. The feature has now been set. You will now hear 1 confirmation beep for ON or 2 confirmation beeps for OFF.

**How to Change REGISTER 1:**

**Vehicle Set Up:** ALL DOORS CLOSED AND IGNITION ON → OFF → ON

**Remote Key action:** TURN ON / OFF FEATURES VIA THE  BUTTON ON THE REMOTE

FEATURE	Press Remote This Many Times	FACTORY SETTING	DESCRIPTION
Arming & Disarming Beeps	2	ON	1 beep on Arm & 2 beeps on Disarm.
Door Lock on Ignition (Anti-Hijack)	3	OFF	When this feature is on, the doors will lock when the ignition is turned to on, and unlock when the ignition is turned to off.
No Door Ajar Warning	4	OFF	When this feature is on, the door ajar warning feature is removed (the siren & indicators will <u>not</u> beep & flash for 3 sec. if a door is not closed properly).
Perimeter Night Light	5	OFF	When this feature is on, the indicators will stay on constantly for 20 seconds on disarm, or until the ignition is turned on. This allows for illumination around the vehicle at night.
Instant Boot Release	6	OFF	When this feature is on, the boot release button (Left Button) will only require be pressing once rather than holding down for 3 seconds to open an electric boot.
Dome Light Extension (Interior lights on when ignition off, interior lights on when system disarmed via remote). <b>Note:</b> This feature cannot be turned on if Auto-Rearm & Relock is activated. See register 2.	8	OFF	The dome (interior) light comes on automatically when the system is disarmed via remote, enabling the owner to verify the vehicle is safe inside. The light stays on for 20 seconds, or until the ignition is turned on. The dome (interior) light also comes on automatically when the ignition is turned off, enabling the owner to quickly gather belongings before exiting the car. The light stays on for 20 seconds, or until the system is armed via remote, or until the ignition is turned on again.

Inhibit / Enable Mode Selection for Upgrade inputs	10	Inhibit	<p>Inhibit mode – NEG1 and NEG2 become inhibit wires which stop the upgrade interface from arming/disarming the alarm i.e. usually connects to the motor switch wires so that when they open the door with the lock manually it will NOT disarm the alarm</p> <p>Enable mode – POS2 input becomes an 'enable' wire which must go positive to allow the upgrade interface to arm/disarm the system. This is usually connected to the blinkers, as they will activate when the factor remote is pressed only.</p> <p>NOTE: Enable mode POS2 wire in Upgrade Learnt mode will learn the required state.</p>
Shock Sensor Adjustment	11	6 SELECT the level required.	<p>After pressing the remote 11 times to enter this mode, turn the ignition to off. There are 8 levels of adjustment. The factory default setting is level 6. Pressing the remote once will increase the sensitivity by one level i.e. to level 7. The LED will then flash seven times to confirm the new level. Pressing the remote again will increase the sensitivity to level 8 (max). Pressing the remote again will return the adjustment to level 1 (least sensitive). Once you have adjusted the sensitivity level to the desired setting, turn the ignition on to exit this mode.</p>
Installer Mode	12	SELECT The Mode Required	<p>After pressing the remote 12 times to enter this mode, <u>turn the ignition to off</u>. This mode allows the installer / owner to verify that each trigger of the alarm system is working, without having to arm &amp; disarm the system each time &amp; set off the siren. The siren will beep and the blinkers will flash to indicate a trigger eg push the bonnet switch, open a door, hit the vehicle. The siren will beep four times to indicate a pre-warning impact sensor detection, or once to indicate full alarm trigger level. <u>Turn the ignition to on to exit this mode.</u></p>
PAT™ Past Alarm Trigger Memory	13	SELECT to replay memory	<p>After pressing the remote 13 times to enter this mode, turn the ignition off. Your Rhino Alarm offers a unique memory that stores the ten last reasons why the alarm was triggered. This memory cannot be erased.</p> <p>1 Beep, 1 Flash - Voltage Drop Alarm  2 Beep, 2 Flashes - Glass Break Alarm  3 Beep, 3 Flashes - Shock Sensor Alarm  4 Beep, 4 Flashes - Power Fail Alarm  5 Beep, 5 Flashes - Ignition Alarm  6 Beep, 6 Flashes - Aux Alarm  7 Beep, 7 Flashes - Door Alarms  8 Beep, 8 Flashes - Bonnet / Boot Alarm</p> <p>If two previous alarms were recorded i.e. voltage drop and shock sensor the LED will flash and the siren will beep once for voltage drop, then no noise for 1 second then beep three times for shock sensor. <b>The last memory heard is the most recent alarm sector triggered.</b> Turn the ignition to on to exit this mode.</p>
Current Sense Override	15	ON	<p>When this feature is on, the alarm will not trigger when a sudden change in battery current is sensed.</p> <p>NOTE: This will ONLY beeps out the state of this feature i.e. no other active features in the register will be beeped out. I.e. if this feature is NOT on, then NO beeps will be heard.</p>

Turbo Timer Run Time	16	OFF	This feature is used for setting the run time for both interface and onboard turbo timers. Refer to Turbo Timer Instructions.
Onboard Turbo Timer	17	OFF	When turned ON this feature activates the on-board turbo timer which allows the turbo timer to be shut down early via button 2. To set up the on board turbo timer, refer to Turbo Timer Instructions.
3 second Panic Delay / Instant Panic	18	ON	When this feature is ON button 3 needs to be held for 3 seconds to activate panic.
TransTX Upgrade Mode (Only required if the old style OEM enhancement is used)	19	OFF	When this feature is turned on then the Transformer module may be interfaced to allow the user to arm and disarm their vehicle via the factory remote control.  If this featured is turned on then a single beep will be produced. If this feature is turned off then no beeps will be heard.
Auto Immobilise Override	20	OFF	When this feature is turned ON the vehicle will not auto immobilise.
Wireless Keypad Mode	21	OFF	When this feature is turned on then the Wireless Keypad may be used to disarm the vehicle while still using the standard factory remotes to lock and unlock the vehicle. See the Wireless Keypad instructions for further details.  If this featured is turned on then a single beep will be produced. If this feature is turned off then no beeps will be heard.
Courier mode	22	OFF	When this feature is turned on then the Wireless Keypad may be used to disarm the vehicle while still using the standard factory remotes to lock and unlock the vehicle. See the Wireless Keypad instructions for further details.  If this featured is turned on then a single beep will be produced. If this feature is turned off then no beeps will be heard.

## How to Change REGISTER 2:

**Vehicle Set Up:** DRIVER'S DOOR OPEN, AND IGNITION ON → OFF → ON

**Remote Key action:** TURN ON / OFF FEATURES VIA THE  BUTTON ON THE REMOTE

FEATURE	Press Remote This Many Times	FACTORY SETTING	DESCRIPTION
LEFT Button Used To Arm/Disarm This Vehicle	2	OFF	This is activated if you have two cars with Rhino remote controls, the vehicle that this is feature is activated on will use the left button to arm disarm and lose the ability to activate the boot release output.
Impact Sensor	3	ON	Activate 2 Stage Impact sensor & glass break sensor.
Automatic Rearm & Relock	4	OFF	This feature prevents accidental system disarming & will relock the doors if a door is not opened within 60 seconds. See page 2 for full function description. If you activate this feature, dome light extension will be turned off automatically. <b>Installers must wire up the door circuit to function.</b>
Timed Negative on Arm (Headlight Timer – 15 sec)	5	OFF	When on, this feature changes the <b>-ARM</b> wire from being a <b>constant negative on arm</b> to a <b>timed 15 second negative on arm wire</b> . This will allow you to connect this wire via a relay (see diagram on page 15) to your headlight circuit, so that when you arm your immobiliser, your headlights will turn on for 15 seconds to illuminate your path, and then automatically switch off. (You can press the LEFT button on your remote to turn the lights off before the 15-second period). You can still connect window lift modules to this wire, as long as it takes no longer than 15 seconds to wind up the windows in the car.
Selectable Indicator Flash	6	ON	When off, this feature prevents the indicators from flashing when the system is triggered.
Extended Lock Pulse (Central Closure)	7	OFF	When on, the lock output becomes a 15 second negative pulse instead of 0.5 seconds. This feature is for certain vehicles with vacuum central locking or those with a central closure wire (some BMW, Mercedes) i.e. doors lock, electric windows wind up, sunroof closes automatically.
Extended Unlock Pulse	8	OFF	When on, the unlock output becomes a 15 second negative pulse instead of 0.5 seconds. This feature is for certain vehicles with vacuum central locking.

## Installation

### “RES2001” Insurance Requirements

Some Insurance Companies in Australia will now specify that they require a Rhino Model “RES2001” Immobiliser to be professionally fitted to their client’s vehicles before they will insure the vehicle for theft.

The code RES2001 has been especially given to insurance companies to make sure that their specified installation of a RAV3 is carried out to their client’s vehicles. If a customer says they need to have an RES2001 fitted this means that you must:

1. Be qualified to install an automotive security product, and if required hold the necessary security license (compulsory in NSW).
2. Install the Rhino JAGv2/RAv3 with 3 separate immobilisation points (i.e. starter, fuel, & ignition).
3. Provide your customer with an invoice stating that a “Rhino RES2001” has been installed.

### Installing the Main Control Unit

Mount under the dash, in a well-hidden location. Securely fix the main unit with cable ties or similar to prevent the unit from moving around. Failure to do this will result in poor shock sensor sensitivity, and may cause harm to the electronics.

### Internal Connector Diagram

In case you loose track of a wire, expose the main harness connector by unclipping the case. Use the connector diagram below to trace your wire & its function.

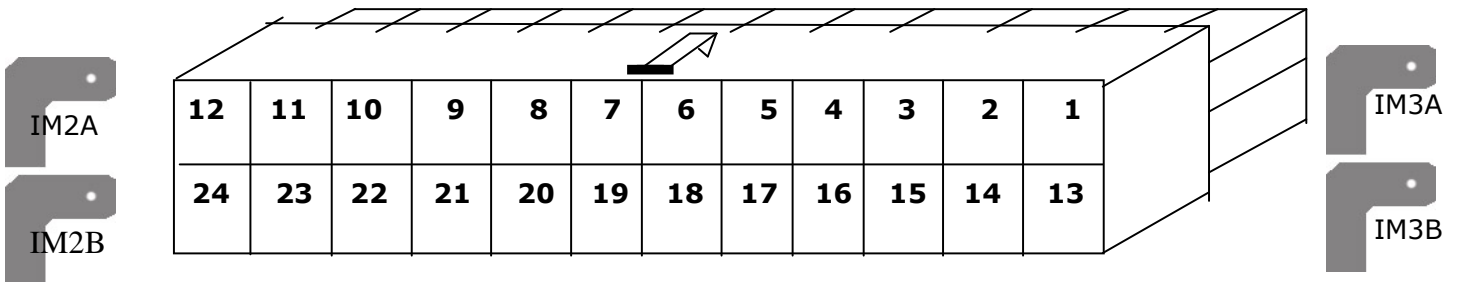

Pin	Connection	Pin	Connection
1	GND	13	IGN
2	Door	14	GND
3	IM1A	15	+ LED
4	IM1A	16	- Siren
5	IM1B	17	+ 12V
6	IM1B	18	- Arm
7	R - Blinker	19	Boot - Out
8	Lock NC	20	Hood - in/Trunk - in
9	Lock COM	21	- LED
10	Lock NO	22	AUX
11	Unlock NC	23	L - Blinker
12	Unlock COM	24	Unlock NO

**Important!** This connector is electrically compatible ONLY with the RAV3 and previous RAV2 and JAG alarm system - Even though the JAGv2/RAv3 plug looks the same as connectors used in earlier Rhino RES4601 and RA models, THEY ARE NOT COMPATIBLE.

## Factory Remote Interface

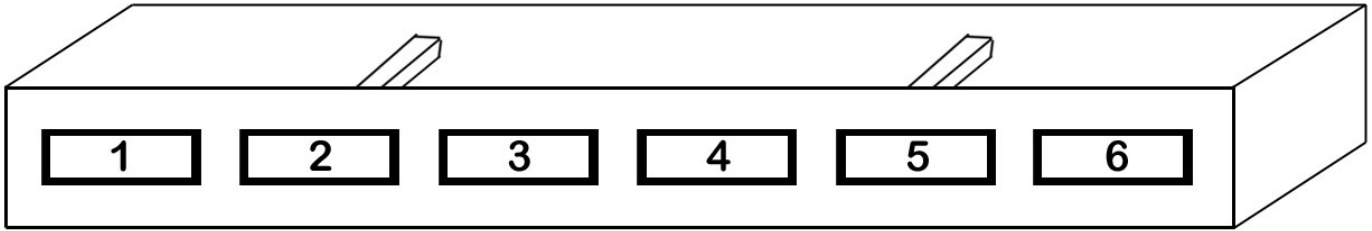

Pin	Connection
1	M1
2	M2
3	POS1
4	POS2
5	NEG1
6	NEG2

### Modes of Operation:

#### ***Inhibit mode (Register 1 Feature 10):***

In inhibit mode the alarm will be armed and disarmed by M1/M2 and POS1/POS2. If a negative signal is detected by NEG1 or NEG2 arming or disarming will be inhibited. NEG1 and NEG2 would normally be hooked up to the negative switch wires from the door or a lock/unlock switch in the car. The important thing to remember is that the alarm should only arm and disarm from the factory remote, not from the key in the door or a switch on the dash.

Wire	Inhibit mode
POS1	Positive disarm: disarms when wire gets a positive pulse
POS2	Positive arm: arm on positive pulse
NEG1	Negative inhibit: stops arm/disarm (disables other wires for short period)
NEG2	Negative inhibit: stops arm/disarm (disables other wires for short period)
M1	Positive disarm: generally boot
M2	Positive arm: positive input will arm the alarm

**Enable mode (Register 1, Feature 10):**

In enable mode the POS1 wire must see a positive signal to enable the system to arm or disarm. This is often hooked up to the indicators if they flash on arming or disarming.

Wire	Enable mode
POS1	Positive arm
POS2	Positive enable: this wire must go positive, or stay positive to arm/disarm alarm
NEG1	Negative arm
NEG2	Negative disarm
M1	Positive disarm
M2	Disarm: doesn't require enable wire to disarm. Need to see any change of state. Eg: Positive, Negative 0v to Positive/Negative

**Learn Mode (Register 1, Feature 9):**

Learn mode allows the system to learn the change of state on wires POS1, POS2, NEG1, NEG2 and M1, M2 to allow the car to control the locking and unlocking. Normally you do not need to use this mode as hooking up the above wires according to the data sheet for the specific vehicle will allow the alarm to work without changing any programming. If you don't have a data sheet and cannot get upgrade mode working correctly, learn mode can be activated to teach the alarm system the vehicles lock, unlock and boot release signals.

Follow this procedure to enter and program learn mode:

1. Close the bonnet (hood) and boot (trunk) and sit in the vehicle with the doors closed.
2. Lock the doors with the factory remote.
3. Disarm the immobiliser and turn the ignition on.
4. Push the left button on the remote 9 times.
5. Turn the ignition off. The siren will chirp to indicate it has entered learn mode.
6. Within one second unlock the car with factory remotes. One chirp will be heard,
7. Wait for LED to stop flashing then immediately lock the car with the factory remote,
8. One chirp will be heard, wait for the LED to stop flashing then, if applicable, activate boot, 5 chirps will be heard. If no boot, wait for the 5 chirps/flashes. The alarm will now arm/disarm from the factory remote.

Note: The chirp confirms learn, the LED flash between learns is to stop any other changes from being learnt i.e. if you lock the car, it learns the pulses that started the lock, but, must ignore the pulse when it 'stops locking'.

## Turbo timer instructions



The system has two turbo timer features. Firstly it has an interface compatible with external turbo timers, and secondly it has its own on-board turbo timer system.

### Interface with external turbo timers

When this feature is turned ON, the system allows the vehicle to run on an external turbo timer for a time that does not exceed the time programmed into the system. The system allows for 1 minute, 2 minutes and 4 minutes.

IT IS VERY IMPORTANT THAT THE EXTERNAL TURBO TIMER DOES NOT RUN FOR LONGER THAN THIS TIME AS IT WILL CAUSE THE SYSTEM TO FALSE ALARM.

### How to set up the turbo timer feature and set the maximum run time:

1. Install the alarm as normal except connect the IGN input from the alarm to the vehicles accessory circuit instead of true ignition. This wire must drop to 0v when the key is turned off and the vehicle is running on the turbo timer.
2. Ensure all doors, bonnet and boot are closed.
3. Turn the ignition on and press , 16 times. The indicators, LED and siren will flash or chirp upon each press of the button.
4. Now turn the ignition off. The siren should produce a single chirp to indicate that the programming mode has been entered.
5. Pressing  will increment the maximum run time allowed for the turbo timer. There are four levels; each level is indicated by the number of chirps. See table below. It is very important that the external turbo timer does not run for longer than the maximum run time set below as the system will false alarm.



Number of chirps	Turbo timer run time
1	1 minute
2	2 minutes
3	4 minutes
4	10 secs

6. Once the desired time duration is selected simply turn the ignition on then off. The turbo timer time duration is now programmed in.

No other programming is required to run an external turbo timer. However, when using an external turbo timer ensure that the Onboard Turbo Timer feature in Register 1 is turned off (factory set off). Once the maximum time is programmed, the car's ignition may be controlled by an external turbo timer. The external turbo timer must not run longer than the time set above or the system will false alarm.

### Operation:

To operate the system simply turn the ignition off and exit the vehicle as normal.

Pressing /  will arm the alarm and lock the doors as normal but the immobiliser relays will stay closed until the pre-programmed time out.

If the alarm detects an intrusion the alarm will sound and the system will immobilise the engine.



## On-board turbo timer

On most vehicles the JAGv2/RAv3 can be set up to run the on-board turbo timer by simply connecting the ignition immobiliser wires that would normally be connected to the key side of the cut (IM2A) to +12V main power feed as shown in the diagram below. The IGN sense wire remains on the key side of the ignition wire while the remaining immobiliser wires (IM2B) are connected to the engine side of the ignition wire. Many vehicles have dual ignition wires to run cooling fans. You must ensure the cooling fans continue to run when the vehicle is running on the turbo timer. Note: IM2A MUST BE CONNECTED TO +12V MAIN POWER FEED.

Wiring instructions:

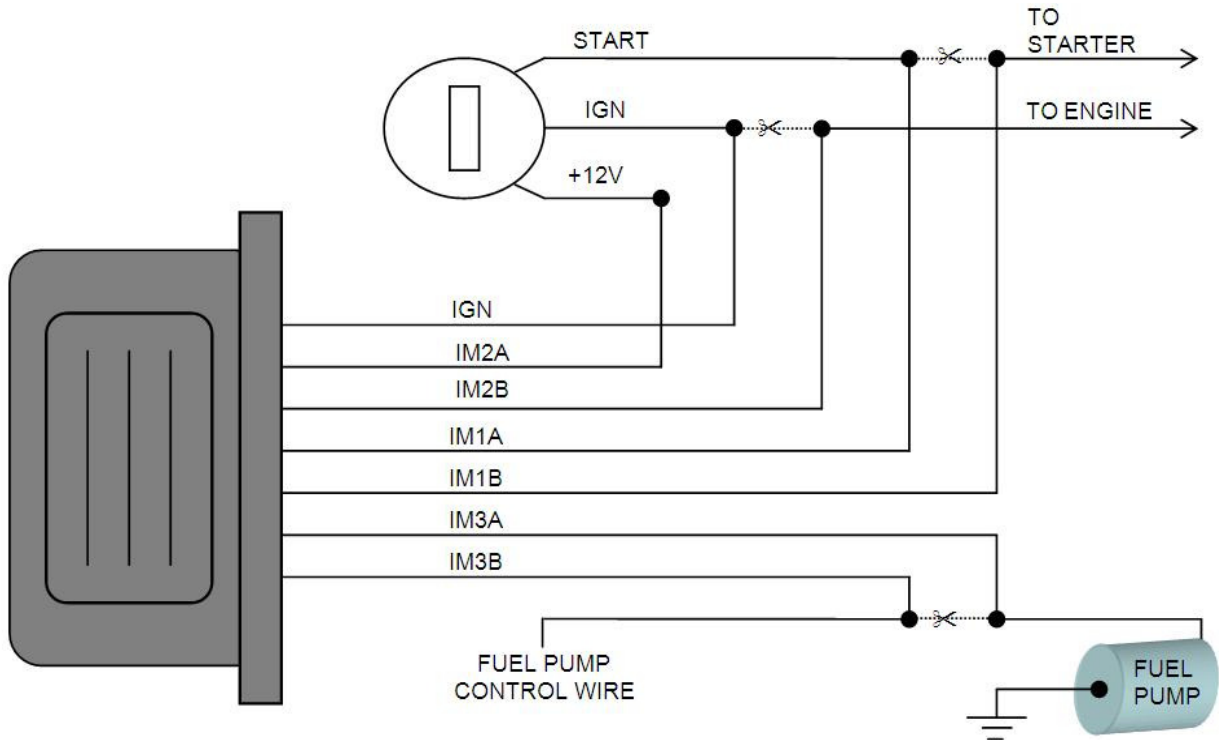

How to set up the on-board turbo timer:

1. Install the alarm as normal except connect the ignition immobilisers and IGN input to the alarm as shown in the diagram.
2. Set the run time as per instructions on the previous page (Register 1, Feature 16)

To allow  shutting down the engine before the turbo timer times out:

1. Turn off the ignition.
2. Open the doors and bonnet and then turn the ignition on.
3. Press , 17 times.
4. Turn the ignition off. This will toggle the feature on or off. If the on-board turbo timer feature is turned on the siren will chirp once. If the feature is turned off the siren will not chirp.

### Operation:

To operate the system, simply turn the ignition off and exit the vehicle as normal. The engine will continue to run for the preset max run time.

Pressing  will arm the alarm and lock the doors as normal but the immobiliser relays will stay closed until the pre-programmed time out. If the alarm detects an intrusion the alarm will sound and the system will immobilise the engine.

If the vehicle is running on the on-board turbo timer (and the alarm is disarmed) it is possible to turn the ignition back on and drive the vehicle.

## WIRING INFORMATION

Wire Number	CONNECTION
12	<b>Unlock COM</b> – Polyfused 3A unlock relay common. Refer to diagrams contained later in this manual for central locking connection
1 and 14 (2 Wires)	<b>GND</b> Connect to a suitable earth on the car body.
17, 15 & +LED (3 Wires)	<b>12V</b> Connect to constant +12 volts via the fuse box or from behind the ignition keybarrel. The negative side of the dash warning LED is already connected in the wiring harness, however the wire marked +LED must be connected to constant +12V.
16	<b>Siren</b> Connect this wire to the siren output wire from your siren. Note: You can only connect to specially coded Rhino sirens (BBSC). This output is not compatible with any other brand of siren as coded data is transmitted to turn the siren on and off.
18	- <b>ARM “Negative on Arm Output”</b> . When the system is armed, this wire outputs a negative (-ve 150MA). Connect to the trigger wire on optional Rhino GLU400 electric window lift module. Can also be programmed to become a <b>timed 15 second negative on arm wire</b> . This will allow you to connect this wire via a relay (see diagram on page 4) to your headlight circuit, so that when you arm your immobiliser, your headlights will turn on for 15 seconds to illuminate your path, and then automatically switch off. (You can press the LEFT button on your remote to turn the lights off before the 15-second period). You can still connect window lift modules to this wire, as long as it takes no longer than 15 seconds to wind up the windows in the car. <b>“Negative on alarm”</b> output must be taken from the BBSC siren.
19	<b>BOOT- OUT</b> This is the negative output for boot (trunk) release (150ma maximum). Optional for use where electric boot (trunk) release is to be connected. 40A Changeover Relay required. See connection diagram for detail.
20	<b>HOOD – IN/TRUNK - IN</b> - Connect to Bonnet switch/Boot switch
21	- <b>LED</b> - This wire is already connected from the wiring harness to the negative side of the dash LED.
22	<b>AUX</b> This is a <b>“Negative Trigger Input”</b> , and can be connected to the output circuit wire on any optional alarm accessory to be used. i.e. ultrasonic or microwave sensors.
7 and 23	<b>Blinker</b> - Connect to the left and right indicator (blinker) circuits of the vehicle to flash the indicators. Each circuit can supply a maximum 4A
24	<b>Unlock NO</b> - Unlock relay normally open terminal. Refer to diagrams contained later in this manual for central locking connection
2	- <b>DOOR</b> - Connect to existing door switch circuit. ( <b>Please note:</b> only negative switching doors, if doors are positive switching, relays must be used to reverse to negative - see diagram contained later in this manual)
IM1A 3 & 4 (2 Wires) & IM1B 5 & 6 (2 Wires)	<b>Immobilisation Circuits.</b> The starter wire is usually located under the steering column of the vehicle. <b>This wire must be +12 Volts only when the vehicle is being started.</b> Cut this wire. The vehicle should not start. Solder the starter motor side to both wires marked IM1B. Solder the other end to both wires marked IM1A. Repeat the above configuration for the electric fuel pump with wires IM2A & IM2B.
IM2A (2 Wires) & IM2B (2 Wires)	Repeat the above configuration for your third immobilisation circuit with wires IM3A & IM3B.
IM3A (2 Wires) & IM3B (2 Wires)	<b>NOTE:</b> For safety purposes, under no circumstances should you cut the vehicle’s main ignition system. To confirm that you haven’t cut the ignition wire: while the system is armed, make sure that your dash warning lights still come on (illuminate) when you turn the ignition to the ON position.
8	<b>Lock NC</b> - Lock relay normally open terminal. Refer to diagrams contained later in this manual for central locking connection
9	<b>Lock COM</b> - Polyfused 3A lock relay common. Refer to diagrams contained later in this manual for central locking connection.
10	<b>Lock NO</b> - Lock relay normally open terminal. Refer to diagrams contained later in this manual for central locking connection
11	<b>Unlock NC</b> - Unlock relay normally closed terminal. Refer to diagrams contained later in this manual for central locking connection
13	<b>IGN</b> Connect to a <b>+12 volts ignition switched lead</b> , which <b>does not fall to 0 volts when the engine is cranked.</b>

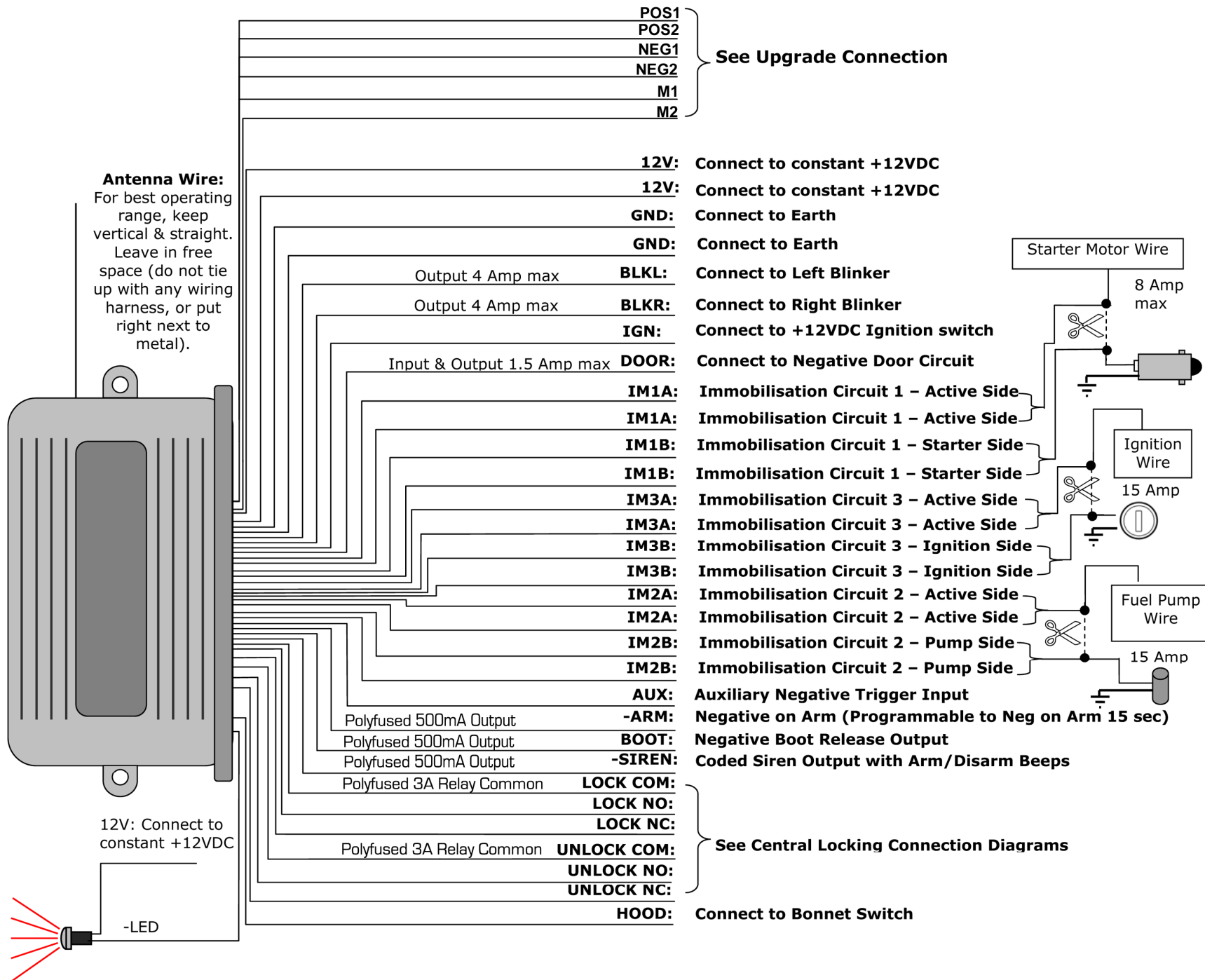

## Installing the Coded Battery Backup Siren (BBSC / MiniBBSC) - RAv3 Included:

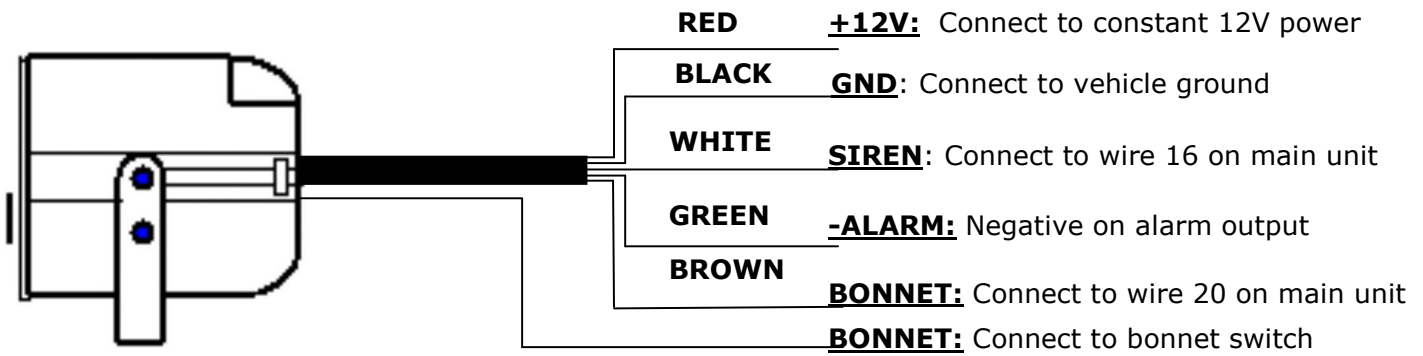

### Red - 12V Siren Power:

Connect to permanent 12v power source – a spare GND wire is available from the main alarm loom to assist ease of wiring.

### Black – Siren Ground:

Connect to an earth point on vehicle chassis – a spare GND wire is available from the main alarm loom to assist ease of wiring.

### White – Siren Data Input:

Connect to wire 16 “-SIREN” on the main alarm loom. Multiple data sirens can be connected to a single alarm system with the white data wires joined in parallel.

### Green – Negative on Alarm Output:

Gives a constant 200mA negative output (-alarm) when the alarm is triggered. This can be used to run an additional piezoelectric siren directly or activate a larger siren / vehicle horn through an external relay.

### Brown & separated black – Bonnet Wires:

These two wires are looped together inside the siren and are used to assist in wiring the bonnet pin switch without needing to extend the standard loom. Wire 20 from the main alarm loom should be wired to the brown wire, and the pin switch should be wired to the separated black wire.

## Installing Additional Sirens (non-coded)

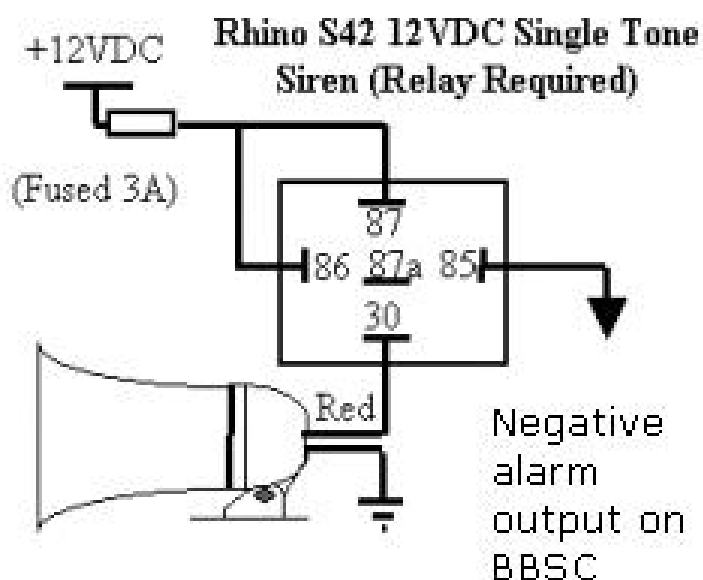

### Rhino DPS High Frequency Cabin Piezo Siren

Negative alarm output on BBSC

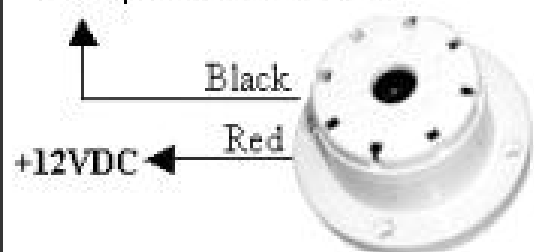

## Installing Timed Headlight Delay

Note: A 40 Amp Changeover Relay is required.

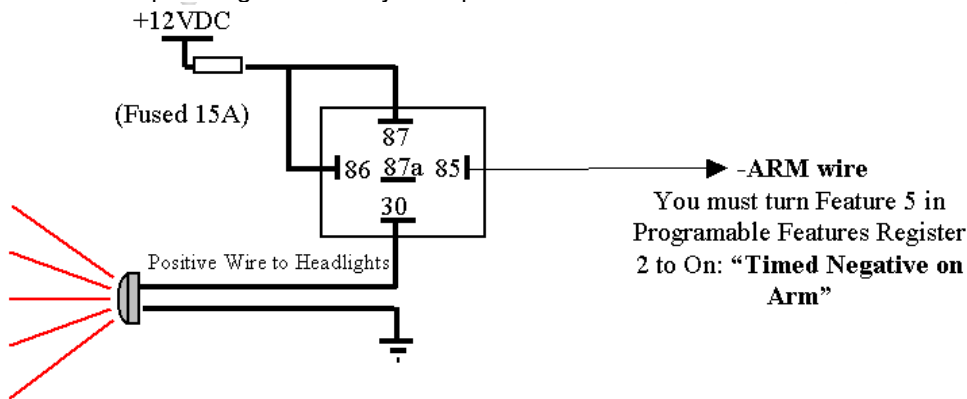

## Connecting to an Existing Electric Boot (Trunk) Release Motor

Note: A 40 Amp Changeover Relay is required.

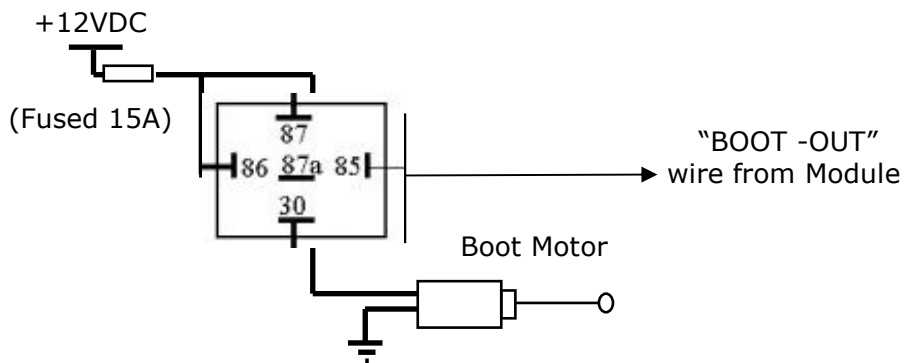

## Connecting the Vehicle's Door Switch to the Immobiliser:

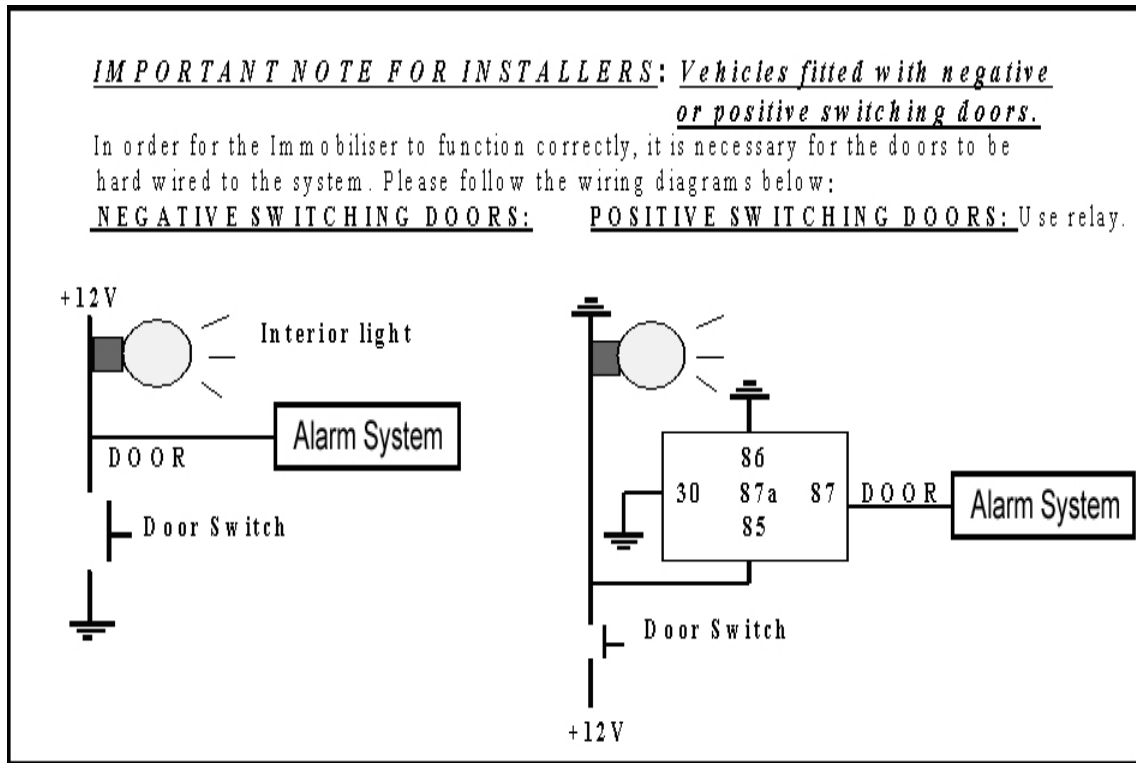

## VEHICLES FITTED WITH AN INTERIOR LIGHT DELAY

### IMPORTANT NOTE:

Vehicles fitted with an interior light delay require a diode to be added to prevent the system giving a door ajar warning.

Please follow the wiring diagram below:

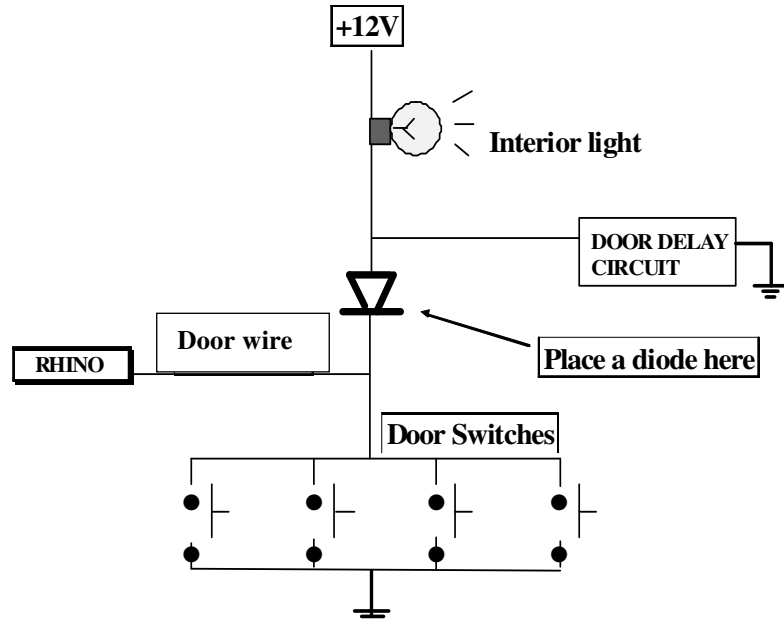

# Central Door Lock Diagrams

## 1. Negative pulse CDL system:

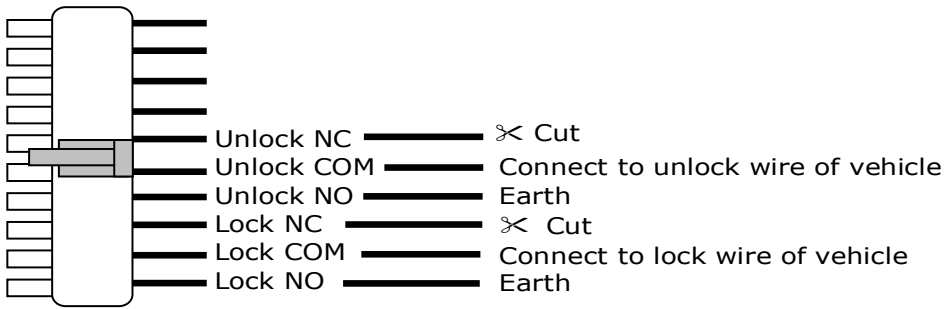

## 2. Positive pulse CDL system:

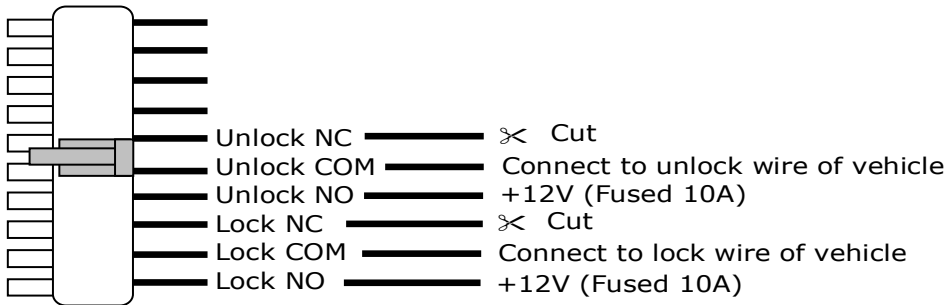

## 3. Reverse Polarity CDL system:

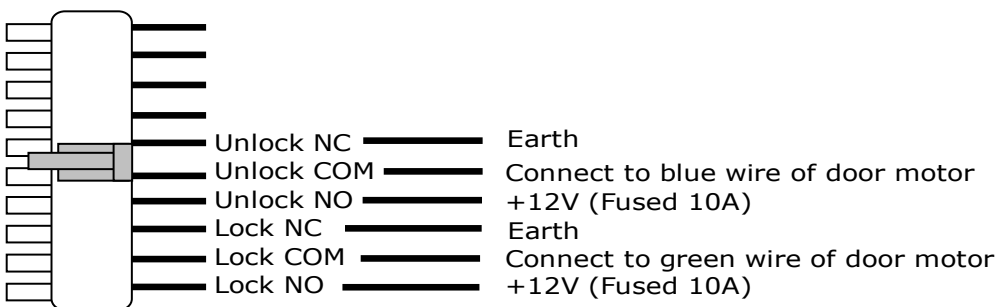

## 4. Vacuum CDL system:

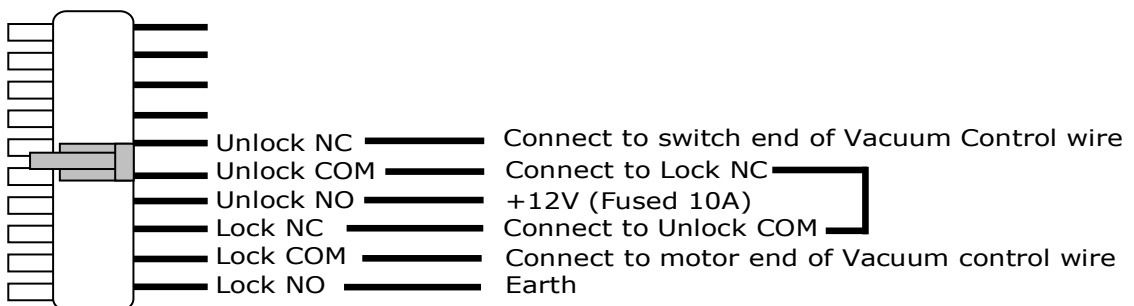





## WARRANTY TERMS & CONDITIONS

RhinoCo Technology (The Company) warrants its products to be in conformance with its own plans and specifications and to be free from defects in materials and workmanship under normal use and service for 12 months from the date stamp control on the product, or for products not having a date stamp, for twelve months from the date of original purchase unless the installation instructions or catalogue sets forth a shorter period, in which case the shorter period shall apply. The Company's obligation shall be limited to repairing or replacing, at its option, free of charge for materials or labor, any part which is proved not in compliance with The Company's specifications or proves defective in materials or workmanship under normal use and service. The Company shall have no obligation under this Limited Warranty or otherwise if the product is altered or improperly repaired or serviced by anyone other than The Company.

For Back-to-Base warranty service, return transportation prepaid, please send the alarm to RhinoCo Technology, 9 Hannabus Place McGraths Hill NSW 2756 Australia.

There are no warranties, expressed or implied, of merchant ability, or fitness for a particular purpose or otherwise, which extend beyond the description on the face hereof. In no case shall The Company be liable to anyone for any consequential or incidental damages for breach of this or any other warranty, express or implied, or upon any other basis of liability whatsoever, even the loss or damage is caused by its own negligence or fault.

The Company does not represent that the products it sells may not be compromised or circumvented; that the products will prevent any personal injury or property loss by burglary, robbery, fire or otherwise; or that the products will in all cases provide adequate warning or protection. Customer understands that a properly installed and maintained alarm system may only reduce the risk of a burglary, robbery, or fire without warning, but it is not insurance or a guarantee that such will not occur or that there will be no personal injury or property loss as a result.

Consequently, The Company shall have no liability for any personal injury; property damage or other loss based on a claim the product failed to give any warning. However, if The Company is held liable, whether directly or indirectly, for any loss or damage arising under this limited warranty or otherwise, regard less of cause or origin, The Company's maximum liability shall not in any case exceed the purchase price of the product, which shall be the complete and exclusive remedy against The Company.

This warranty replaces any previous warranties and is the only warranty made by The Company on this product. No increase or alteration, written or verbal, of the obligations of this Limited Warranty is authorised.

