

Applicable Model

X916

Drawing Title

Intercom Panel

Drawing Unit

mm

Drawing Scale

Not to scale

**DRAFT
SUBJECT TO
CHANGE**

Last Revised

December 31,2019

Drawing Version

V1.0

Page

1 of 5

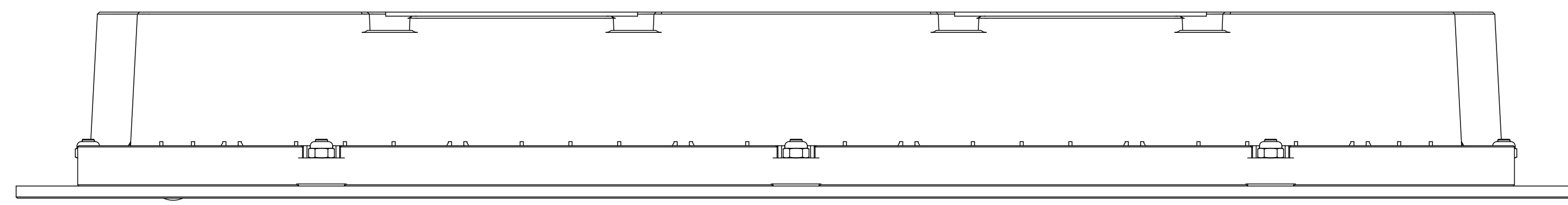

5 TOP VIEW

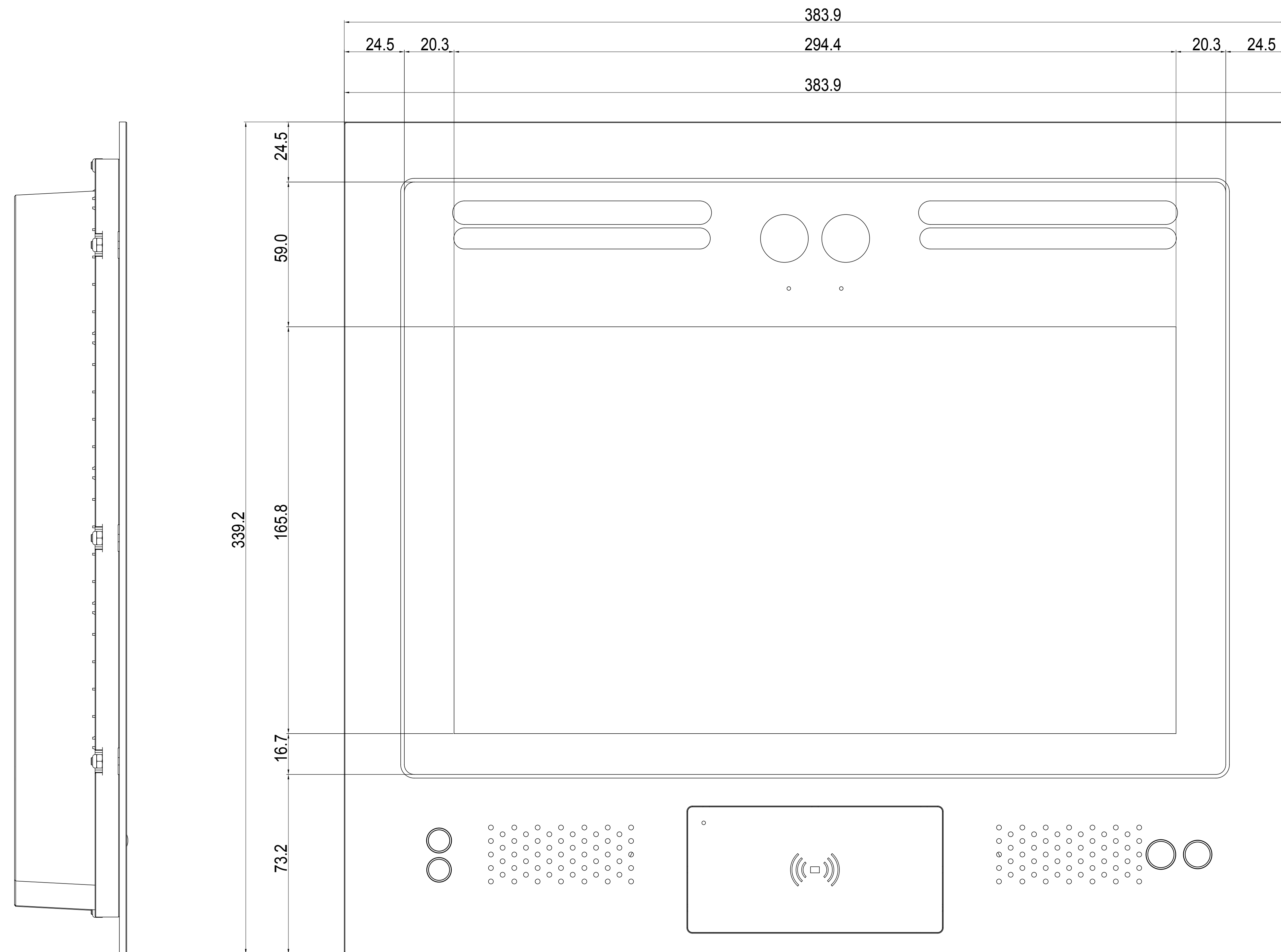

1 FRONT VIEW

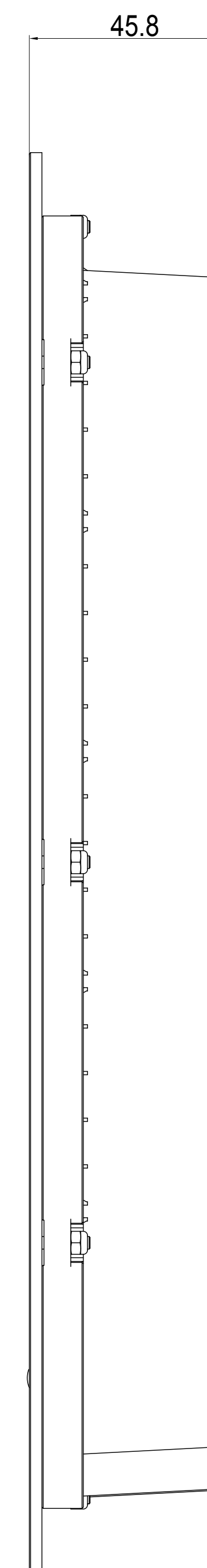

3 LEFT VIEW

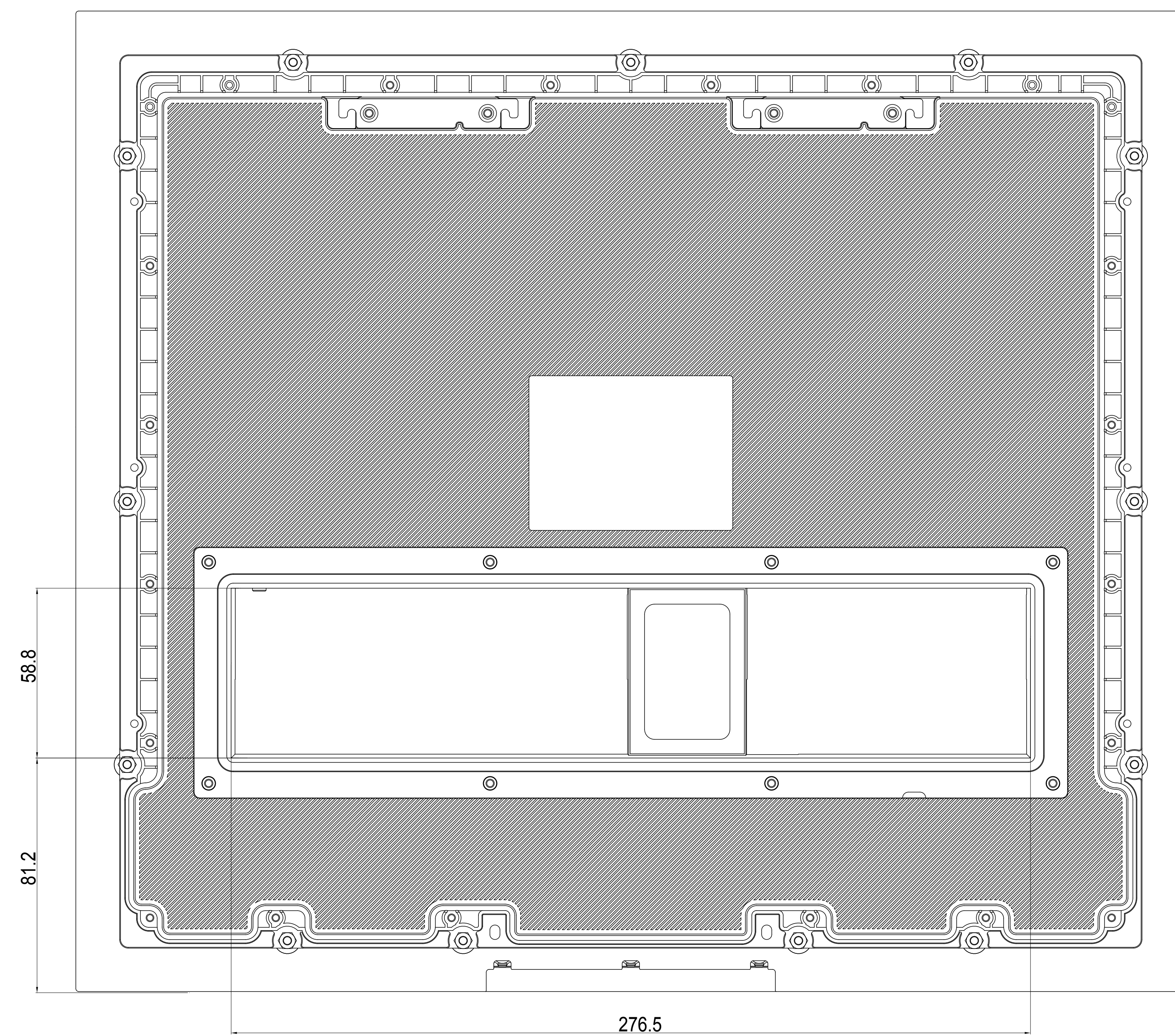

4 BACK VIEW

2 RIGHT VIEW

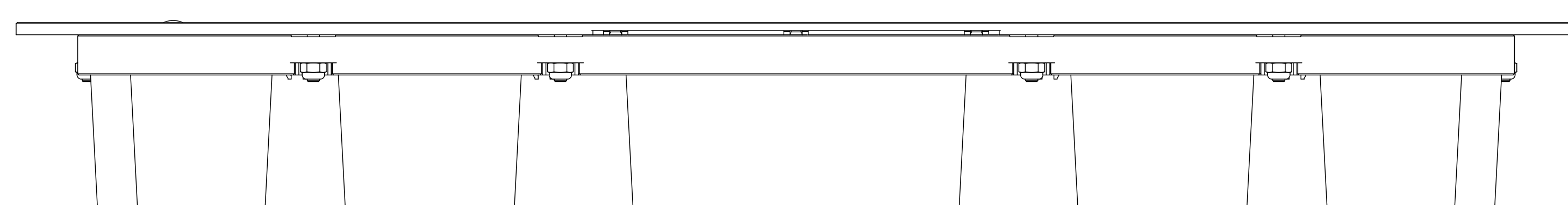

6 BOTTOM VIEW

Applicable Model

X916

Drawing Title

Flush Mounting Box

Drawing Unit

mm

Drawing Scale

Not to scale

**DRAFT
SUBJECT TO
CHANGE**

Last Revised

December 31,2019

Drawing Version

V1.0

Page

2 of 5

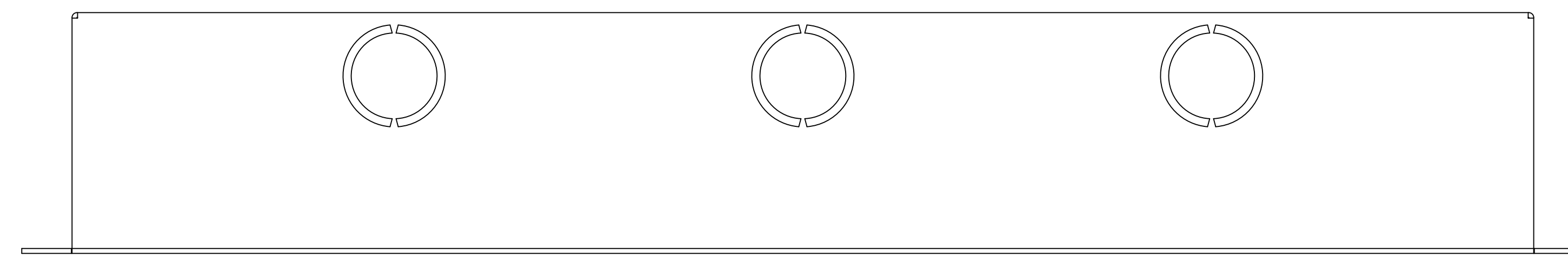

5 TOP VIEW

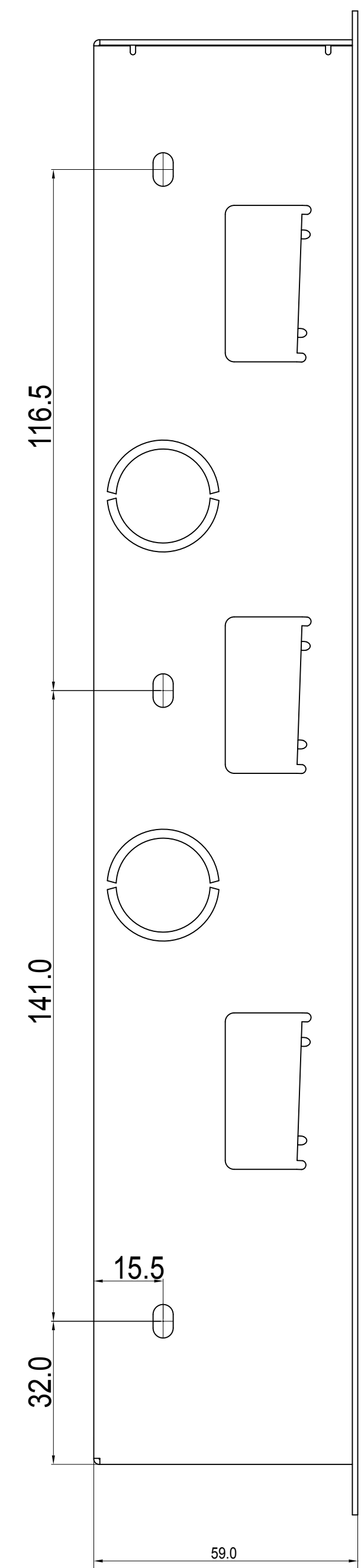

2 RIGHT VIEW

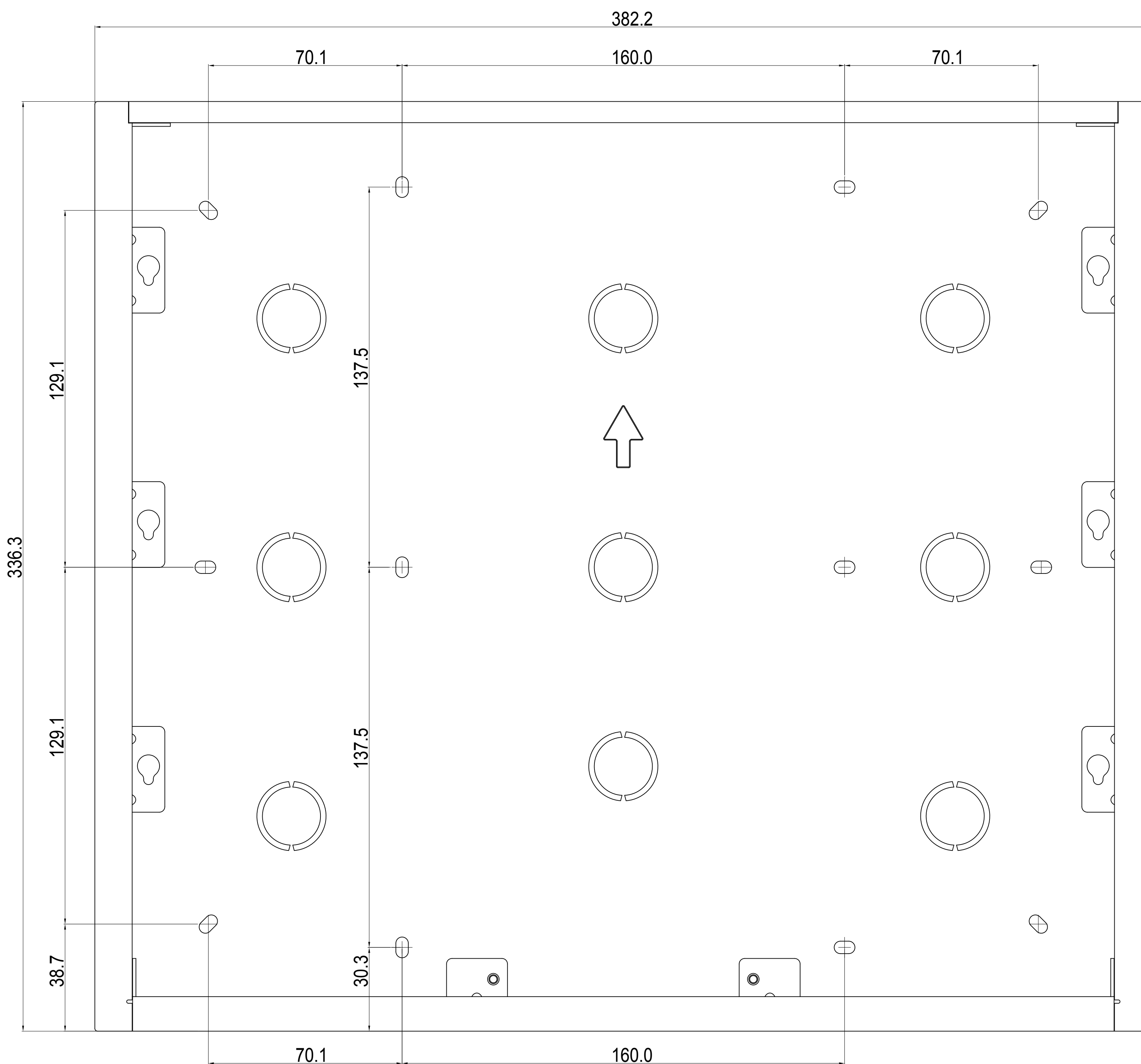

1 FRONT VIEW

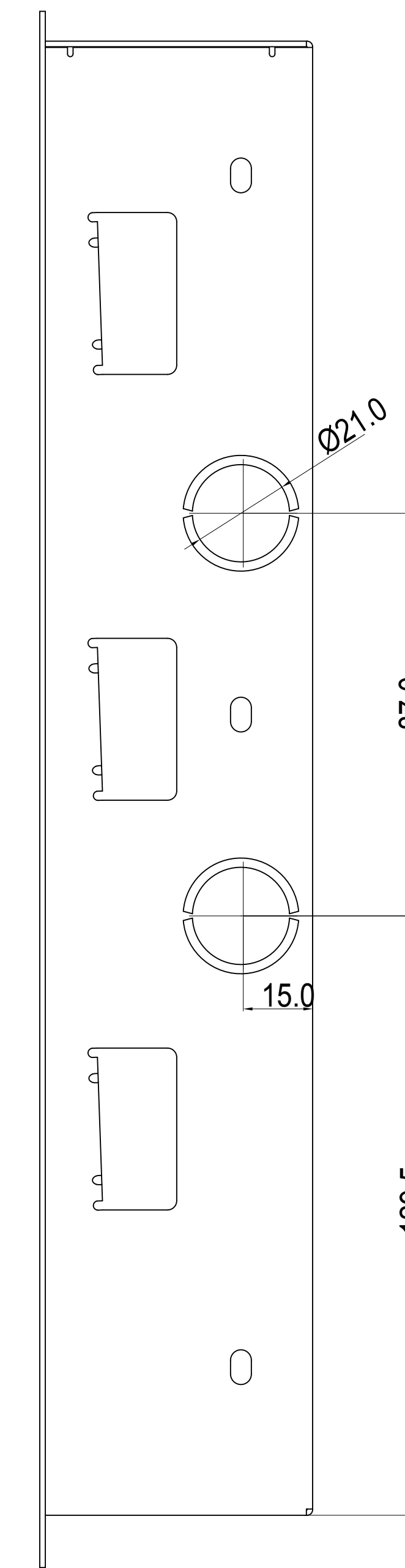

3 LEFT VIEW

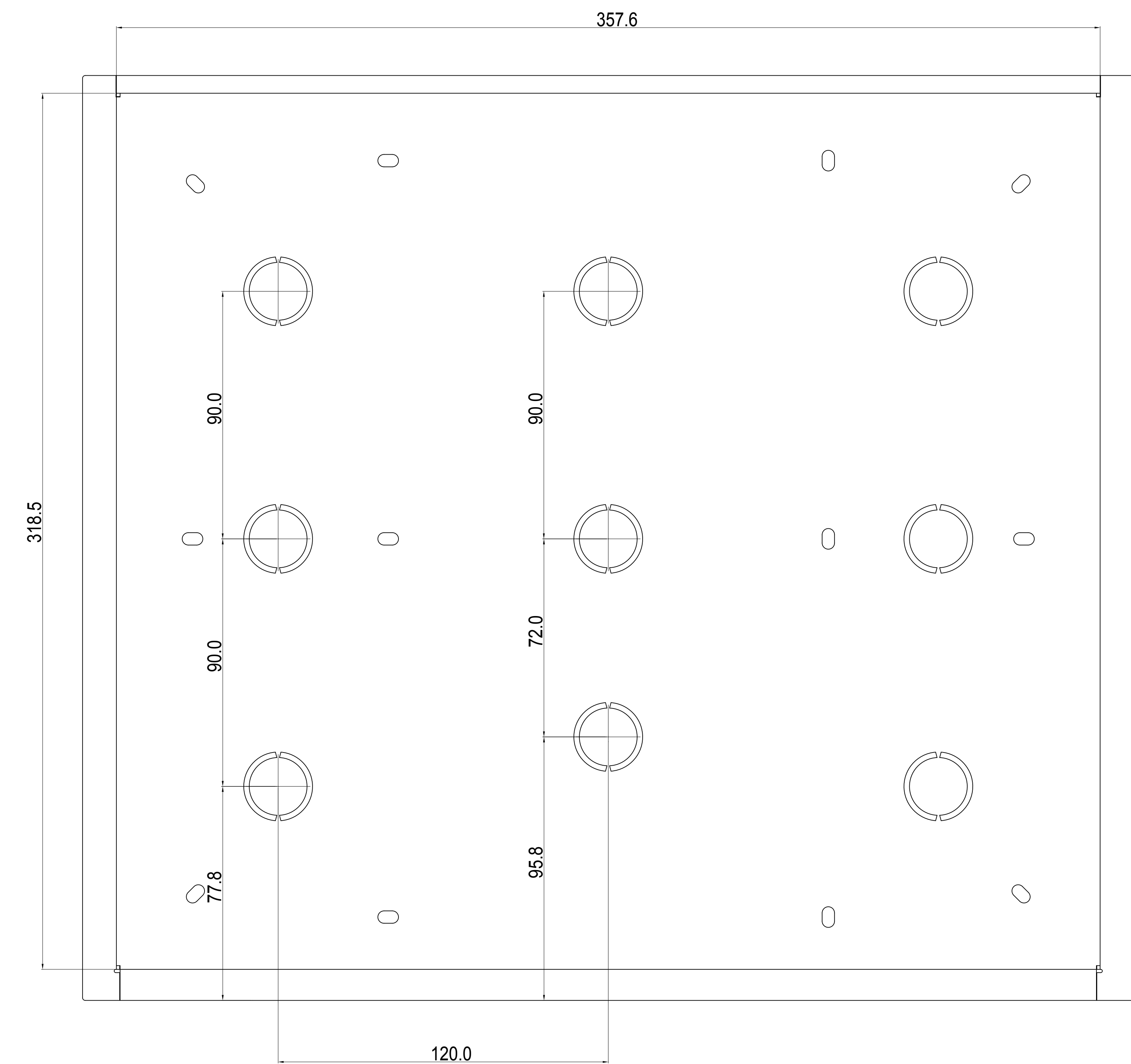

4 BACK VIEW

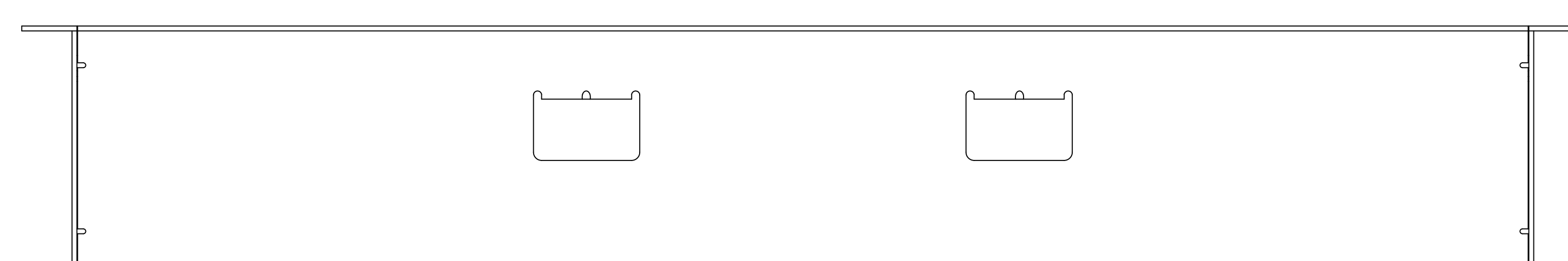

6 BOTTOM VIEW

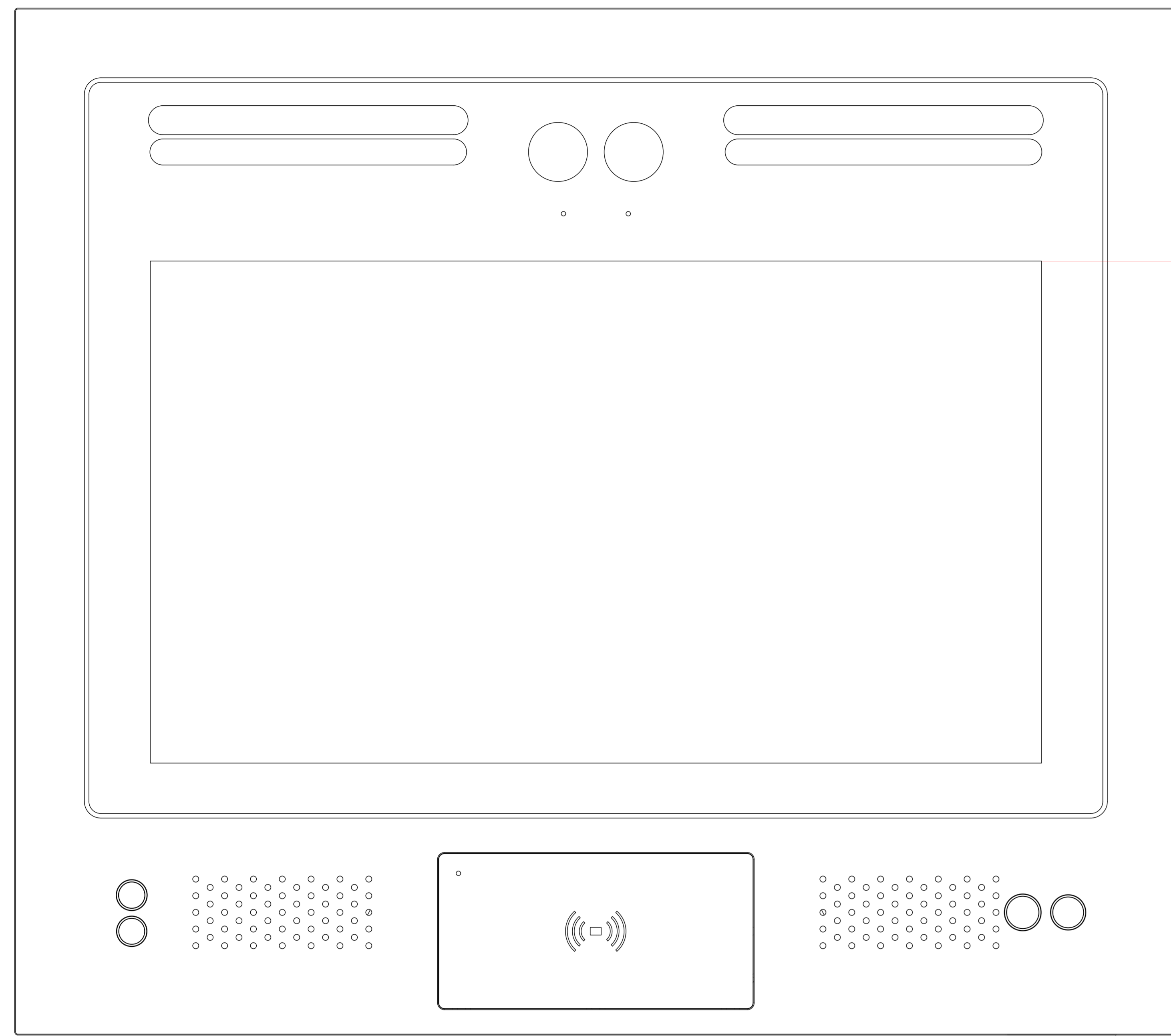

1 INTERCOM PANEL FRONT VIEW

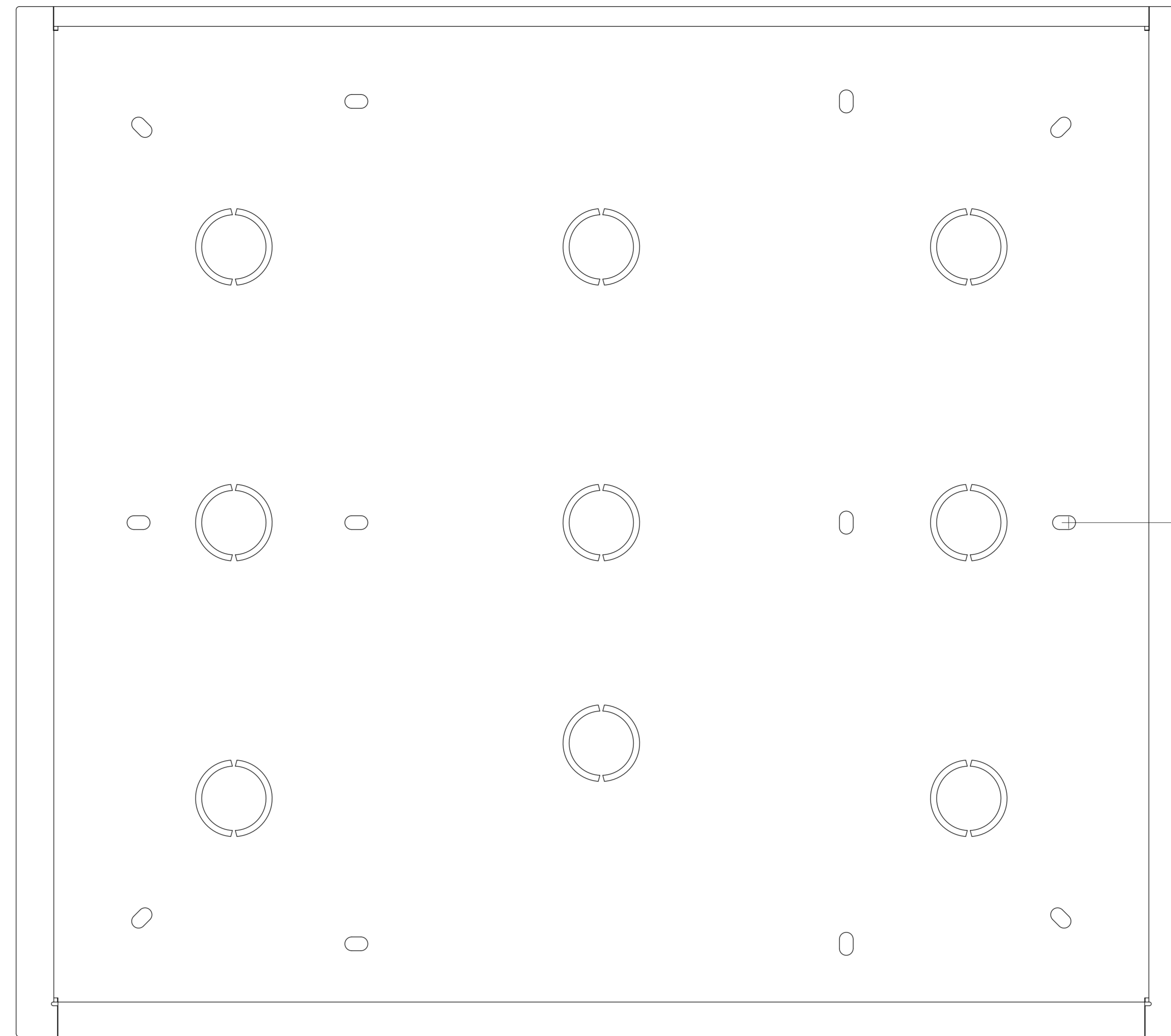

2 FRONT VIEW: FLUSHING MOUNTING BOX PLACEMENT

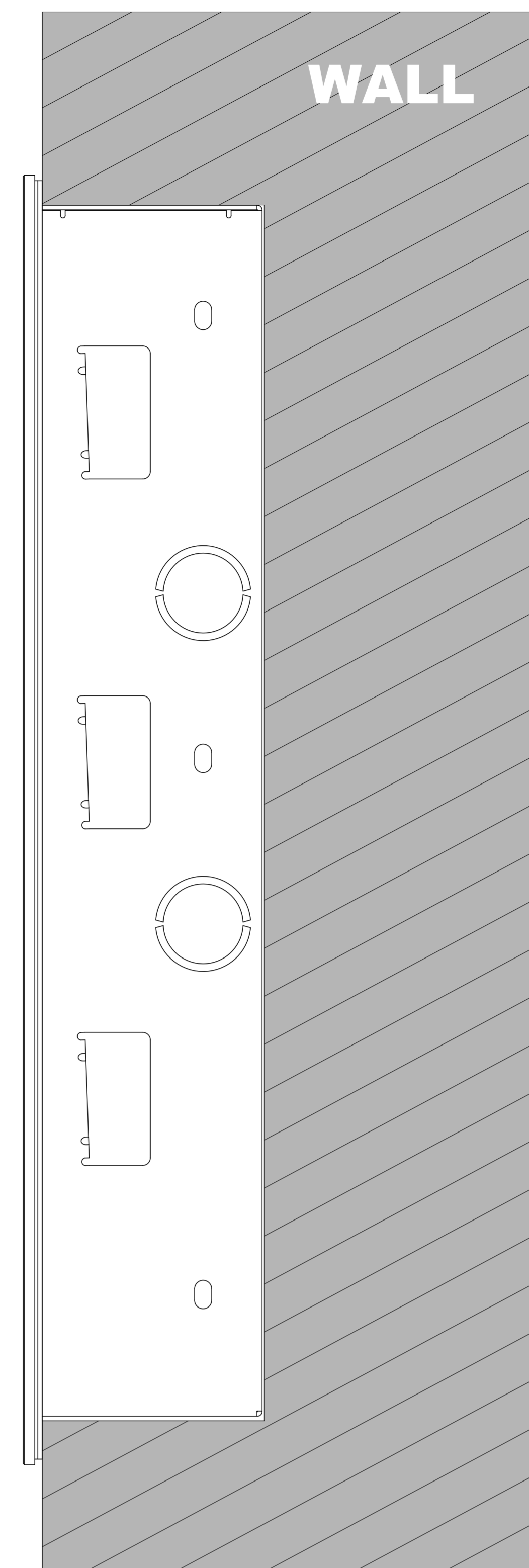

3 SIDE VIEW:INTERCOM IN WALL

994.4mm TO BOTTOM OF PANEL

1200mm MAX TO TOP OF USABLE TOUCHSCREEN

ADA Compliance Requirement

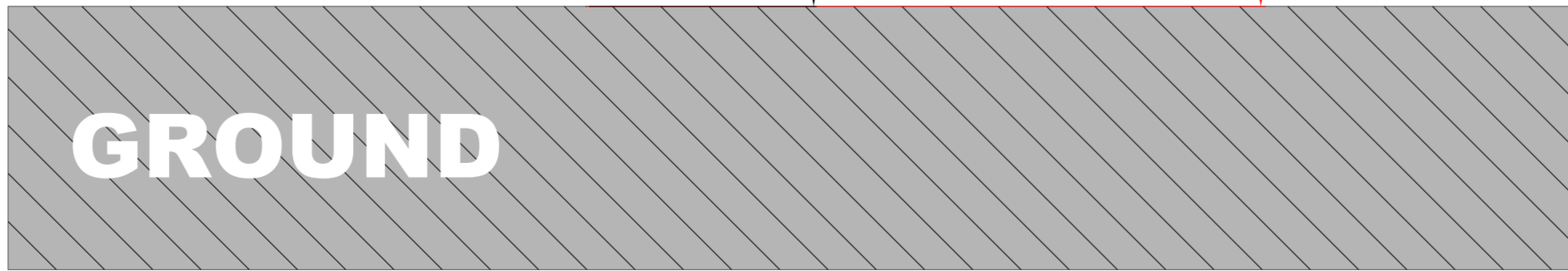

GROUND

945.8mm TO BOTTOM OF BRACKET

1113.6mm TO SCREW HOLE CENTER OF BRACKET

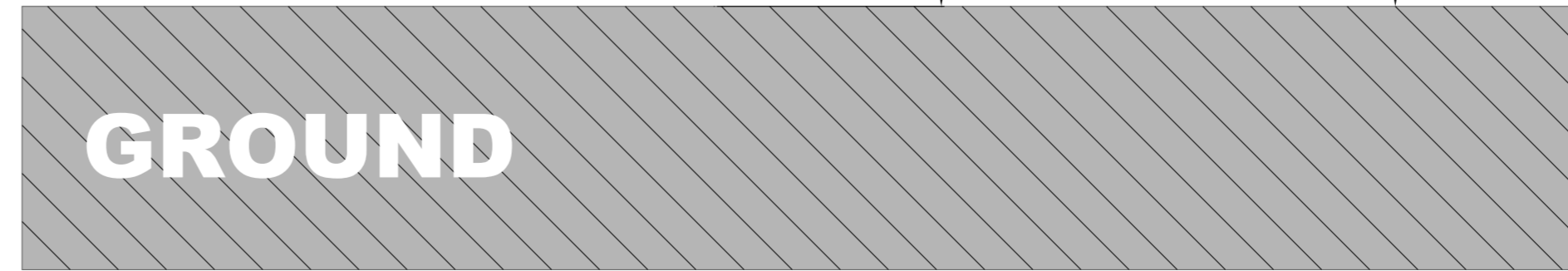

GROUND

Applicable Model

X916

Drawing Title

Wall Mounting Box

Drawing Unit

mm

Drawing Scale

Not to scale

**DRAFT
SUBJECT TO
CHANGE**

Last Revised

December 31,2019

Drawing Version

V1.0

Page

4 of 5

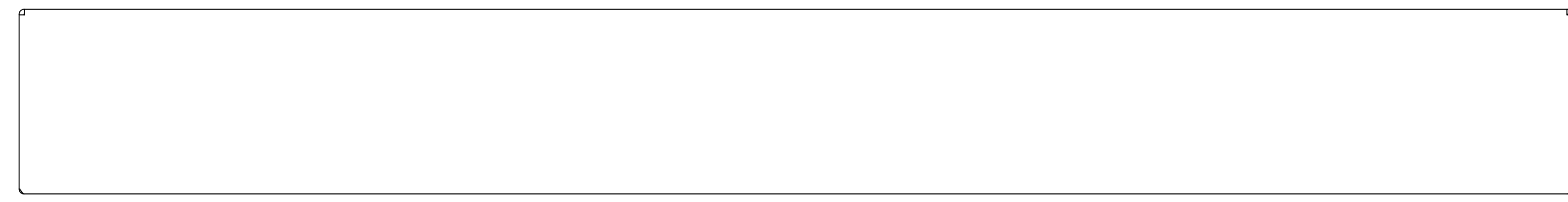

5 TOP VIEW

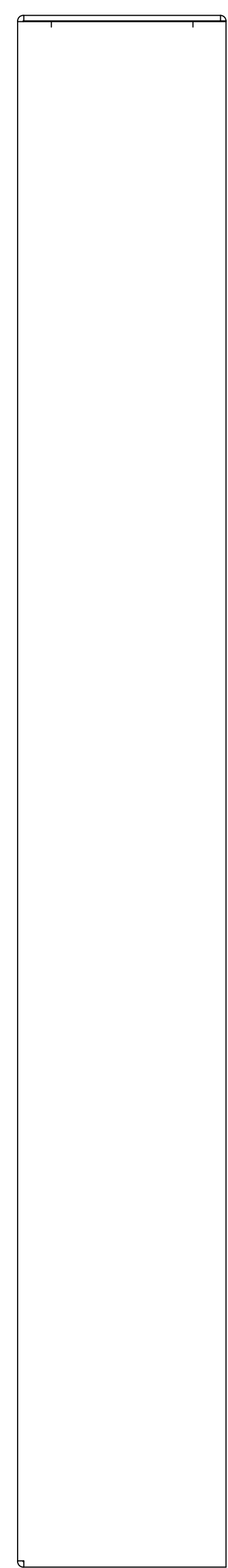

2 RIGHT VIEW

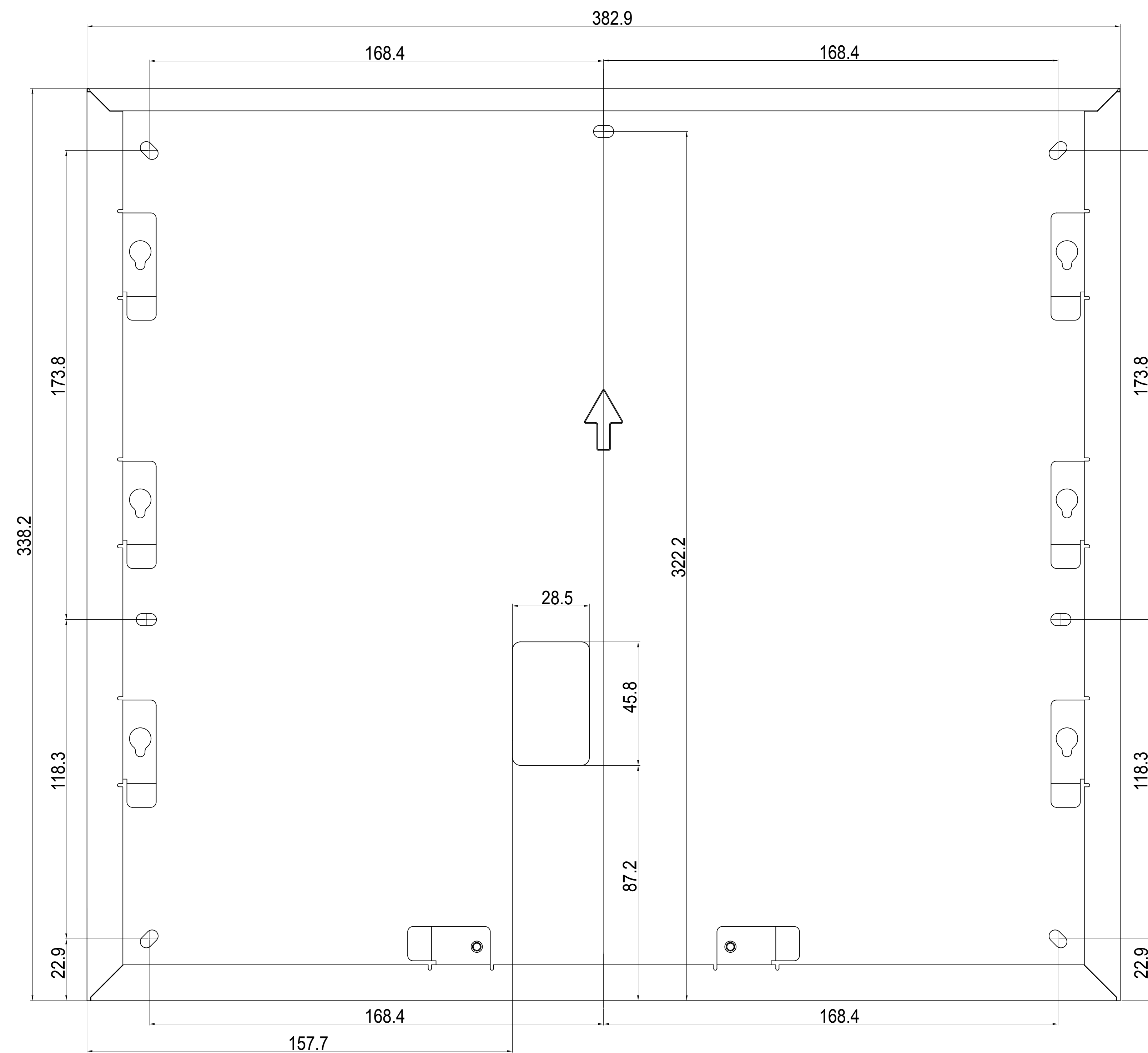

1 FRONT VIEW

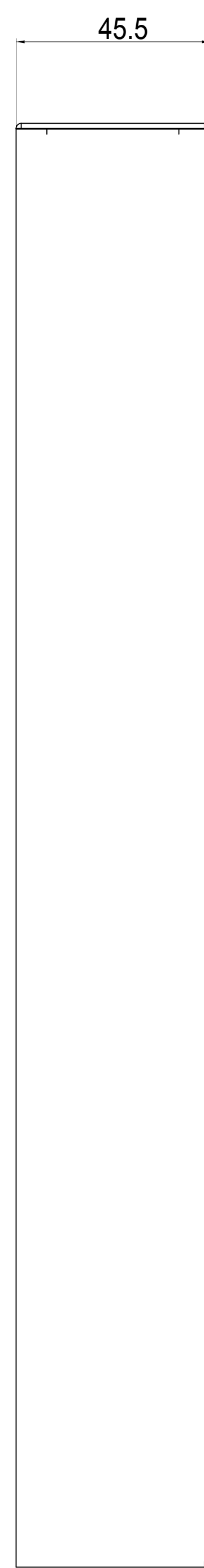

3 LEFT VIEW

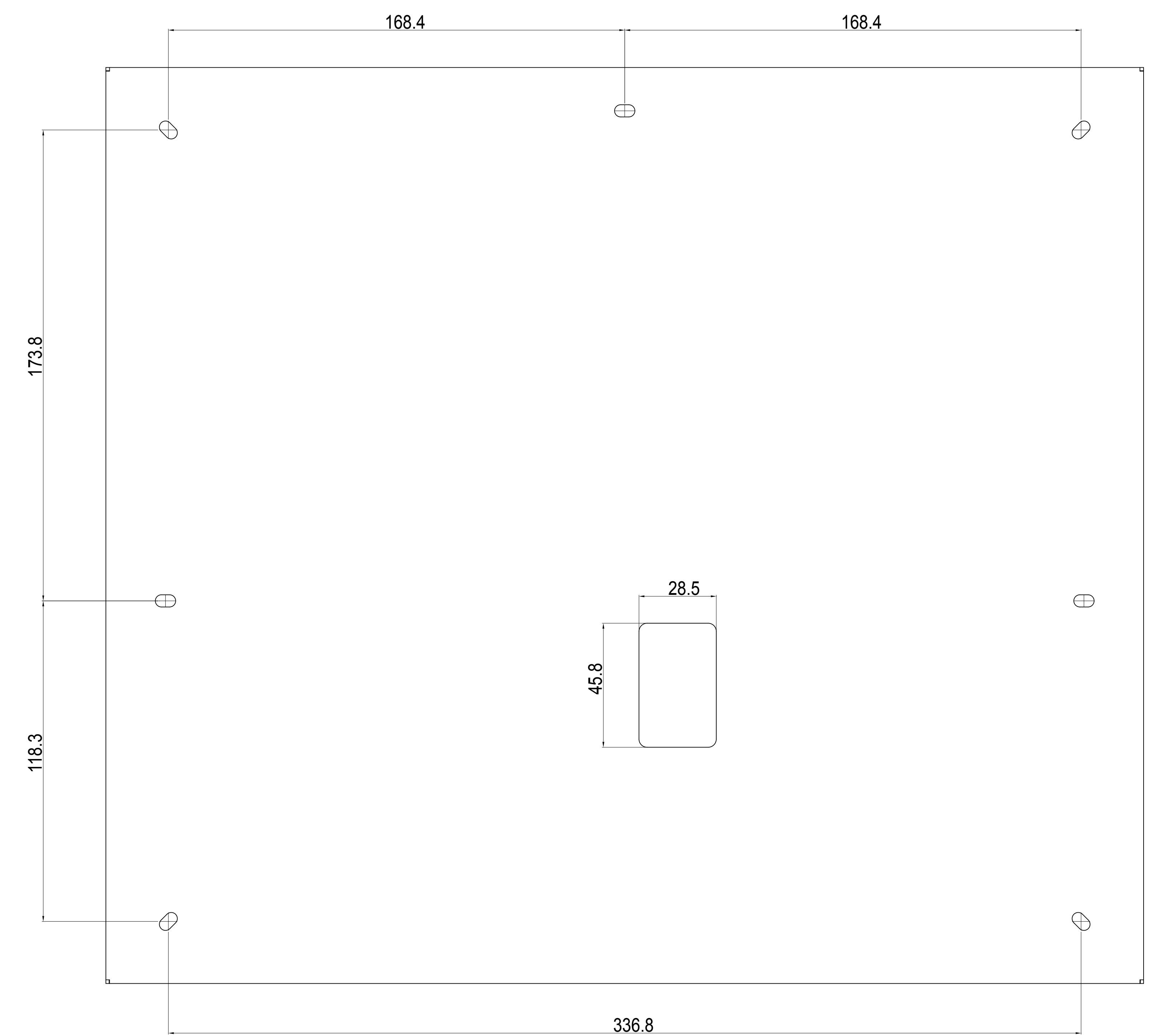

4 BACK VIEW

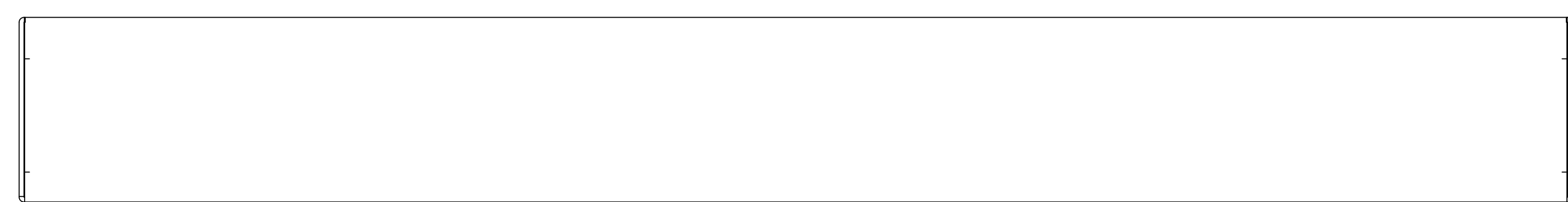

6 BOTTOM VIEW

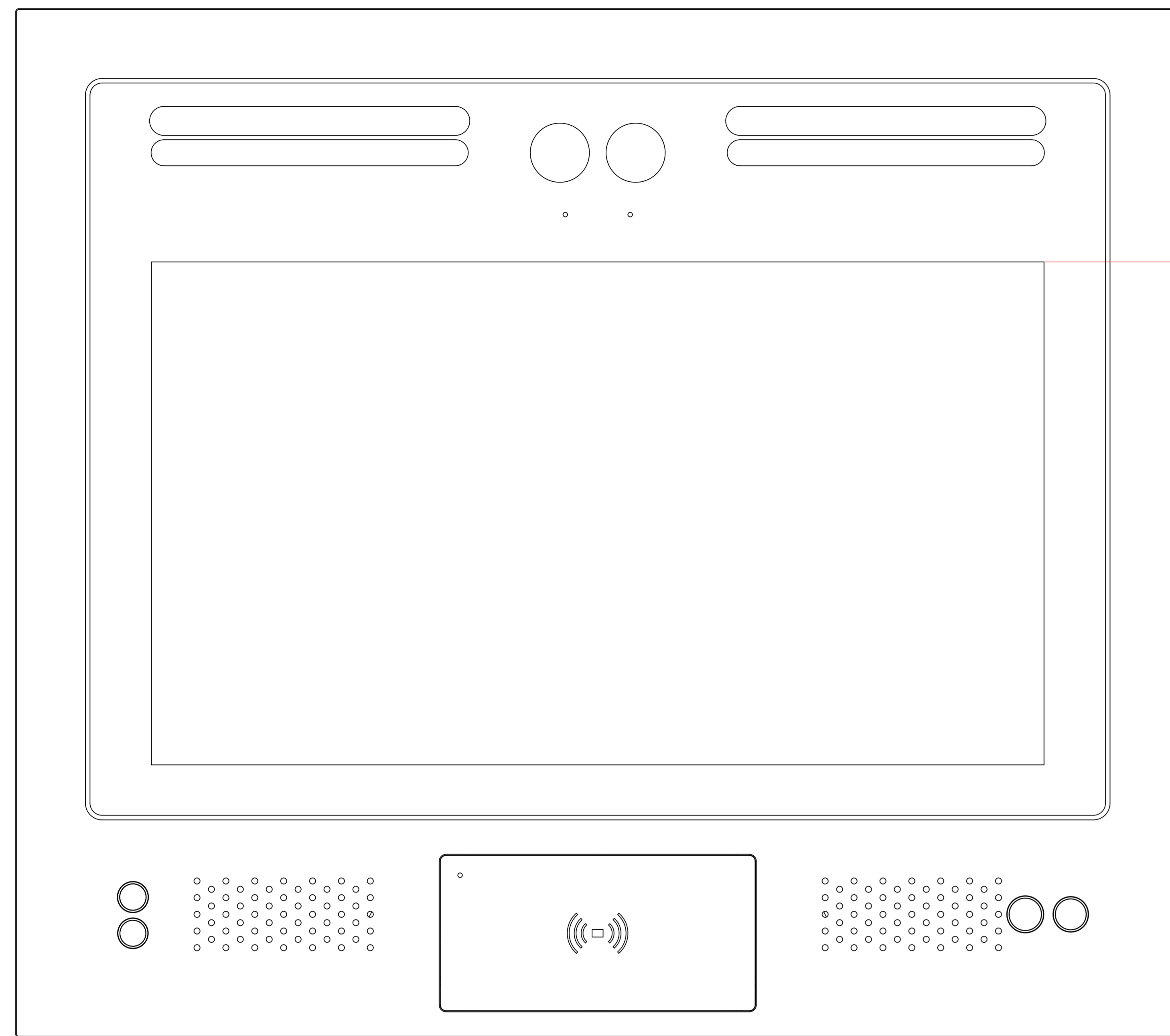

① INTERCOM PANEL FRONT VIEW

994.4mm TO BOTTOM OF PANEL

1200mm MAX TO TOP OF USABLE TOUCHSCREEN

ADA Compliance Requirement

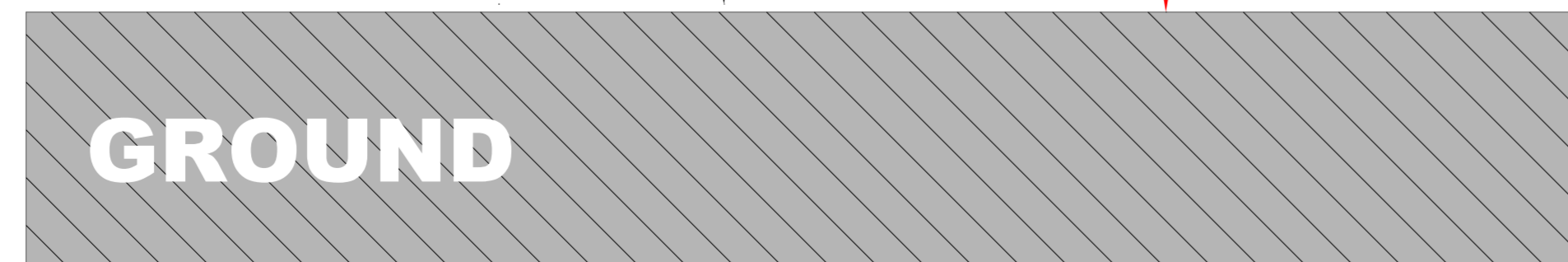

GROUND

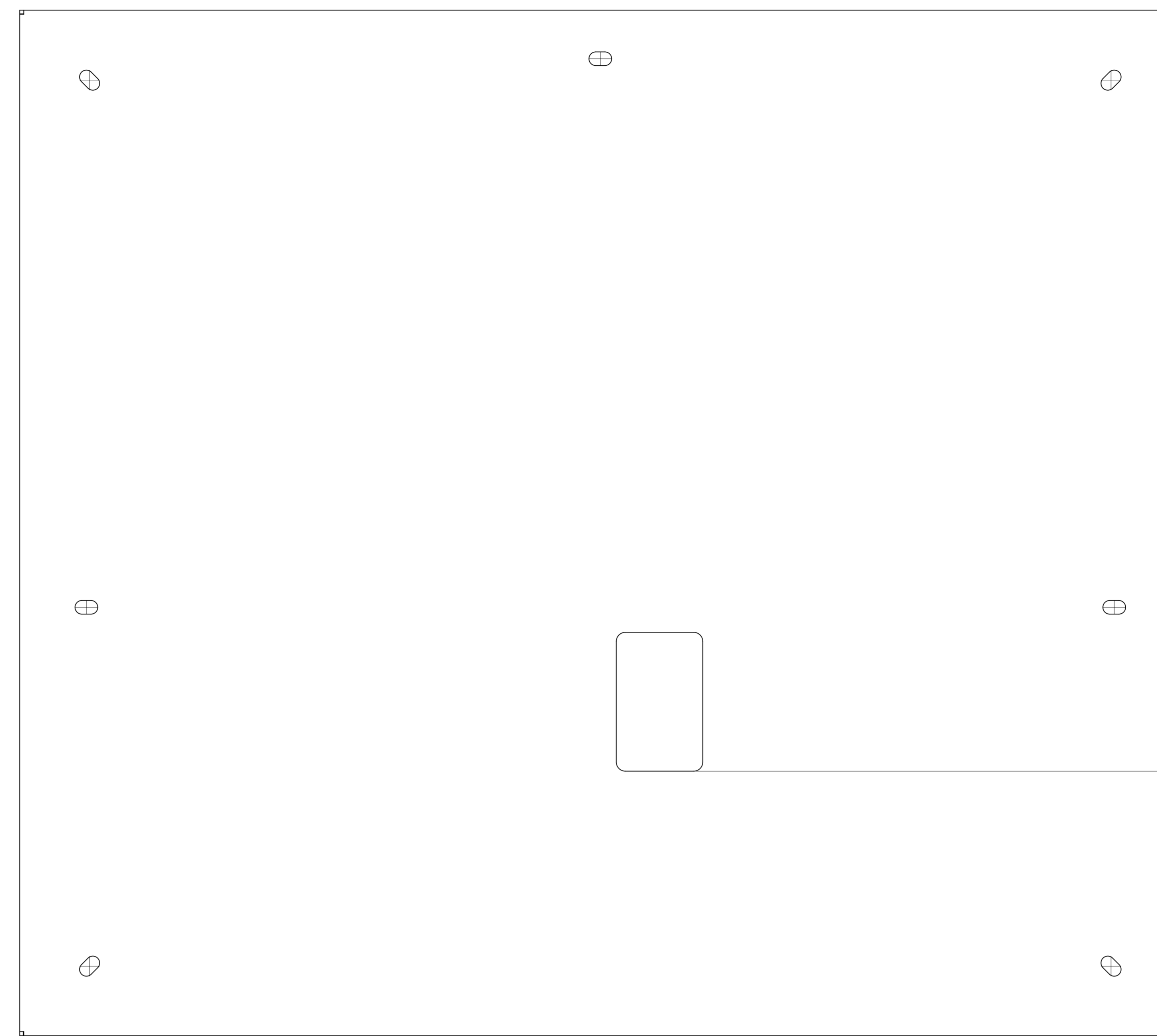

② FRONT VIEW:WALL MOUNTING BRACKET PLACEMENT

945.8mm TO BOTTOM OF BRACKET

1032.1mm TO HOLE EDGE OF BRACKET

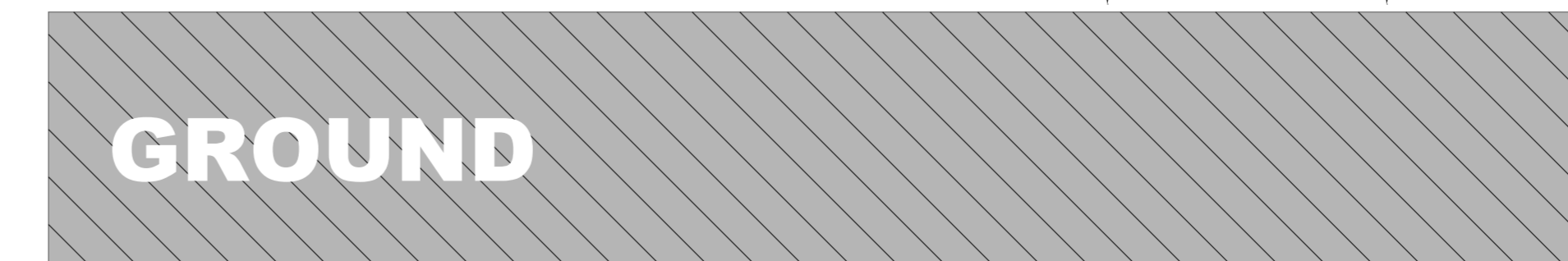

GROUND

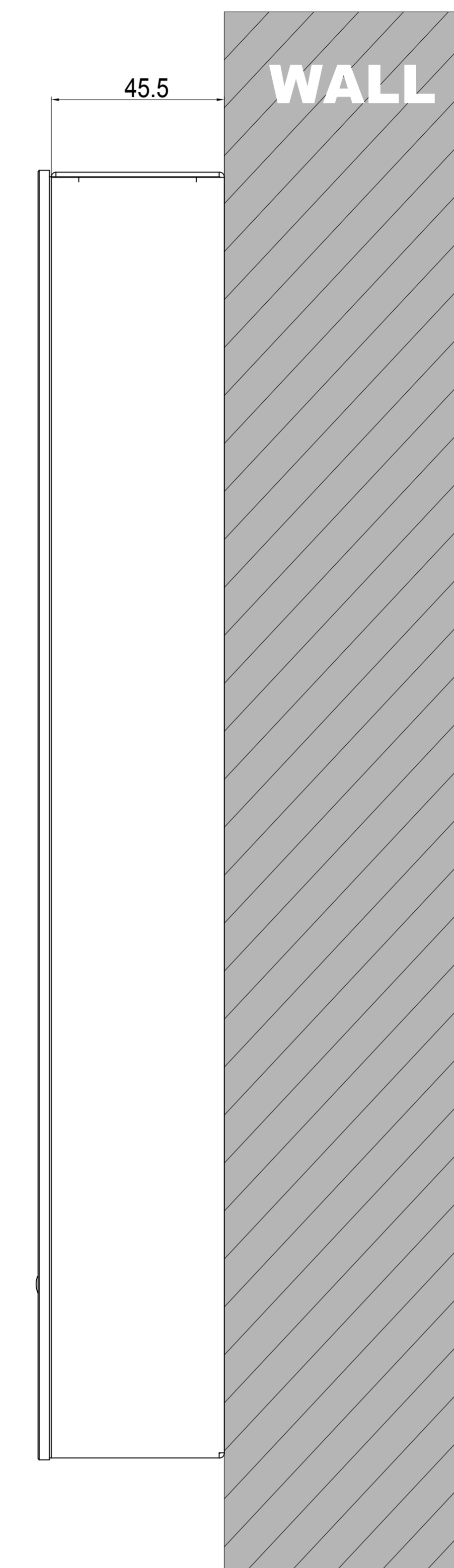

③ SIDE VIEW:INTERCOM ON WALL

45.5

WALL