

Grandstream Networks, Inc.

GXV3500

IP Video Encoder/Decoder

User Manual

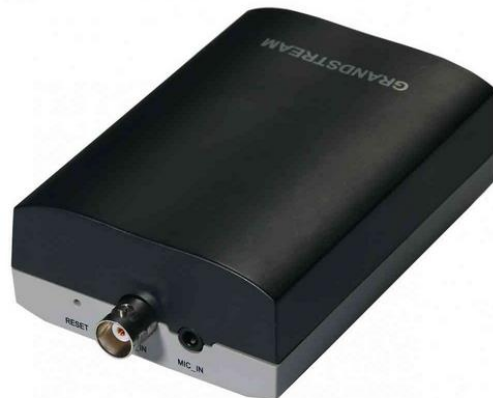

COPYRIGHT

©2021 Grandstream Networks, Inc. <http://www.grandstream.com>

All rights reserved. Information in this document is subject to change without notice. Reproduction or transmittal of the entire or any part, in any form or by any means, electronic or print, for any purpose without the express written permission of Grandstream Networks, Inc. is not permitted.

The latest electronic version of this user manual is available for download here:

<http://www.grandstream.com/support>

Grandstream is a registered trademark and Grandstream logo is trademark of Grandstream Networks, Inc. in the United States, Europe, and other countries.

CAUTION

Changes or modifications to this product not expressly approved by Grandstream, or operation of this product in any way other than as detailed by this User Manual, could void your manufacturer warranty.



WARNING

Please do not use a different power adaptor with your devices as it may cause damage to the products and void the manufacturer warranty.



SAFETY COMPLIANCES

These instructions are intended to assist users to safely operate the GXV3500, avoid dangerous situations or damage the device.

	
Warning : May cause serious injury or death if any of the warnings below are neglected.	Caution : Equipment may be damaged if any of the following caution messages are neglected.



Warning:

Input voltage should meet both the SELV (Safety Extra Low Voltage) and the Limited Power Source with DC 12V according to the IEC60950-1 standard. Please refer to the technical specifications for more details. Do not use a third-party power adapter or power cord. When the device installed on the wall or ceiling, make sure that it is firmly attached.



Caution :

- Make sure that the power supply voltage is correct before using the camera.
- Do not drop the device or expose it to physical shock.
- Do not expose the device to temperatures outside the range of 0°C to 45°C when the device is in operation.
- Do not expose the device to damp/wet conditions or high electromagnetism radiation.
- To avoid heat accumulation, make sure that your operating environment has proper ventilation.
- Do not damage the warranty sticker.

A few parts (e.g. electrolytic capacitor) of the equipment shall be replaced regularly according to their average lifetime. The average lifetime varies from the differences between operating environments and usage history. Regular maintenance checks are recommended for all users. Please contact your dealer for more details.

FCC CAUTION

Any Changes or modifications not expressly approved by the party responsible for compliance could void the user's authority to operate the equipment. This device complies with part 15 of the FCC Rules. Operation is subject to the following two conditions: 1) This device may not cause harmful interference. 2) This device must accept any interference received, including interference that may cause undesired operation.

Note: This equipment has been tested and found to comply with the limits for a Class B digital device, pursuant to part 15 of the FCC Rules.

These limits are designed to provide reasonable protection against harmful interference in a residential installation. This equipment generates uses and can radiate radio frequency energy and, if not installed and used in accordance with the instructions, may cause harmful interference to radio communications. However, there is no guarantee that interference will not occur in a particular installation. If this equipment does cause harmful interference to radio or television reception, which can be determined by turning the equipment off and on, the user is encouraged to try to correct the interference by one or more of the following measures:

- Reorient or relocate the receiving antenna.
- Increase the separation between the equipment and receiver.
- Connect the equipment into an outlet on a circuit different from that to which the receiver is connected.
- Consult the dealer or an experienced radio/TV technician for help.

RF Exposure Information (SAR)

This device is designed and manufactured not to be exceeded the emission limits for exposure to radio frequency RF energy set by the Federal Communications Commission of the United States. The exposure standard for wireless devices employing a unit of measurement is known as the Specific Absorption Rate (SAR), and the SAR limit set by FCC is 1.6 W/kg.

This device is complied with SAR for general population/uncontrolled exposure limits in ANSI/IEEE C95.1-1992, and has been tested in accordance with the measurement methods and procedures specified in OET Bulletin 65 Supplement C. This device has been tested and meets the FCC RF exposure guidelines when tested with the device directly contacted to the body. RF exposure compliance with anybody-worn accessory, which contains metal, was not tested and certified, and uses such body-worn accessory, should be avoided.

Changes or modifications not expressly approved by the party responsible for compliance could void the user's authority to operate the equipment.



Warranty

If the GXV3500 was purchased from a reseller, please contact the company where the device was purchased for replacement, repair, or refund.

If the device was purchased directly from Grandstream, please contact our technical support team for an RMA (Return Materials Authorization) number before the product is returned.

Grandstream reserves the right to remedy warranty policy without prior notification.



Caution:

Changes or modifications to this product not expressly approved by Grandstream, or operation of this product in any way other than as detailed by this User Manual, could void your manufacturer warranty.

Please do not use a different power adaptor with the GXV3500 because this may cause damage to the products and void the manufacturer warranty.

- This document is subject to change without notice. The latest electronic version of this user manual is available for download at:

http://www.grandstream.com/sites/default/files/Resources/gxv3500_user_manual.pdf

Reproduction or transmittal of the entire or any part, in any form or by any means, electronic or print, for any purpose is not permitted without the express written permission of Grandstream Networks, Inc.



Table of Contents

CHANGE LOG	12
Firmware Version 1.0.3.13	12
Firmware Version 1.0.3.12	12
Firmware Version 1.0.3.10	12
Firmware Version 1.0.3.9	12
Firmware Version 1.0.3.6	12
Firmware Version 1.0.3.3	12
Firmware Version 1.0.2.1	13
Firmware Version 1.0.1.98	13
Firmware Version 1.0.1.97	13
Firmware Version 1.0.1.95	13
Firmware Version 1.0.1.94	13
WELCOME	14
CONNECT YOUR GXV3500.....	15
Equipment Package Contents.....	15
Connecting the GXV3500	15
PRODUCT OVERVIEW	17
GXV3500 Camera	17
Technical Specifications.....	18
INSTALLATION GUIDE	20
Minimum Recommended Computer System Requirement	20
Configure the GXV3500 via Web Browser.....	20
<i>Windows Platform</i>	21
<i>Apple Platform</i>	23
Connect to the GXV3500 using Static IP	23



GXV3500 APPLICATION SCENARIOS.....	25
Battery Power or No network	25
LAN w/o Internet.....	25
LAN with Internet.....	26
GXV3500 Application Peripheral Connection	26
GXV3500 HOME WEB PAGE (ENCODER MODE).....	29
GXV3500 Configuration & Language Page	30
Basic Settings Explanation.....	31
<i>System Settings Page</i>	31
<i>Video & Audio Setting Page</i>	32
<i>Networking Setting Page</i>	35
<i>DDNS Settings Page</i>	36
<i>SIP Setting Page</i>	38
<i>Status Page</i>	42
Advanced Settings Explanation.....	42
<i>User Management Page</i>	42
<i>Maintenance Page</i>	44
<i>Certificates Page</i>	45
<i>SMTP Setting Page (Email Alarm)</i>	47
<i>FTP Settings Page (Upload Alarm)</i>	48
<i>PTZ</i>	49
<i>Alarm Server Settings Page</i>	49
<i>Time Lapse Photography</i>	51
<i>Motion Detection</i>	51
<i>Alarm Event</i>	54
<i>Syslog Settings</i>	55
SOFTWARE UPGRADE	57
CONFIGURATION FILE DOWNLOAD	58
RESTORE FACTORY DEFAULT SETTING	59



Reset from Web Interface (Soft Reset).....	59
Reset via Button (Hard Reset)	59
GXV3500 HOME WEB PAGE (DECODE MODE)	60
Home Page (Decode Mode)	60
Basic Settings Explanation (Decode Mode).....	62
<i>System Setting Page (Decode Mode)</i>	62
<i>Audio Setting Page (Decode Mode)</i>	63
<i>Networking Setting Page (Decode Mode)</i>	64
<i>DDNS Setting Page (Decode Mode)</i>	65
<i>SIP Setting Page (Decode Mode)</i>	66
<i>Status Page (Decode Mode)</i>	69
Advanced Settings Explanation (Decode Mode).....	70
<i>User Management Page (Decode Mode)</i>	70
<i>Maintenance Page (Decode Mode)</i>	72
<i>Certificates Page</i>	73
<i>PTZ (Decode Mode)</i>	75
<i>Remote Alarm_Out Peering with GXV3500 (Decode Mode)</i> :	75
<i>Syslog Settings (Decode Mode)</i>	80
IP SURVEILLANCE FAQ	81
EXPERIENCING THE GXV3500.....	85



Table of Tables

Table 1: GXV3500 Technical Specifications.....	18
Table 2: GXV3500 Power Specifications	25
Table 3: Home page options (Encoder Mode)	29
Table 4: System settings page options (Encoder Mode)	32
Table 5: Video & Audio settings.....	34
Table 6: Networking Setting	35
Table 7: DDNS Setting	37
Table 8: SIP Setting	39
Table 9: User Management page	43
Table 10: User Management page	44
Table 11: SMTP page	47
Table 12: FTP Settings page.....	48
Table 13: PTZ Settings page.....	49
Table 14: Alarm HTTP Server Settings	50
Table 15: Time Lapse Photography Configuration	51
Table 16: Motion Detection Configuration.....	52
Table 17: Alarm_In Action Configuration.....	54
Table 18: Syslog settings	56
Table 19: Decode Home settings	60
Table 20: System settings	63
Table 21: Networking settings	64
Table 22: DDNS Setting	65
Table 23: SIP Setting Page (Decode).....	67
Table 24: User Management (Decode).....	71
Table 25: User Management page	72
Table 26: Configuration Page (Decode).....	75
Table 27: Syslog (Decode).....	80



Table of Figures

Figure 1: GXV3500 Package	15
Figure 2: GXV3500 Connection diagram.....	16
Figure 3: GXV3500 IP Camera front view.....	17
Figure 4: GXV3500 IP Camera rear view	17
Figure 5: AV Cable standard example	18
Figure 6: Windows “network” showing gxv3500 as “other devices” via UPNP	21
Figure 7: GS_SEARCH Result page of GXV3500	22
Figure 8: Apple Safari “Bonjour” Setting page to display GXV3500.....	23
Figure 9: Apple Safari “Bonjour” Setting page to display GXV3500.....	23
Figure 10: Application peripheral connection for GXV3500	26
Figure 11: Alarm_In and Alarm_Out Connection Circuit Sample for GXV3500	27
Figure 12: Home page of gxv3500 (encoder mode).....	29
Figure 13: Web language switch	30
Figure 14: System Settings page	31
Figure 15: Video & Audio Settings Page.....	33
Figure 16: Networking Setting Page.....	35
Figure 17: DDNS Setting Page	36
Figure 18: SIP Setting Page (part 1)	38
Figure 19: SIP Setting Page (part 2)	39
Figure 20: Status Page	42
Figure 21: User Management Page	43
Figure 22: Maintenance page	44
Figure 23: Certificates page.....	46
Figure 24: SMTP page.....	47
Figure 25: FTP Settings Page.....	48
Figure 26: PTZ Setting Page.....	49
Figure 27: Alarm HTTP Server Setting Page	50
Figure 28: Time Lapse Photography Configuration Page.....	51
Figure 29: Motion Detection Configuration Page	52
Figure 30: Motion Detection Schedule Configuration Page.....	53
Figure 31: Alarm_In Action Configuration Page	54
Figure 32: Alarm Event Time Schedule Configuration Page.....	55
Figure 33: Syslog setting page.....	56
Figure 34: Firmware Upgrade and Provisioning.....	57
Figure 35: Factory Reset from Web Interface	59
Figure 36: GXV3500 Front View	59
Figure 37: Decode Home Page.....	60



Figure 38: System Page (Decode)	62
Figure 39: Audio Setting Page (Decode)	63
Figure 40: Networking Page (Decode)	64
Figure 41: DDNS Setting Page (Decode)	65
Figure 42: SIP Setting Page (Decode)	67
Figure 43: Status Page (Decode)	70
Figure 44: User Management Page (Decode)	71
Figure 45: Maintenance Page (Decode)	72
Figure 46: Certificates page	74
Figure 47: PTZ Configuration Page (Decode)	75
Figure 48: Remote Alarm_Out IP Camera Configuration	76
Figure 49: Remote Alarm_Out peering GXV3500 Configuration	77
Figure 50: Remote Alarm_Out peering GXV3500 Action Output Display	78
Figure 51: Peering GXV3500 Decode Alarm_Out Circuit	79
Figure 52: Syslog Page (Decode)	80



CHANGE LOG

This section documents significant changes from previous versions of user manual for GXV3500. Only major new features or major document updates are listed here. Minor updates for corrections or editing are not documented here.

Firmware Version 1.0.3.13

- No major change.

Firmware Version 1.0.3.12

- Added support for “Auto-Answer After Ring Timeout” (Encoder). [Answer Mode]

Firmware Version 1.0.3.10

- No major change.

Firmware Version 1.0.3.9

- No major change.

Firmware Version 1.0.3.6

- Added support for HTTPS web access. [Web Access Mode]
- Added option to Enable/Disable HTTP web access. [Web Access]

Firmware Version 1.0.3.3

- Added schedule for firmware upgrade and provisioning. [Maintenance Page]
- Added ability to enable multiple audio codecs simultaneously and specify priority of codecs. [SIP Setting Page]
- Added support to validate server certificate. [Certificates Page]
- Added support for VLAN. [Networking Setting Page]
- Added support for “Voice Frame per TX” on audio settings. [SIP Setting Page]
- Added ability to upload trusted certificates and to configure device with custom certificate signed by custom CA certificate. [Certificates Page]
- Increased the “Ring Timeout” limit to 5 minutes. [SIP Setting Page]
- Added support for alarm out pattern. [System Settings Page]
- Added support for “Reregister before Expiration” option. [SIP Setting Page]
- Added support HTTPS Web access. [Networking Setting Page]
- Added ability to disable 3CX PnP feature. [Maintenance Page]



Firmware Version 1.0.2.1

- Added support for new Grandstream MAC block: C0:74:AD

Firmware Version 1.0.1.98

- Added support for DHCP Option 66. [DHCP Option 66 Override Server]
- Add support for DNS SRV mode. [DNS Mode]

Firmware Version 1.0.1.97

- Added activating alarm out directly upon receiving SIP call.

Firmware Version 1.0.1.95

- Changed the WEB UI color tone to dark blue and updated the Logo.

Firmware Version 1.0.1.94

- Added displaying black screen to external monitor/TV when network is disconnected.



WELCOME

Thank you for purchasing Grandstream's GXV3500, a powerful device to convert analogue camera to IP network camera (encoder mode) or display real-time stream to big screen TV (decode mode).

GXV3500 is a next generation Encoder/Decoder. It features cutting-edge H.264 real-time video compression, industry leading SIP/VoIP for 2-way audio and video streaming to smartphones and videophones, PoE, best-in-class scalability and ease of integration, and advanced security protection. The unique incorporation of TCP/IP protocols creates sophisticated, flexible networking and remote-control abilities.

The GXV3500 features the advanced functionality of embedded analytics (motion detection). The built-in Alarm_In and Alarm_Out interface can be used to linked analogue camera, can also be peered to configured IP camera as external and remote Alarm_Out, saved the direct wiring to the camera via Ethernet network connection.

The GXV3500 can be managed with GSurf Pro (Grandstream's intuitive FREE video management software that controls up to 72 cameras simultaneously) or grouped with GVR3550/3552 Grandstream Network Video Recorder (NVR) via plug-n-play, as well as other ONVIF compliant video management systems. It also offers an advanced and flexible HTTP API and an SDK for easy integration with other surveillance systems.

Designed for indoor environment application, the GXV3500 is a robust surveillance solution for broad range of application environments such as banks, hotels, schools, retail stores and small warehouses, offices or building entrances, and other small to median sized enclosed environments.



CONNECT YOUR GXV3500

Equipment Package Contents

- GXV3500 – 1 Channel digital video encoder/Decode
- 12V DC Universal Power Adaptor
- 3.5mm to RCA audio/video cable
- Quick Installation Guide

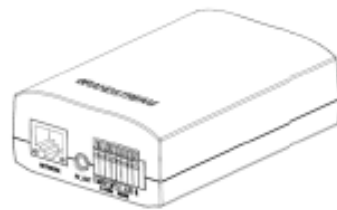

GXV 3500



12V Power Supply



TV out RCA cable



QuickStart Guide

Figure 1: GXV3500 Package

Connecting the GXV3500

1. Using the Power Adapter as power supply

- Connect the RJ45 Ethernet cable to the NETWORK port of the GXV3500
- Connect the other end of the RJ45 cable to your network (switch, router, or PC)
- Connect the power supply to the DC 12V power clamps on the back of the GXV3500
- Connect the GXV3500 Video into the analog camera Video Out port via BNC cable.
- Connect 3rd party 3.5mm external microphone to “MIC_IN” port of GXV3500 if audio required.

2. Using PoE as power supply



- Connect the RJ45 Ethernet cable to the NETWORK port of GXV3500
- Connect the other end of the RJ45 cable to your PoE switch
- PoE injector can be used if PoE switch is not available.
- Connect the GXV3500 “Video In” to the analog camera “Video Out” port via BNC cable.
- Connect 3rd party 3.5mm external microphone to “MIC_IN” port of GXV3500 if audio required.

Please refer to following connection diagram to hook up the camera and external 3rd party accessories.

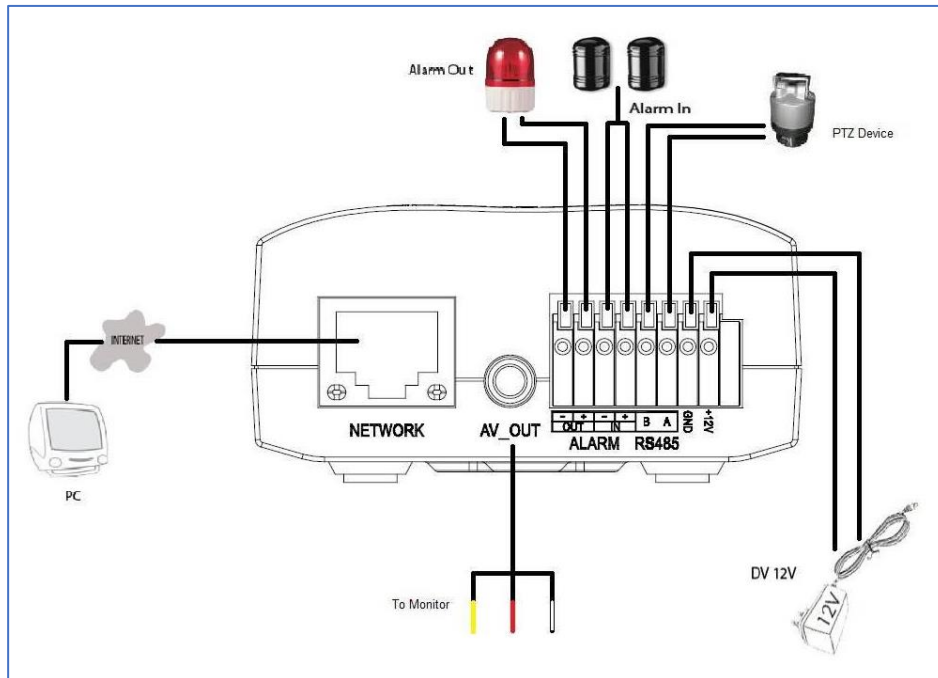

Figure 2: GXV3500 Connection diagram

PRODUCT OVERVIEW

GXV3500 Camera

Please see below the diagram and explanation of GXV3500 IP camera:



Figure 3: GXV3500 IP Camera front view

1. **V_IN, BNC Interface:** GXV3500 BNC interface, connect to analog camera as Video Input (Voltage: 1.0V p-p; Resistance 75 Ω).
2. **MIC_IN:** 3.5mm socket for external 3rd party microphone input.
3. **RESET:** PIN hole, press & hold for 15 seconds to factory reset the device.



Figure 4: GXV3500 IP Camera rear view

1. **NETWORK:** 10/100 RJ45 network socket for Ethernet connection.
2. **AV_OUT:** 3.5mm to RCA audio/video connection output to display device like TV.
3. **ALARM OUT:** 1 Channel Alarm Output port for device like Siren.
4. **ALARM IN:** 1 Channel Alarm Input port for device like Infrared Motion Detector.
5. **RS-485:** 1 Channel RS-485 Interface for cameras with PTZ Controller.
6. **DC 12 V:** 12V DC power port. Insert the positive bare wire +12V; insert the negative bare wire into the GND port. Do NOT connect wrongly.

Note: "Pin Out" of the 3.5mm AV cable used for GXV3500 (highlight in Blue)

- 1: **Ground;**
- 2: **Video (Yellow);**
- 3: **Audio Right (Red);**
- 4: **Audio Left (White).**

Same as the AV cable used in Apple iBook, etc.

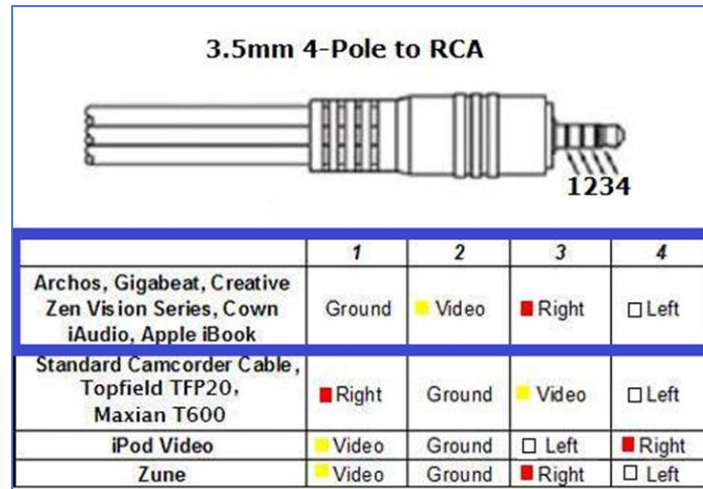

Figure 5: AV Cable standard example

Technical Specifications

The following table resumes all the technical specifications including the protocols / standards supported, voice codecs, telephony features and upgrade/provisioning settings for GXV3500.

Table 1: GXV3500 Technical Specifications

Channel	1
Video Compression (Encoder)	H.264, MJPEG, JPEG
Video Decompression (Decode)	H.264 ONLY
Max. Video Resolution (Encoding)	Encoding (4CIF): 704x480@30fps (NTSC); 704x576@25fps (PAL)
Max. Video Resolution (Decoding)	Decoding (4CIF): 720x480@30fps (NTSC); 720x576@25fps (PAL)
Video Bit Rate	16 Kbps ~ 2 Mbps
Video Input (Encoder Mode)	1, BNC (Voltage: 1.0Vp-p; Resistance: 75Ω)
Video Output (Decode Mode)	1, 3.5mm to RCA Line-Out
Audio Compression	G.711 a/u (PCMA, PCMU)
Audio Input	1, 3.5mm Line In (Resistance: 1.5KΩ)
Audio Output	1, 3.5mm to RCA Line-Out (600Ω, 0.707 Vrms)
Alarm Input	1, PIN, Voltage < 45V, Current (DC) < 50mA, Normal Open (Low)



Alarm Output	1, PIN, Voltage < 80V, Current < 50mA, Normal Open (Low)
PTZ Control	1, PIN, via RS-485
Embedded Analytics	Motion Detection (up to 16 target areas)
Pre-/Post-Alarm Recording	Yes
Security	On screen display, HTTPS, Password
Snapshots	Triggered upon Events, Send via email and/or FTP
SIP/VoIP Support	Yes, Voice and Video
Power over Ethernet (PoE)	IEEE 802.3af Class 0; 10M/100M Auto-sensing, 2KV Lightning Surge Protection.
Network Protocol	TCP/UDP/IP, RTP/RTCP, RTSP, DHCP, DDNS, HTTP, HTTPS, SMTP, FTP, NTP
Cable Connections	<ul style="list-style-type: none"> • BNC for Video In • 3.5mm Audio Line-In • RJ45 Ethernet • 3.5mm to RCA Video and Audio Line-Out • PINs for Alarm-In, Alarm-Out, PTZ and Power Input
Dimensions	67mm x 34mm x 96mm
Weight	121g or 4.3oz
Temperature / Humidity	Operating: 0°C ~ +45°C (32°F ~ 113°F), 10 – 90% RH (Non-condensing) Storage: -20°C ~ +60°C (-4°F ~ 140°F)
Power Adapter	Output: 12VDC/0.5A; Input: 100–240VAC, 50–60Hz
Compliance	FCC Part 15, Subpart B Class B; EN 55022 Class B, EN 61000-3-2, EN 61000-3-3, EN 55024, EN 60950-1; RCM AS/NZS CISPR 22/24, AS/NZS 60950

INSTALLATION GUIDE

Minimum Recommended Computer System Requirement

To install GXV3500, you have to have a computer, PC recommend.

The minimum recommended PC system requirement listed below:

- Windows XP, Windows Vista, Windows 7, and Windows 8
- CPU: Intel Pentium 4 or higher, 2 GHz
- RAM: 2 GB (4 GB recommended for larger systems)
- Support for DirectX 8.0 and above.

Configure the GXV3500 via Web Browser

The GXV3500 has embedded Web server to respond to HTTP GET/POST requests. Embedded HTML pages allow user to configure the IP camera through Microsoft Internet Explorer (7.0 or above), Firefox, Chrome (plug-in from Grandstream required).

Download WebControl Plug-in from Grandstream website:

http://www.grandstream.com/products/tools/surveillance/webcontrol_plugin.zip

Notes:

- Please temporarily disable Antivirus or Internet Security Software when download and install the Grandstream WebControl Plug-in for Firefox/Chrome or “GSViewerX.cab” for Microsoft Internet Explorer. Please close Browser to install the downloaded Plug-in or Active-X.
- Please trust and install the file downloaded if prompted by the Antivirus or Security software.
- For Apple platform (OS-X or iOS), only MJPEG (video encode mode) supported currently.

Connect the Camera to network with DHCP server (Recommended)

The GXV3500 by default enabled as DHCP client, it will automatically get IP address from the network with DHCP server running.



Windows Platform

There are two ways for Windows user to get access to the IP Camera easily:

A. UPnP

By default, the GXV3500 has the UPnP feature turned ON. For customers using Window network with UPnP turned on (most SOHO router support UPnP), it is very easy to access the IP camera:

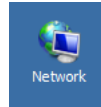

- Find the “Network” icon at Windows Desktop.
- Click the icon to get into the “Network” and the IP cameras will list as “Other Devices” shown like below. Refresh the pages if nothing displayed. Otherwise, the UPnP may not be active in the network.

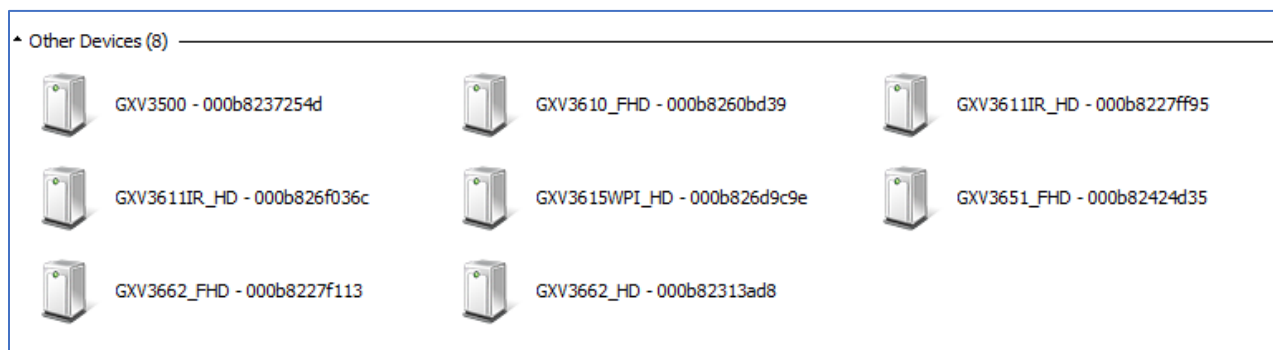

Figure 6: Windows “network” showing gxv3500 as “other devices” via UPNP

- Click the displayed icon of related IP camera, the default browser (e.g.: Firefox or Chrome) will open and connect directly to the camera’s webpage, prompt message will display asking for plug-in installation.
- Disable security or antivirus software, download the plug-in, close browser, and install the plug-in, open the browser again, the embedded video will be displayed if clicking the icon of the related IP Camera.

B. “GS Search” Utility Tool

User can know the IP address assigned to the camera from DHCP server log or using the Grandstream GS_Search tool. Following is the instruction for using “GS_Search” utility tool:

1. Download the GS_Search tool from Grandstream website:
http://www.grandstream.com/products/tools/surveillance/GS_Search.zip
2. Run the Grandstream GS_Search tool by double click the unzipped “GS_Search.exe”.
3. Click on the button to begin device detection
4. The detected devices will appear in the output field like below:



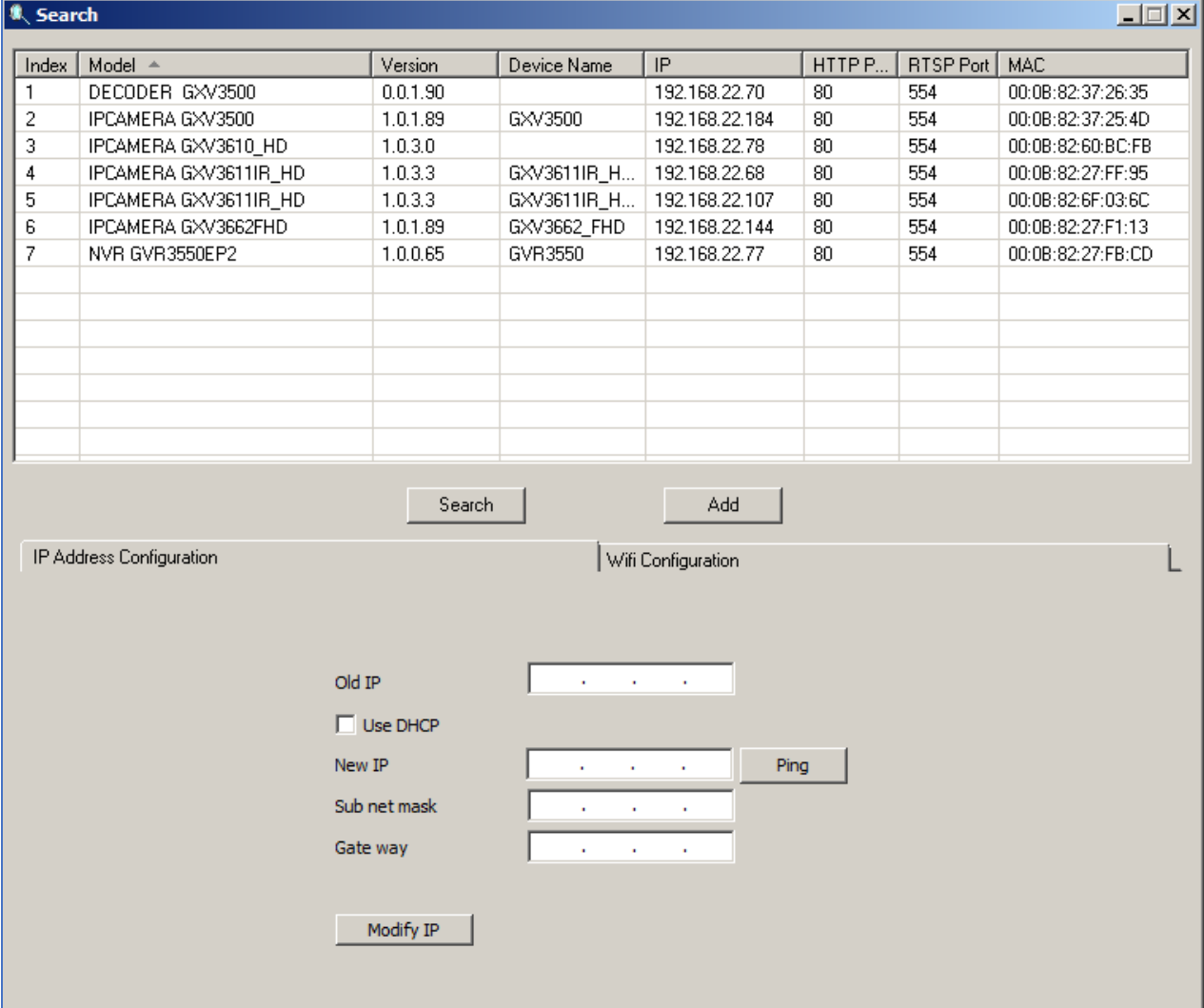

The screenshot shows a window titled "Search" with a table of detected devices. Below the table are "Search" and "Add" buttons. At the bottom, there are two tabs: "IP Address Configuration" (selected) and "Wifi Configuration". The IP configuration form includes fields for Old IP, New IP, Sub net mask, and Gate way, along with checkboxes for "Use DHCP" and a "Ping" button. A "Modify IP" button is located at the bottom of the form.

Index	Model	Version	Device Name	IP	HTTP P...	RTSP Port	MAC
1	DECODER GXV3500	0.0.1.90		192.168.22.70	80	554	00:0B:82:37:26:35
2	IPCAMERA GXV3500	1.0.1.89	GXV3500	192.168.22.184	80	554	00:0B:82:37:25:4D
3	IPCAMERA GXV3610_HD	1.0.3.0		192.168.22.78	80	554	00:0B:82:60:BC:FB
4	IPCAMERA GXV3611IR_HD	1.0.3.3	GXV3611IR_H...	192.168.22.68	80	554	00:0B:82:27:FF:95
5	IPCAMERA GXV3611IR_HD	1.0.3.3	GXV3611IR_H...	192.168.22.107	80	554	00:0B:82:6F:03:6C
6	IPCAMERA GXV3662FHD	1.0.1.89	GXV3662_FHD	192.168.22.144	80	554	00:0B:82:27:F1:13
7	NVR GVR3550EP2	1.0.0.65	GVR3550	192.168.22.77	80	554	00:0B:82:27:FB:CD

Figure 7: GS_SEARCH Result page of GXV3500

5. Double click the column of the detected camera, the browser will automatically open and link to the device IP and the web configuration page.
6. The browser will ask for plug-in or ActiveX if not installed, otherwise it will get to Home page and start to show the video captured by the camera (by default the camera enabled anonymous access)
7. Click "Configuration" icon, the browser will ask credentials to authorize configuration.
8. Enter the administrator user name and password to access the Web Configuration Interface, the default user name and password are both set to **admin**.
9. In step 6, browser will indicate that "This website wants to install the following add-on: GSViewerX.cab from Grandstream Networks Inc." Please allow the installation.
10. The plug-in can be download here:

http://www.grandstream.com/products/tools/surveillance/webcontrl_plugin.zip



Apple Platform

For Apple users, please turn on Bonjour of Safari to find and access the GXV3500.

- 1) Open Safari, select “Advanced” to open the Advanced Setting.
- 2) Click “Include Bonjour in the Bookmarks menu” and “Include Bonjour in the Favorites bar” then close the setting page and back to Safari.



Figure 8: Apple Safari “Bonjour” Setting page to display GXV3500

- 3) Bonjour will now display embedded at Safari. Select “Bonjour” pull-down menu and select “Webpages”, the related IP Camera like GXV3500 will be there.

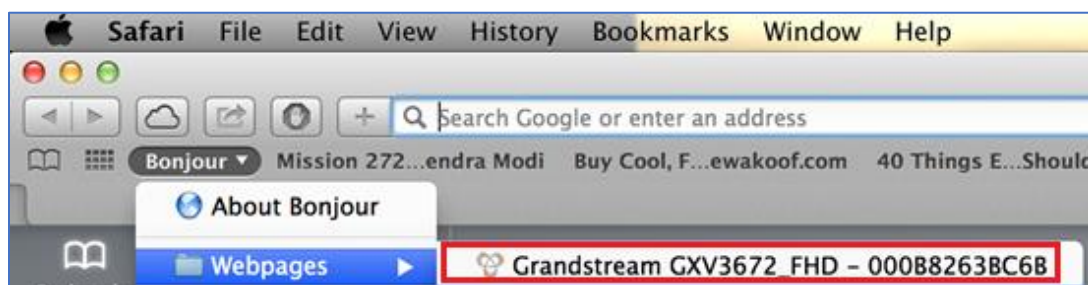

Figure 9: Apple Safari “Bonjour” Setting page to display GXV3500

- 4) Click the displayed camera to access to the configuration page of the camera.

Connect to the GXV3500 using Static IP

If no DHCP server in the network, or the camera does not get IP from DHCP server, user can connect the camera to a computer directly, using static IP to configure the camera.

The default IP, if no DHCP server; or DHCP offer time out (3 minutes), is **192.168.1.168**



1. Connect the computer network port via an Ethernet cable directly to the IP camera GXV3500.
2. Configure the computer using Static IP: 192.168.1.XXX (1<XXX<255, but NOT 168) and configure the “Subnet mask” to “255.255.255.0”. Leave the “Default Gateway” to “Blank” like below: (Example of Windows platform, Apple platform is similar)

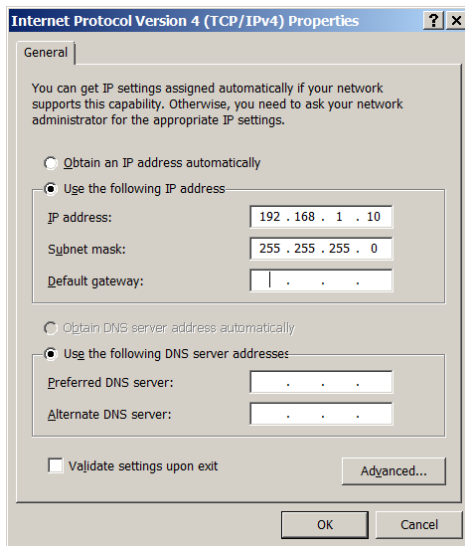

3. Power on the GXV3500.
4. Start the browser when the network connection is up.
5. Enter 192.168.1.168 in the address bar of the browser.
6. The browser will ask for plug-in or ActiveX if not installed, otherwise it will get to Home page and start to show the video captured by the camera (by default the camera enabled anonymous access)
7. Click “Configuration” icon, the browser will ask credentials to authorize configuration.
8. Enter the administrator user name and password to access the Web Configuration Interface, the default user name and password are both set to **admin**.
9. In step 6, IE will indicate that “This website wants to install the following add-on: GSViewerX.cab from Grandstream Networks Inc.”, allow the installation.
10. Firefox, Chrome user need to download and install the plug-in to see the video, the plug-in is here: http://www.grandstream.com/products/tools/surveillance/webcontrl_plugin.zip

Note:

- Please temporarily disable Antivirus or Internet Security Software and close all browsers when download and install the Grandstream Plug-in Software.



GXV3500 APPLICATION SCENARIOS

GXV3500 is a very versatile indoor device, it can be used in a lot of scenarios.

Battery Power or No network

For environment like remote warehouse/storage, grocery store, small (take-out) restaurants, the GXV3500 will meet your basic surveillance requirement

This is idea solution to upgrade the traditional standalone CCTV security system, while leave the potential of operating it in IP network when the network is available. All you need is power (could be battery), network wiring is not necessarily required and can leave to future upgrade when it available.

Table 2: GXV3500 Power Specifications

Product	Power Adapter Model			POE Model			Class Advertisement (IEEE 802.3af)
	Standby	Operating	Max Power	Standby	Operating	Max Power	
	Power(W)	Power(W)	Power(W)	Power(W)	Power(W)	Power(W)	
GXV3500	1.49	1.55	1.60	1.93	1.98	2.05	0

Equipment List:

- 1) GXV3500
- 2) Ethernet cable and PoE injector (Optional)

Depending on the space monitored, one or several GXV3500 may be required.

LAN w/o Internet

For multi-room or a bigger space, multiple GXV3500 might be required. User can establish a local area network using PoE switch.

If remote access required, a router with internet access may add in.

Equipment List:

- 1) Several GXV3500
- 2) Ethernet cables
- 3) Switch (Static IP required to configure to IP Cameras)
- 4) PoE Switch (Optional, better solution)

If remote access to the cameras required to view the LIVE video stream, then broadband Internet is required, and more equipment required:

- 5) Router (if DHCP configured than static IP is not required although still recommended)
- 6) Broadband Internet Access (FiOS, Cable or DSL)
- 7) iPhone or Android phone.



LAN with Internet

For multi-room or a bigger space, with Internet access and local video recording required, following list is recommended:

Equipment List:

- 1) Several GXV3500
- 2) GVR3550/2 NVR
- 3) Ethernet cables
- 4) Switch (PoE Switch recommended)
- 5) Router
- 6) Broadband Internet Access (FiOS, Cable or DSL)
- 7) iPhone or Android phone
- 8) GSurf_Pro Remote Access (Optional)

GXV3500 Application Peripheral Connection

Below is the illustration of GXV3500 peripheral connections for related application.

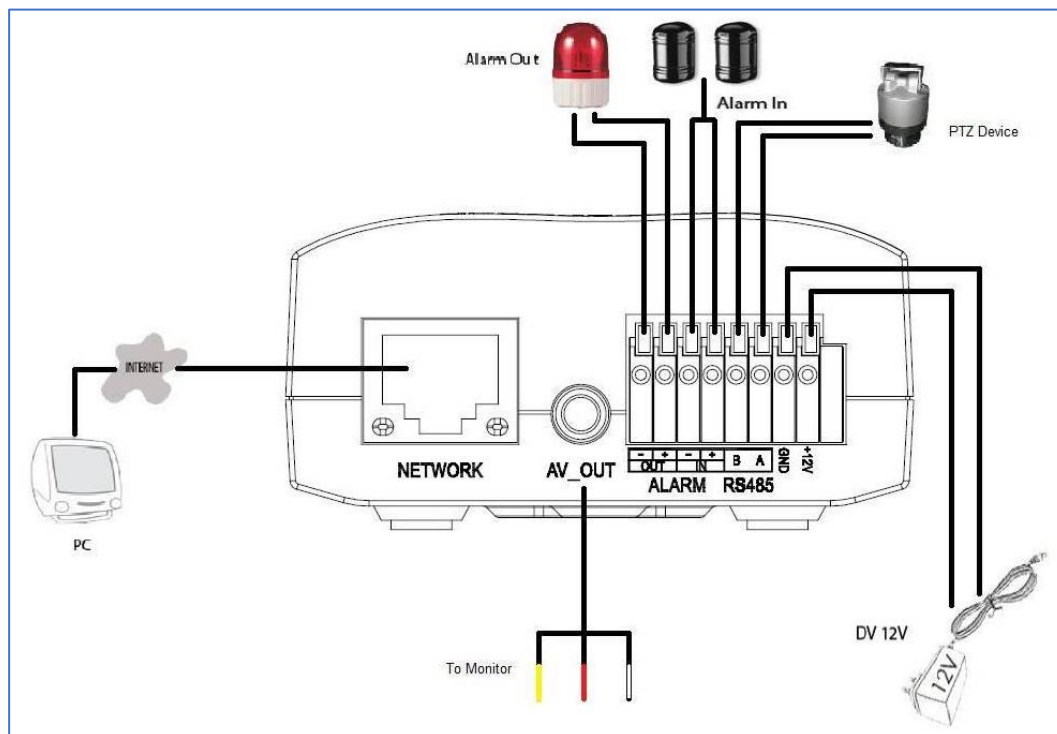

Figure 10: Application peripheral connection for GXV3500

Notes:

- For days of video storage, please use Motion Detection Event Video Recording, or using Grandstream GVR3550/2, or GSurf_Pro VMS.
- Alarm_In could use any 3rd party Sensors (like IR Motion Sensor) or Intercom Push Button, etc.
- Alarm_Out device could use 3rd party Siren and Strobe Light, or Electric Door Striker, etc.
- Audio Input (Microphone) and Audio Output (Amplified Speaker) using 3.5mm interface and must match below impedance parameter:

Audio Input	• 3.5mm Line-In (1.5KΩ)
Audio Output	• 3.5mm Line-Out (600Ω, 0.707 Vrms)

- Grandstream Video Phone can work with GXV3500 via either Peer IP (LAN) or SIP extension (WAN).
- Peer to Peer (or Direct IP) works only at LAN using static IP; SIP extension requires related SIP server/proxy provided and configured.

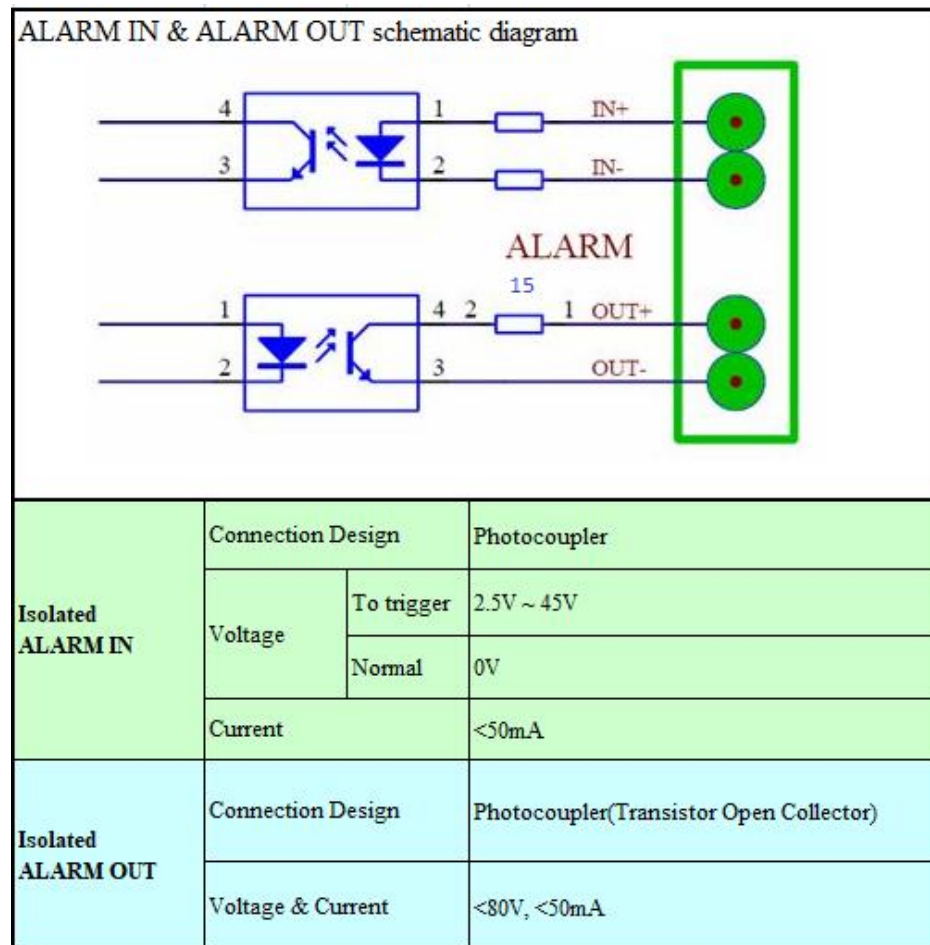

Figure 11: Alarm_In and Alarm_Out Connection Circuit Sample for GXV3500

Notes:

- The Alarm_In and Alarm_Out circuit connection has to be similar to above circuit diagram and meet following requirement:

Alarm Input	1, PIN, Voltage < 45V, Current (DC) < 50mA, Normal Open (Low)
Alarm Output	1, PIN, Voltage < 80V, Current < 50mA, Normal Open (Low)

- The Alarm_In circuit (like above photo coupler), if there is any voltage change smaller than 15V, as specification listed), the GXV3500 Alarm_In port will detect it and trigger the action and event.
- Higher voltage and wrong polarity connection are prohibited because this will damage the devices.



GXV3500 HOME WEB PAGE (ENCODER MODE)

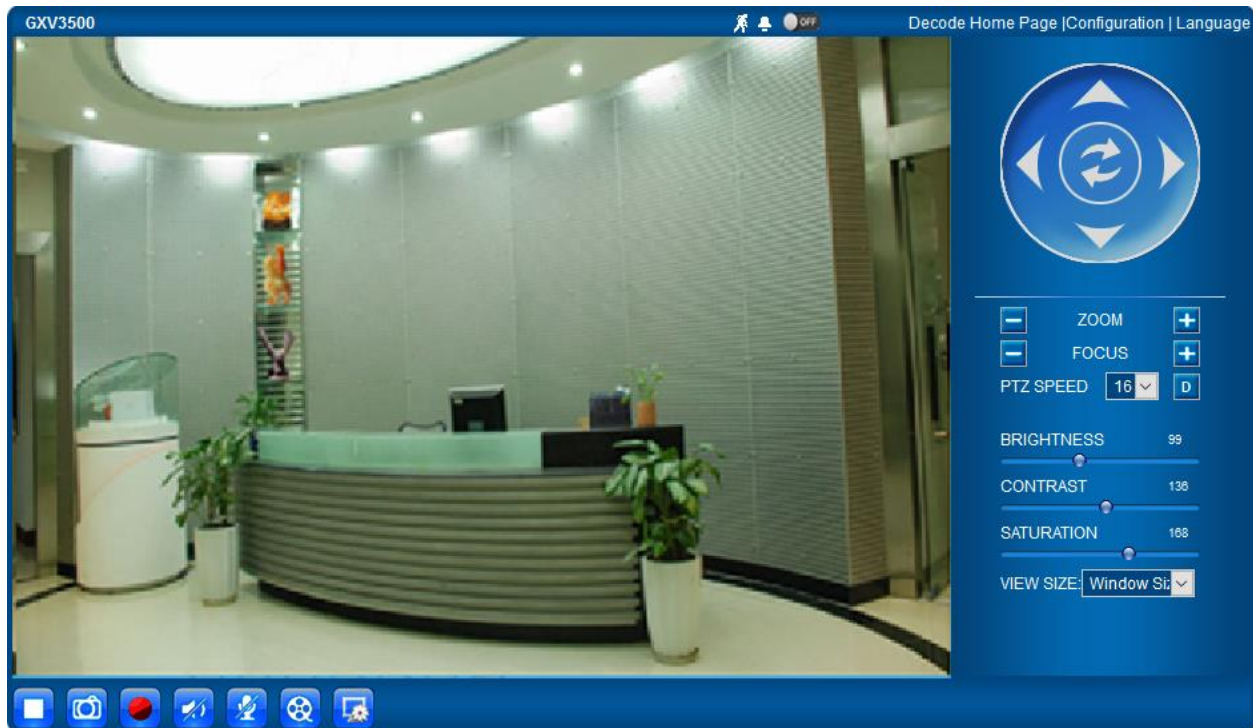

Figure 12: Home page of gxv3500 (encoder mode)

Table 3: Home page options (Encoder Mode)

View Size	Click to switch between real resolution size and embedded window size video.
ZOOM	Zoom In/Out during PTZ operation (when connected to supported camera)
BRIGHTNESS bar	Adjust the image or video brightness.
CONTRAST bar	Adjust the image or video contrast.
SATURATION bar	Adjust the image or video saturation.
Language icon	Click to switch webpage language.(Current support: Chinese, English, and Russian)
Configuration icon	Click to enter “Configuration Page” to configure the parameters of GXV3500 (Administration)
Decode Home Page	Click to switch to Decode Mode (Reboot required to take effect).
Default Video Parameter icon	Click to reset video parameters (Brightness, Contrast, and Saturation) to default.
Stop/Play Video icon	Click to Stop and Play the embedded live video.
Capture (Snapshot) icon	Click to capture and save a snapshot of current displayed video frame.



Record icon	Click to Start/Stop record of current video stream into a file. Default directory: C:\Record
Listen On/Off icon	Toggle to listen/stop audio from the camera's microphone
Listen On/Off icon	Toggle to listen/stop audio from the camera's microphone
Talk On/Off icon	Toggle to talk to camera's speaker (computer microphone required)
Playback	Click to playback the recorded video file.
Local Configuration	Click to configure the file path of snapshot and recorded video files. Also adjust the video
Motion Detection Alarm	If (configured) motion detection alarm triggered, the indicator will flash in
DI, Alarm_In icon	Indicator will be on when there is an external Alarm Input. Click the indicator icon to turn off the alarm indication.
DO, Alarm_Out icon	Click the indicator icon manually switch the Alarm_Out operation.

GXV3500 Configuration & Language Page

- When click the “Configuration” icon, web page will link to configure page related parameters of the GXV3500.
- There are two big categories of settings: **Basic Settings** and **Advanced Settings**. Details will illustrate in the following Chapters.
- When click the “Language” icon, supported languages will display in Figure 2. Click to select the related webpage display language.



Figure 13: Web language switch

- Currently firmware only support: English (default), Simplified Chinese and Russian.

Basic Settings Explanation

System Settings Page

This page allow user to configure the system settings of GXV3500.

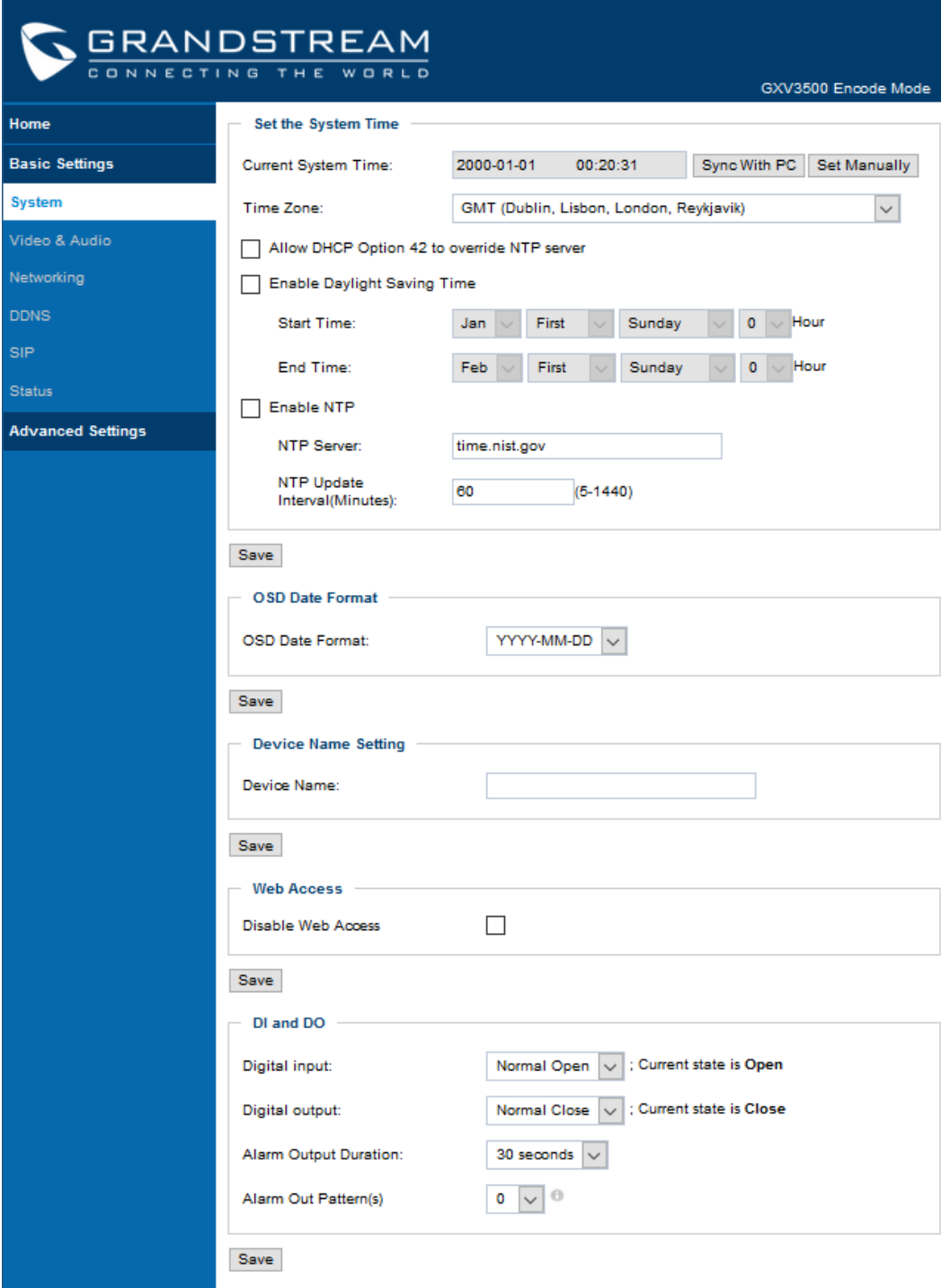

GRANDSTREAM
CONNECTING THE WORLD

GXV3500 Encode Mode

Home

Basic Settings

System

Video & Audio

Networking

DDNS

SIP

Status

Advanced Settings

Set the System Time

Current System Time: 2000-01-01 00:20:31

Time Zone: GMT (Dublin, Lisbon, London, Reykjavik)

Allow DHCP Option 42 to override NTP server

Enable Daylight Saving Time

Start Time: Jan First Sunday 0 Hour

End Time: Feb First Sunday 0 Hour

Enable NTP

NTP Server: time.nist.gov

NTP Update Interval(Minutes): 60 (5-1440)

OSD Date Format

OSD Date Format: YYYY-MM-DD

Device Name Setting

Device Name:

Web Access

Disable Web Access

DI and DO

Digital input: Normal Open ; Current state is Open

Digital output: Normal Close ; Current state is Close

Alarm Output Duration: 30 seconds

Alarm Out Pattern(s): 0 ⓘ

Figure 14: System Settings page

Table 4: System settings page options (Encoder Mode)

Current System Time	Display time current system is running at.
Sync with PC	Click to synchronize current time with computer.
Set Manually	Click to manually set the current time and date.
Time Zone	Select from pull down menu the time zone unit located.
Allow DHCP Option 42 to override NTP server	Defines whether DHCP Option 42 should override NTP server or not. When enabled, DHCP Option 42 will override the NTP server if it is set up on the LAN. The default setting is "Yes".
Enable Day Light Saving Time	Enable and Configure Day Light Saving Start Time and End Time.
Enable NTP	Enable and configure NTP server and update interval.
(On Screen Display) OSD Date Format	OSD Date format, choose based on user preference.
Device Name Setting	Set the name of the camera which will be shown in the result of "Search Tool" of GSurf_Pro VMS program.
Disable Web Access	Choose to Enable/Disable HTTP Web Access
DI and DO	DI and DO initial status for Alarm In or Out operation.
Digital Input	State of Digital Input, normal at Open state.
Digital Output	State of Digital Output, normal at Open state
DO Output Duration	Select operation of Alarm Output Duration from pull down list.
Alarm Out Pattern (s)	Configure an ON/OFF cadence during that specific duration of time which the alarm out follows when played. Range is from 0-3. Default is 0. When set to 0, no cadence will be applied and alarm out will be played continuously.

Video & Audio Setting Page

This page allows user to configure the video and audio related settings.



GRANDSTREAM
CONNECTING THE WORLD
GXV3500 Encode Mode

Home

Basic Settings

System

Video & Audio

Networking

DDNS

SIP

Status

Advanced Settings

On Screen Display(OSD)

OSD Text:

OSD Position:

Display Time:

Display Text:

Video Settings

Primary Stream Settings

Preferred Video Codec:

Resolution:

Bit Rate: kbps

Maximum Frame Rate: fps

Bit Rate Control: CBR VBR

I-frame Interval: Frame(1-100)

Secondary Stream Settings

Preferred Video Codec:

Resolution:

Bit Rate: kbps

Maximum Frame Rate: fps

Bit Rate Control: CBR VBR

I-frame Interval: Frame(1-100)

Audio Settings

Preferred Audio Codec:

Microphone Volume:

Speaker Volume:

Figure 15: Video & Audio Settings Page



Table 5: Video & Audio settings

On Screen Display (OSD)	Format to display the OSD date.
OSD Text	Input text (to identify the camera) shown on the screen.
OSD Position	Show the OSD in either top or bottom position on screen.
Display Time	When checked, time will be displayed inside the video image.
Display Text	When checked, inputted text will display on video image.
Preferred Video Codec	MJPEG and H.264 supported, H.264 recommended.
Resolution	The resolution in pixels used at video image.
Bit Rate	Video bit rate or bandwidth used.
Maximum Frame Rate	Maximum frame rate used (more data if big frame used).
Bit Rate Control	Constantly bit rate, or variable bit rate.
Image Quality	Image quality used when Variable Bit Rate used.
I-frame Interval	I-frame interval (suggested 2~3 times of frame rate).
Preferred Audio Codec	PCMU, PCMA. Audio also can be disabled.
Microphone Volume	Slide to adjust microphone gain.
Speaker Volume	Slide to adjust the speaker volume connected.

Notes:

- H.264 suggested if camera needs to be viewed via Internet.
- The definition of Baseline, Main Profile and High profile of H.264 please refer to:
- http://en.wikipedia.org/wiki/H.264/MPEG-4_AVC
- If MJPEG selected, reduce max. frame rate to min. value to save bandwidth and get better image
- Grandstream IP Camera provides two video streams, user can use them with flexibility. For example, the high-resolution stream for local recording; another low or high resolution for remote monitoring; or vice versa depending on application scenarios.
- **Use below link to calculate bandwidth and storage before installation**
<http://www.grandstream.com/support/tools/bandwidth-storage-calc>



Networking Setting Page

This page allows user to configure network related parameters:

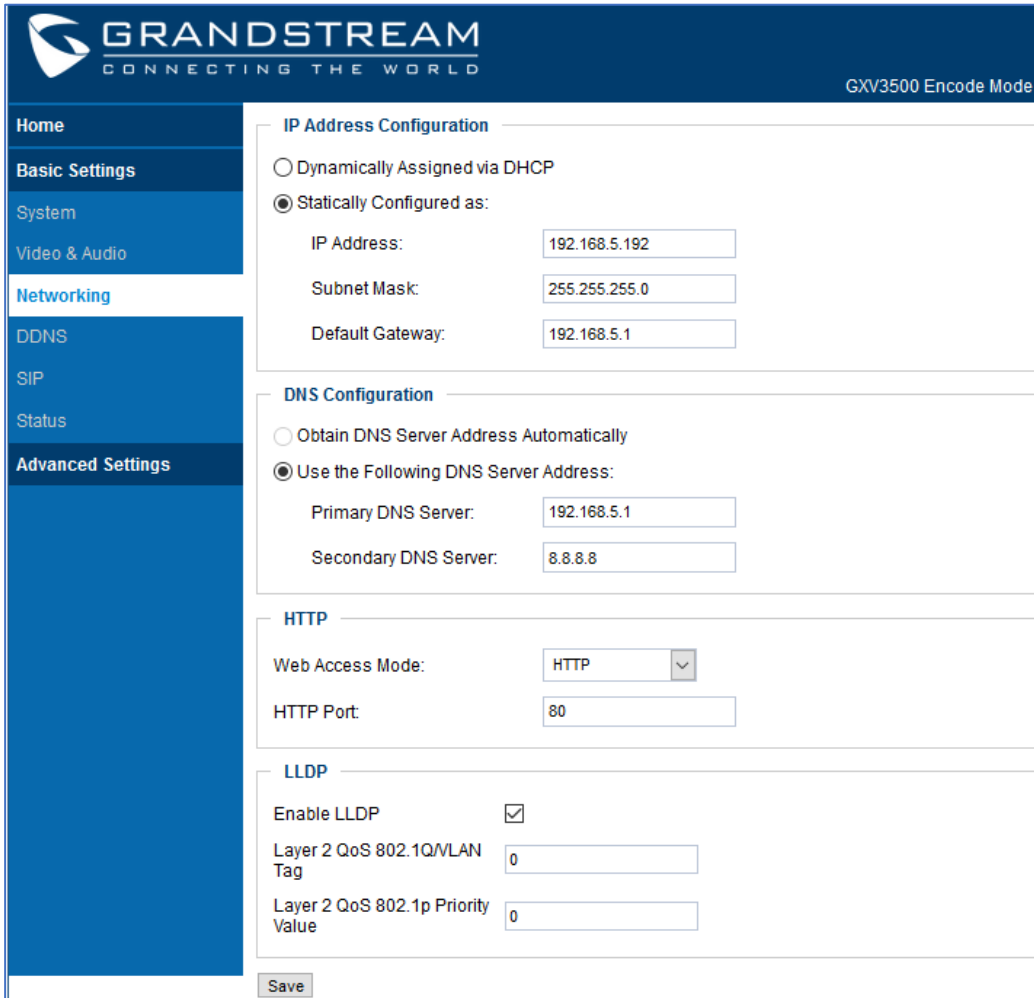

GRANDSTREAM
CONNECTING THE WORLD

GXV3500 Encode Mode

Home

Basic Settings

System

Video & Audio

Networking

DDNS

SIP

Status

Advanced Settings

IP Address Configuration

Dynamically Assigned via DHCP

Statically Configured as:

IP Address:

Subnet Mask:

Default Gateway:

DNS Configuration

Obtain DNS Server Address Automatically

Use the Following DNS Server Address:

Primary DNS Server:

Secondary DNS Server:

HTTP

Web Access Mode:

HTTP Port:

LLDP

Enable LLDP

Layer 2 QoS 802.1Q/VLAN Tag

Layer 2 QoS 802.1p Priority Value

Figure 16: Networking Setting Page

Table 6: Networking Setting

Dynamically Assigned via DHCP	Default setting, DHCP server assign IP to camera.
Statically Configured as	Static IP address configuration (Preferred for Port FWD).
DNS Configuration	DNS server IP. Must be configured if using static IP.
Web Access Mode	Selects the access mode to the web GUI either HTTP or HTTPS.
HTTP Port	Specifies the TCP port for Web Access, Default is 80.
Enable LLDP	Controls the LLDP (Link Layer Discovery Protocol) service. The default setting is "Enabled".

Layer 2 QoS 802.1Q/VLAN Tag	Assigns the VLAN Tag of the Layer 2 QoS packets. Default value is 0. Range is from 0 - 4094.
Layer 2 QoS 802.1p Priority Value	Assigns the priority value of the Layer2 QoS packets. Default value is 0. Range is from 0 - 7.

Notes:

- If camera behind SOHO router with port forwarding configuration for remote access, static IP or static DHCP has to be used to avoid IP address change after router reboot.
- TCP port above 5000 suggested if Port Forward HTTP for remote access, due to some ISP would block port 80 for inbound traffic. For example, change the default HTTP port from 80 to 8088, to make sure the TCP port not likely blocked.
- In addition to HTTP port, RTSP port is also required to configure via port forward, so remote party can view the video stream.
- If revise the default TCP port 80 to port “A”, then RTSP port should be “2000+A” (changed from default TCP 554). Both TCP port “A” and “2000+A” should be configured for port forwarding in the router. For example, the HTTP port changed to 8088, the RTSP port now should be 10088, both TCP ports 8088 and 10088 should be configured for port forwarding in order for remote camera access: 8088 for web portal, 10088 for video streaming.

DDNS Settings Page

This page allows user to configure dynamic DNS related parameters:

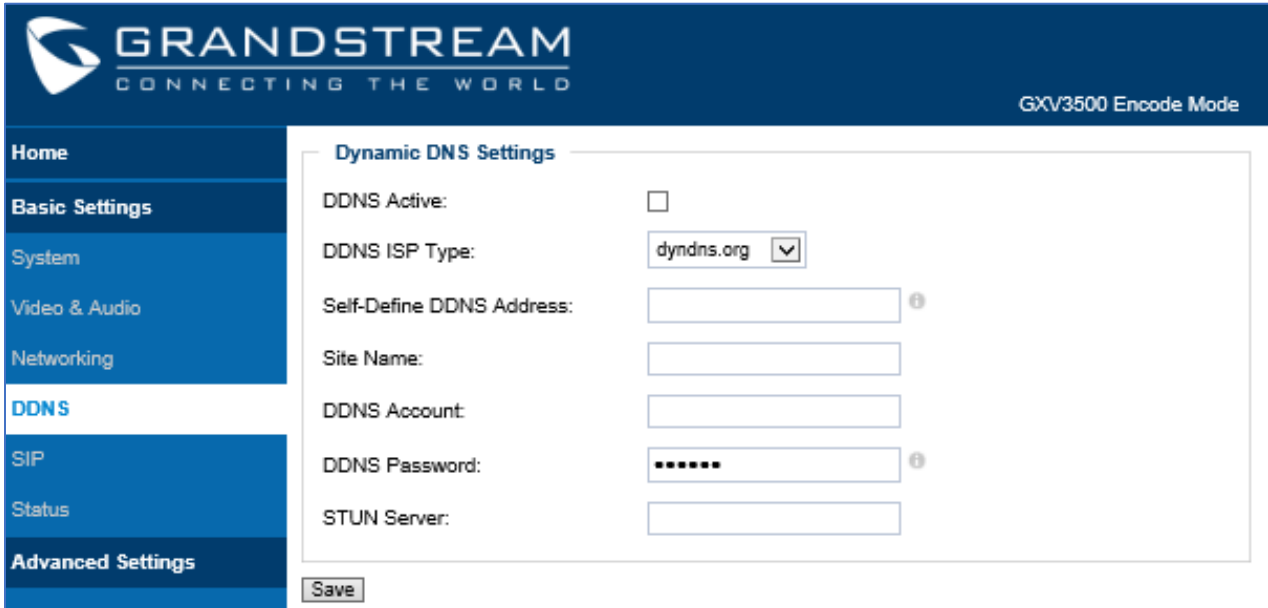

Figure 17: DDNS Setting Page

Table 7: DDNS Setting

DDNS Active	Enable DDNS by check this field.
DDNS ISP Type	Select the DDSN service provider from the pull-down menu list.
Self-Define DDNS Address	Input the self-defined DDNS address.
Site Name	DDNS site name.
DDNS Account	DDNS account name.
DDNS Password	DDNS password.
STUN Server	Stun server FQDN or IP. If device behind a non-symmetric router, STUN server can help to penetrate & resolve NAT issue.



SIP Setting Page

GXV3500 can be configured as SIP endpoint to call out when alarm triggered or allow permitted number to call in to check the audio/video if Grandstream IP videophone used.

Home	General Phone Settings Registered: Offline Unregister On Reboot: <input type="checkbox"/>
Basic Settings	SIP Settings Account Name: <input type="text"/> ⓘ SIP Server: <input type="text"/> ⓘ Outbound Proxy: <input type="text"/> ⓘ SIP User ID: <input type="text"/> ⓘ Authenticate ID: <input type="text"/> ⓘ Authenticate Password: <input type="password"/> ⓘ STUN Server: <input type="text"/> ⓘ Stream: Secondary ▼ Preferred Vocoder 1: PCMU ▼ Preferred Vocoder 2: PCMA ▼ Voice Frames Per TX: <input type="text" value="2"/> ⓘ Register Expiration(Second): <input type="text" value="3600"/> ⓘ Re-register before Expiration(s): <input type="text" value="0"/> ⓘ Special Feature: Standard ▼ NAT Traversal: No ▼ Local SIP Port: <input type="text" value="5060"/> ⓘ Local RTP Port: <input type="text" value="5004"/> ⓘ Use Random Port: <input type="checkbox"/> Auto On-Hook Timer: <input type="text" value="300"/> ⓘ Disable Audio in SIP Call: <input type="checkbox"/> ⓘ Enable Keep Alive: <input type="checkbox"/> Accept Direct IP Call: <input checked="" type="checkbox"/> Enable White List Number Filter: <input type="checkbox"/> ⓘ Enable two-way SIP Calling: <input checked="" type="checkbox"/> ⓘ SIP Proxy Compatibility Mode: <input type="checkbox"/> ⓘ Answer Mode: Auto Answer ▼ Ring Timeout(s): <input type="text" value="30"/> ⓘ DNS Mode: A Record ▼ Self-defined Warning Audio: <input type="button" value="Upload"/> <input type="button" value="Delete"/> Audio Out Ringtone: <input type="button" value="Upload"/> <input type="button" value="Delete"/>
System	
Video & Audio	
Networking	
DDNS	
SIP	
Status	
Advanced Settings	

Figure 18: SIP Setting Page (part 1)

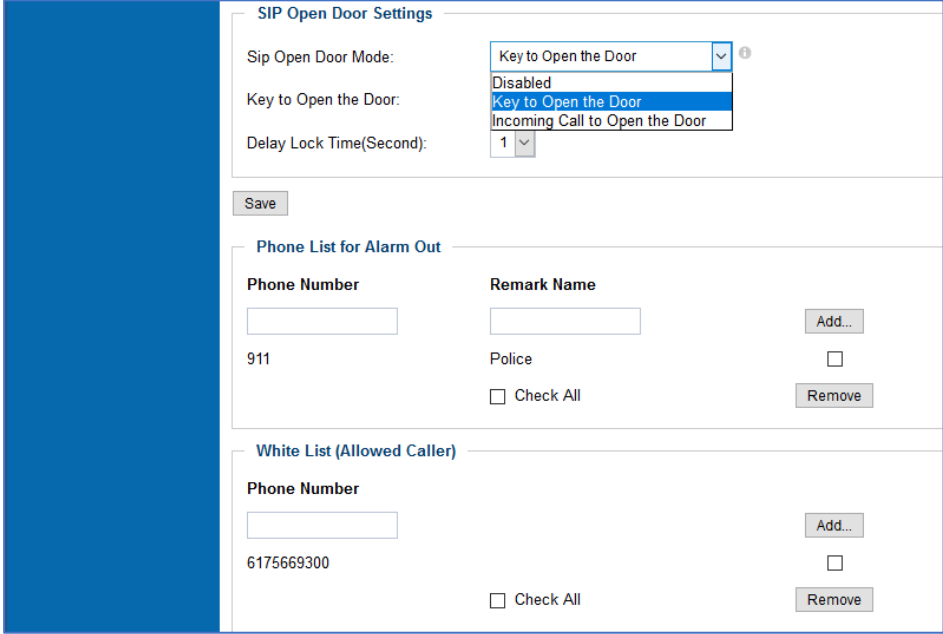

The screenshot displays the SIP configuration interface. The top section, 'SIP Open Door Settings', includes a dropdown for 'Sip Open Door Mode' (set to 'Key to Open the Door'), a 'Key to Open the Door' dropdown (also set to 'Key to Open the Door'), and a 'Delay Lock Time(Second)' dropdown (set to '1'). A 'Save' button is located below these settings. The middle section, 'Phone List for Alarm Out', features a table with columns for 'Phone Number' and 'Remark Name'. It contains one entry for '911' with the remark 'Police'. There are 'Add...', 'Remove', and 'Check All' buttons. The bottom section, 'White List (Allowed Caller)', has a similar table with one entry for '6175669300' and the same control buttons.

Figure 19: SIP Setting Page (part 2)

Table 8: SIP Setting

Registered	SIP registration status. Display “Online” in Green, “Offline” in Red.
Unregistered on Reboot	If checked and SIP server support, reboot camera will unbind all registered end points using this SIP account.
Account Name	SIP account name used for self-identification.
SIP Server	FQDN or IP of SIP server from VoIP service provider
Outbound Proxy	IP or FQDN of Outbound proxy server, helps penetrate NAT/Firewall
SIP User ID	SIP username, or telephone number from ITSP.
Authenticate ID	Authenticate ID used by SIP proxy
Authenticate Password	Authenticate password used by SIP proxy
STUN Server	STUN server used to resolve NAT if have
Stream	Which stream used for SIP call. Default 2nd stream, strongly recommended due to bandwidth and data involved at video call.
Preferred Vocoder 1	Audio codec used for SIP call, only G.711 A or U supported.
Preferred Vocoder 2	Audio codec used for SIP call, only G.711 A or U supported.
Voice Frame Per TX	Configures the number of voice frames transmitted per packet. When configuring this, it should be noted that the “ptime” value for the SDP will change with different configurations here. This value is related to the codec used and the actual frames transmitted during



	<p>the in-payload call. For end users, it is recommended to use the default setting, as incorrect settings may influence the audio quality.</p> <p>The default setting is 2. Range is from 1-64.</p>
Registration Expiration (s)	Registration expiration time, default 3600 seconds.
Re-Register before Expiration (s)	<p>Specifies the time frequency (in seconds) that the GXV3500 sends re-registration request before the Register Expiration. The default value is 0.</p> <p>Range is from 0-64800 seconds.</p>
Local SIP Port	Local SIP port, default 5060
Local RTP Port	Local RTP port for media, default 5004
Use Random Port	<p>Forces the GXV3500 to use random ports for both SIP and RTP messages. This is usually necessary when multiple units are behind the same full cone NAT. The default setting is “Disabled”.</p> <p>Note: This parameter must be set to “Disabled” for Direct IP Calling to Work.</p>
Auto On-Hook Timer	Timer (in seconds) for automatic disconnecting the SIP call. Default 300.
Disable Audio in SIP Call	Disable or turn off audio of camera when SIP call established.
Enable Keep Alive	Checked to help NAT resolution, sending alive packets.
Accept Direct IP Call	Check to accept peer-to-peer IP call in LAN without SIP server.
Enable White List Number Filter	Check to allow only white list number to call in, for security.
Enable two-way SIP Calling	Check to enable two-way audio when call established (Default)
SIP Proxy Compatibility Mode	Check to enable more proxy compatibility with cost of bandwidth, the SIP call will send both audio and video no matter what.
Answer Mode	<p>User can either select:</p> <p>Auto-Answer: The GXV3500 will answer immediately incoming call.</p> <p>Ring: The GXV3500 will ring until reaching the configured Ring Timeout.</p> <p>Auto-Answer After Ring Timeout: The GXV3500 will ring until reaching the configured Ring Timeout then call will be auto answered.</p>
Ring Timeout (s)	<p>Pulldown selection of Ring Timeout timer in seconds. Range: 15-300 seconds. Default is 30 seconds.</p>
DNS Mode	<p>Selects DNS mode to use for the client to look up server.</p> <ul style="list-style-type: none"> • A Record: resolves IP Address of target according to domain name.



	<ul style="list-style-type: none"> • SRV: DNS SRV resource records indicate how to find services for various protocols. • NAPTR/SRV: Naming Authority Pointer according to RFC2915. <p>Default is A Record.</p>
Self-Defined Warning Audio	<p>Upload the correct formatted self-defined warning audio.</p> <p>Upload self-defined alarm warning message audio. (Format: G.711A, G711M format, File Size <= 300KB, Linear PCM, 8KHz Sampling Rate, 16bit, Single Channel)</p>
Audio Out Ringtone	<p>Upload the correct formatted audio out ringtone.</p>
SIP Open Door Mode	<p>Pulldown selection of three mode: Disabled, Key to Open the Door and Incoming Call to Open the Door</p> <ul style="list-style-type: none"> • Key to Open the Door: DTMF password configured when call established to open door , • Incoming Call To Open the door: Alarm out will be triggered once call is received by the GXV3500. • Delay Lock Time: Timer (in seconds) for relay/lock to recover. (Default is 1 second)
Phone List for Alarm Out	<p>Callee or receiver's number when alarm call trigged.</p>
White List (Allowed Caller)	<p>Phone numbers allowed calling into the camera.</p>

Notes:

- When selected, this feature will override any existing Alarm Out (like Alarm In triggered Alarm Out, or Motion Detection triggered Alarm Out).
- The Alarm Out Port has to connect to Electric Door Strike or Relay to control door open/close.
- Remote SIP phone needs key in password (**digits 0-9 only, ended with # key**) matching the configuration here to open the door. (via DTMF)



Status Page

This page shows the GXV3500 operation status:

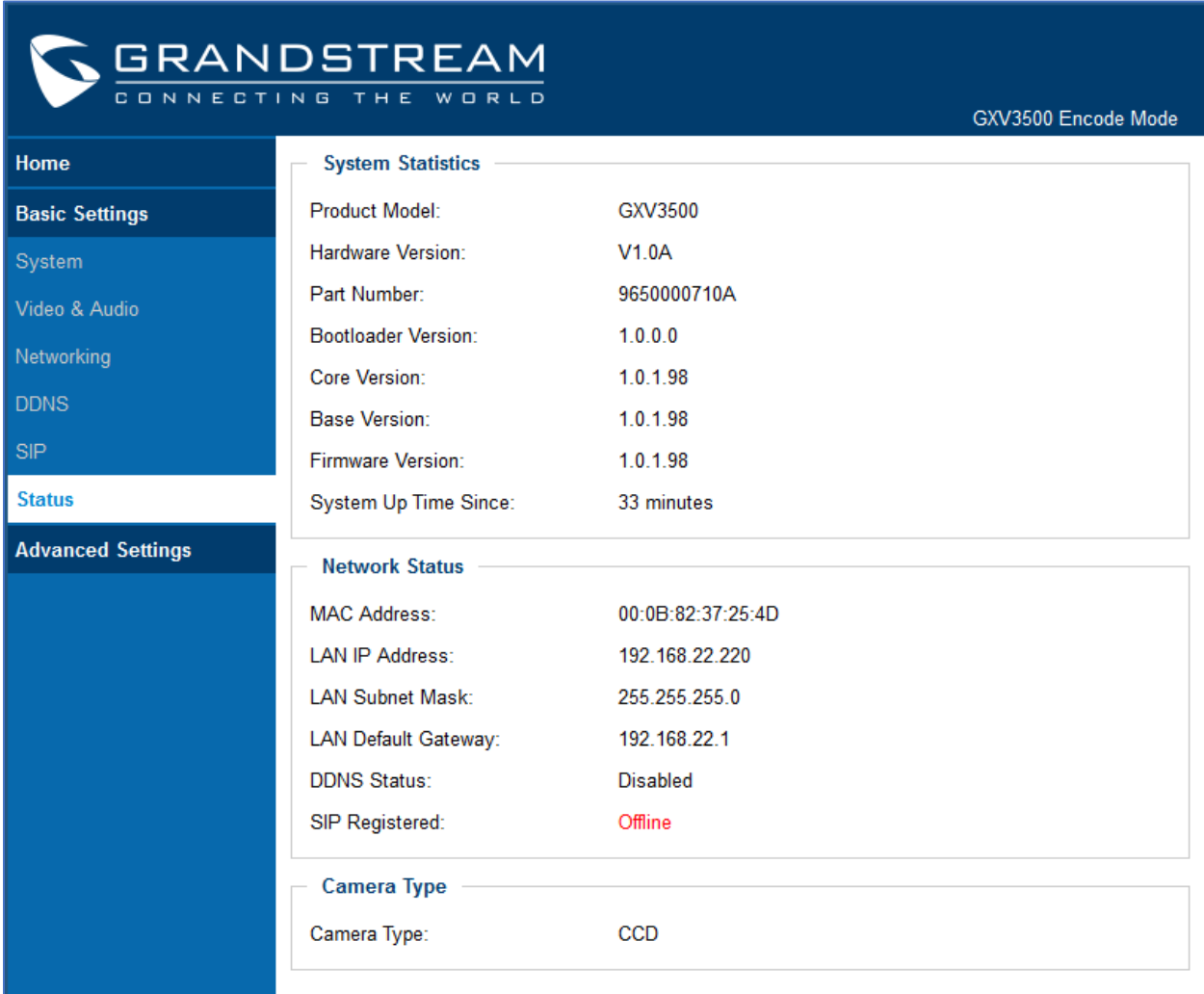

System Statistics	
Product Model:	GXV3500
Hardware Version:	V1.0A
Part Number:	9650000710A
Bootloader Version:	1.0.0.0
Core Version:	1.0.1.98
Base Version:	1.0.1.98
Firmware Version:	1.0.1.98
System Up Time Since:	33 minutes

Network Status	
MAC Address:	00:0B:82:37:25:4D
LAN IP Address:	192.168.22.220
LAN Subnet Mask:	255.255.255.0
LAN Default Gateway:	192.168.22.1
DDNS Status:	Disabled
SIP Registered:	Offline

Camera Type	
Camera Type:	CCD

Figure 20: Status Page

Notes:

- When SIP account registered, the status will display “Online” in Green.
- When SIP account unregistered, the status will display “Offline” in Red, as below.

SIP Registered: **Offline**

Advanced Settings Explanation

User Management Page

This page allows user to do user management:



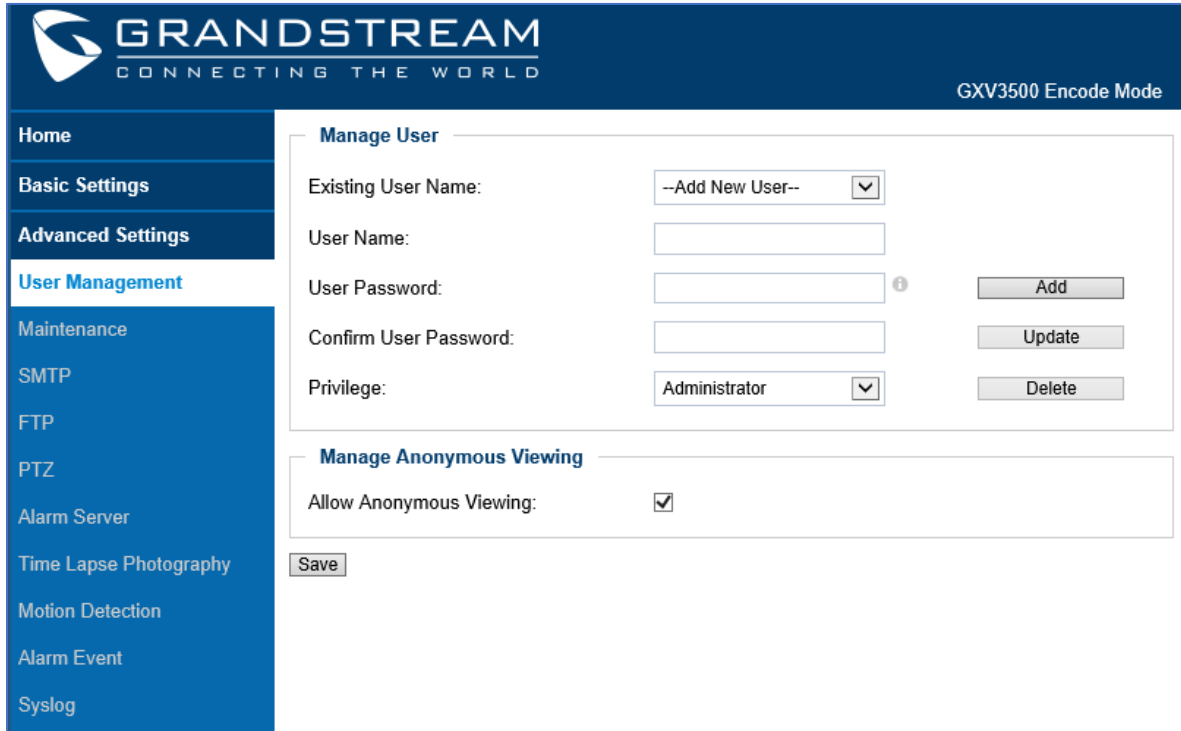

Figure 21: User Management Page

Table 9: User Management page

Existing User Name	Allow revise existing user or add new user.
User Name	The name of users need to be revised.
User Password	New password if revise password.
Confirm User Password	Re-enter the new password for verification, must match.
Privilege	Server path holding the configuration file (auto provisioning).
Allow Anonymous Viewing	When checked, no security enhanced. Any person can view the camera if knowing the IP or FQDN of the camera, but cannot change anything, just view ONLY.

Maintenance Page

This page allows user to maintain the camera:

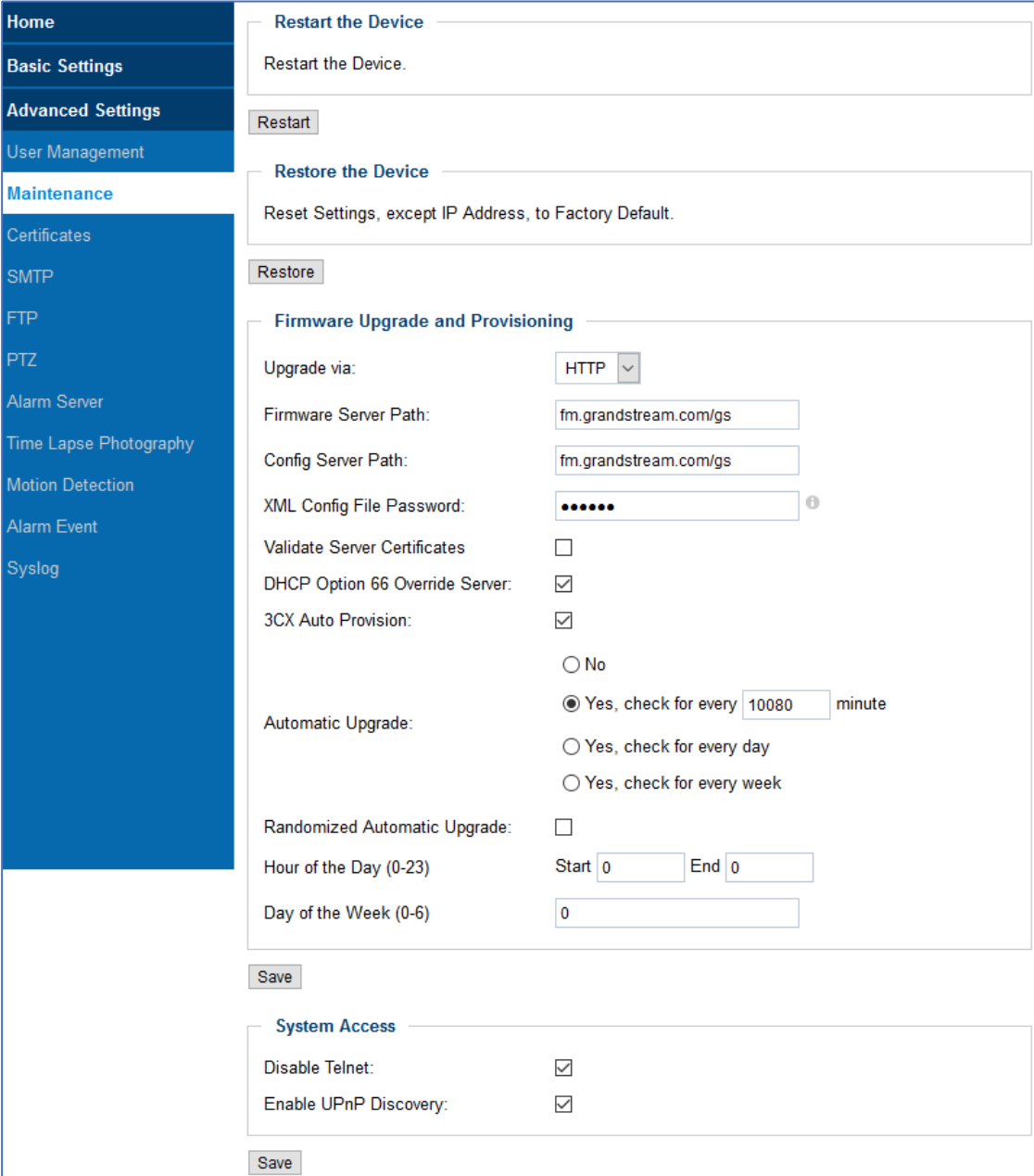

Figure 22: Maintenance page

Table 10: User Management page

Restart	When clicked, the GXV3500 will reboot or restart (soft reboot).
Restore	When clicked, the camera will be reset to factory default, wiping out all the configurations (except IP address).
Upgrade via	Firmware upgrade via TFTP, HTTP or HTTPS.



Firmware Server Path	Sets IP address or domain name of firmware server. The URL of the server that hosts the firmware release. Default is "fm.grandstream.com/gs". Note: Make sure to not prepend address with "http://" or any other protocol
Config Server Path	Sets IP address or domain name of configuration server. The server hosts a copy of the configuration file to be installed on the GXV3500. Default is "fm.grandstream.com/gs". Note: Make sure to not prepend address with "http://" or any other protocol.
XML Config File Password	Password for encrypt the XML based configuration file.
Validate Server Certificates	Enable this option in order to validate certificate with trusted ones during TLS connection.
DHCP Option 66 Override Server	If DHCP option 66 is checked, the GXV3500 will attempt to download firmware file and XML config file from the server URL provided by DHCP overriding configured Firmware Server Path and Provisioning Server Path (even if left blank).
3CX Auto Provision	Enable or disable the 3CX PnP Auto Provision. When enabled, the GXV3500 to broadcast the SIP SUBSCRIBE message during booting up to allow itself to be discovered and be configured by the SIP platform. The default setting is "Yes".
Automatic Upgrade	Checked to enable automatic firmware upgrade and provisioning.
Randomized Automatic Upgrade	Randomized Automatic Upgrade within the range of hours of the day or postpone the upgrade every X minute(s) by random 1 to X minute(s).
Disable Telnet	Check to disable Telnet to enhance security.
Enable UPnP Discovery	Used for UPnP automatic discovery of the device in related network environment. Default enabled.

Note:

- Only XML based automatic provisioning is supported by GXV3500.

Certificates Page

This page allows users to upload up to 6 Trusted CA certificate files which will be trusted by the GXV3500 during SSL exchange.

Also users are allowed to configure the device with custom certificate signed by custom CA certificate under the Custom Certificate section.



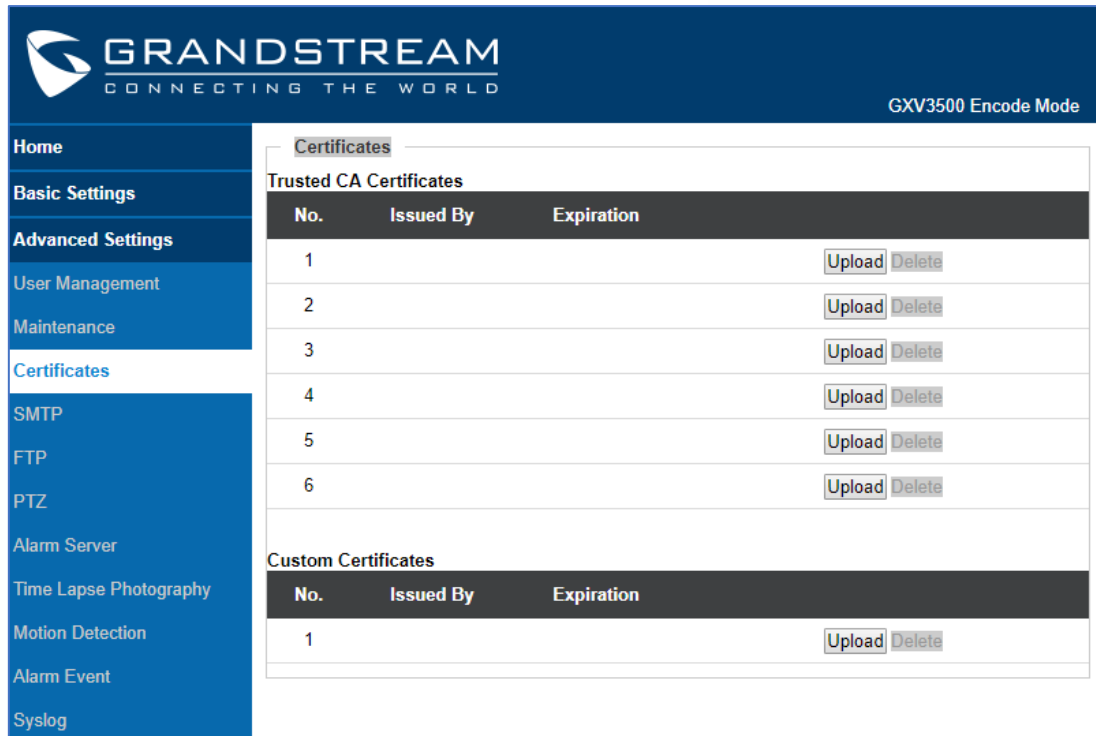

Figure 23: Certificates page

In order to upload your Trusted CA certificate:

Click on **Upload** button to upload a file and some related information to the uploaded file will be displayed, such as **“Issued by”** and **“Expiration”**.

Trusted CA Certificates			
No.	Issued By	Expiration	
1	-	2021-12-11 11:33:00	Upload Delete

User could press **Delete** to delete one of the files.

In order to upload your Custom certificate:

Click on **Upload** button to upload a file and some related information to the uploaded file will be displayed, such as **“Issued by”** and **“Expiration”**.

Custom Certificates			
No.	Issued By	Expiration	
1			Upload Delete

User could press **Delete** to delete one of the files.

SMTP Setting Page (Email Alarm)

This page allows user to configure email client to send out email when alarm triggered:

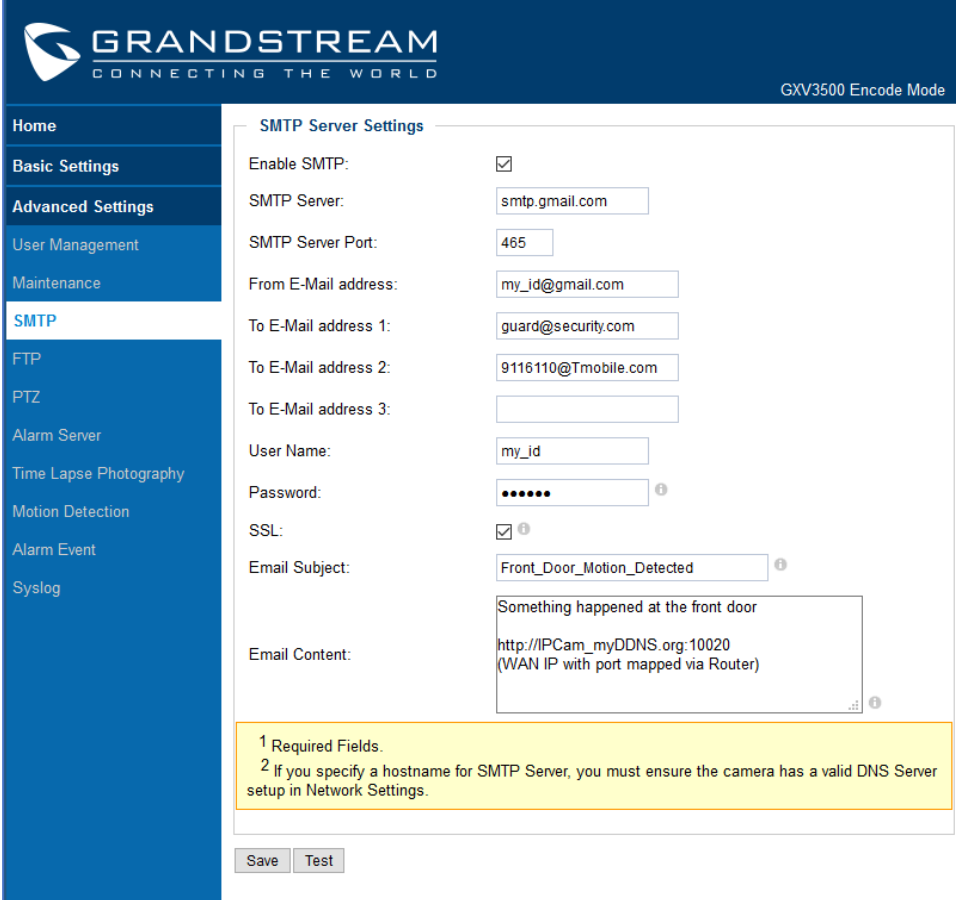

Figure 24: SMTP page

Table 11: SMTP page

Enable SMTP	When checked will enable email client.
SMTP Server	SMTP Email Server IP or Domain Name.
SMTP Server Port	Port number used by server to send email.
From Email address	The email address of alarm email sending from, usually client email ID.
To E-Mail address	The email address to receive the alarmed email, total 3 can be configured.
User Name	Email client User ID.
Password	Email client password.
SSL	Check if the SMTP email server requires SSL.
Email Subject	Customizable email subject for user's convenience.
Email Content	Customizable email content for user's purpose.



Notes:

- Click “Save” to save the email configuration information.
- Click “Test” after configuration, if setting is correct, a test email will send out and “Test successful!” orange bar will display:

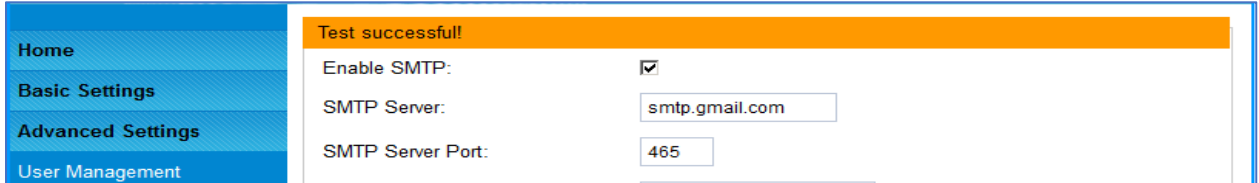

Home	Test successful!	
Basic Settings	Enable SMTP:	<input checked="" type="checkbox"/>
Advanced Settings	SMTP Server:	<input type="text" value="smtp.gmail.com"/>
User Management	SMTP Server Port:	<input type="text" value="465"/>

FTP Settings Page (Upload Alarm)

This page allows user to configure FTP parameters to upload the alarm or video recording:

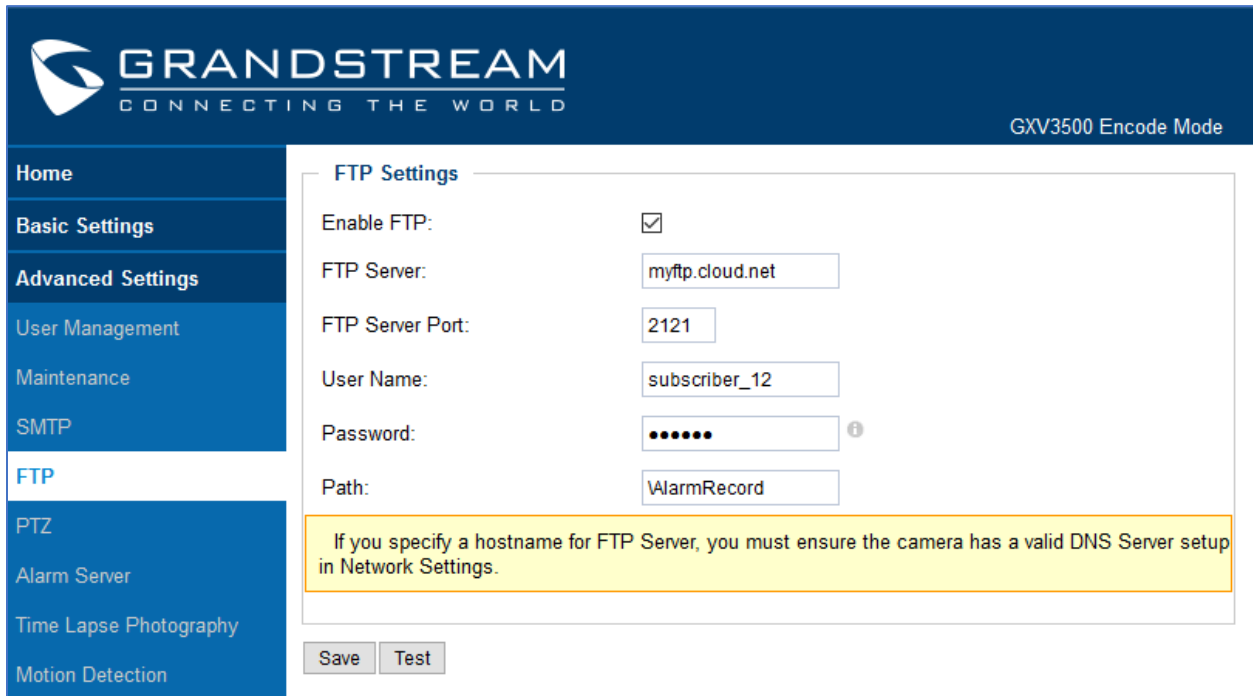

Home	GXV3500 Encode Mode	
Basic Settings	FTP Settings	
Advanced Settings	Enable FTP:	<input checked="" type="checkbox"/>
User Management	FTP Server:	<input type="text" value="myftp.cloud.net"/>
Maintenance	FTP Server Port:	<input type="text" value="2121"/>
SMTP	User Name:	<input type="text" value="subscriber_12"/>
FTP	Password:	<input type="password" value="....."/>
PTZ	Path:	<input type="text" value="AlarmRecord"/>
Alarm Server	If you specify a hostname for FTP Server, you must ensure the camera has a valid DNS Server setup in Network Settings.	
Time Lapse Photography	<input type="button" value="Save"/> <input type="button" value="Test"/>	
Motion Detection		

Figure 25: FTP Settings Page

Table 12: FTP Settings page

Enable FTP	When checked will enable built-in FTP client.
FTP Server	IP or Domain name of FTP site or server.
FTP Server Port	TCP port for FTP server, default port number 21.
User Name	FTP server User ID.
Password	FTP server user password.
Path	Path in the server where upload files are stored or saved.

Notes:

- Click “Save” to save the FTP configuration information.
- Click “Test” after configuration, if setting is correct, a test FTP operation will be performed and “Test successful!” orange bar will display if the operation is successful, like: Test successful!

PTZ

This page allows user to configure PTZ parameters if the connected analogue camera support Pelco-D or Pelco-P protocol.

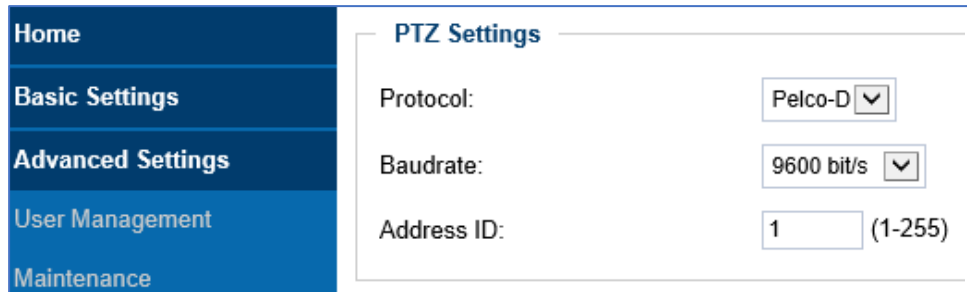

Figure 26: PTZ Setting Page

Table 13: PTZ Settings page

Protocol	Pull-down to select supported PTZ protocol by connected analogue camera. Only Pelco-D or Pelco-P allowed.
Baudrate	The baudrate used by the analogue camera interface, select from the pull-down menu.
Address ID	Hardware Pelco-D or Pelco-P address ID used by the analogue camera, please refer to related camera user manual for this ID (or PIN switch in the UM), then fill in related matching address into this field.

Note:

- The address ID filled here has to be same and match the one used in the connected analogue camera. Otherwise the PTZ will not function or behave abnormal due to the wrong Pelco-D or Pelco-P address used.

Alarm Server Settings Page

This page allows user to configure alarm HTTP server to upload alarms (Upload Alarms to VMS platform supported or HTTP Server for processing)

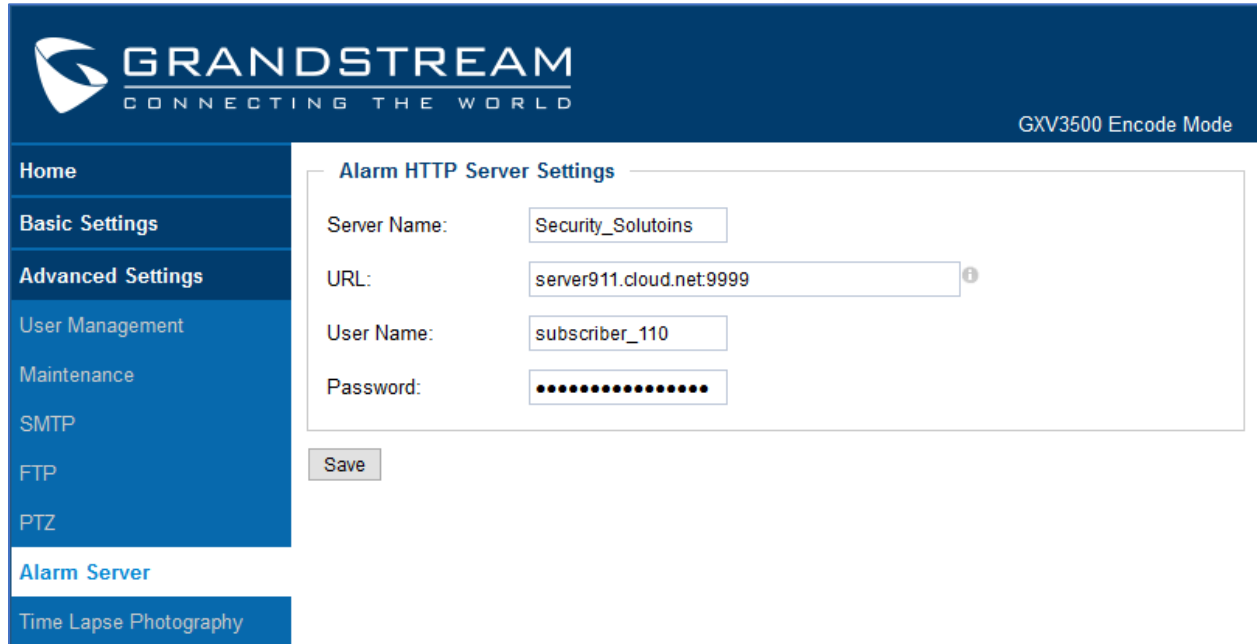

Figure 27: Alarm HTTP Server Setting Page

Table 14: Alarm HTTP Server Settings

Server Name	The name of HTTP server or VMS system
URL	URL of the Server
User Name	User ID from that Server
Password	Password for that User ID

Notes:

- Grandstream provide HTTP API to help third party companies by using HTTP server or VMS to develop further solutions for their customers.
http://www.grandstream.com/products/surveillance/general/documents/grandstream_http_api.pdf
- Grandstream IP Camera and Encoder (include GXV3500) are ONVIF certified.

Time Lapse Photography

This page allows user to configure Time Lapse Photography (or period snapshot).

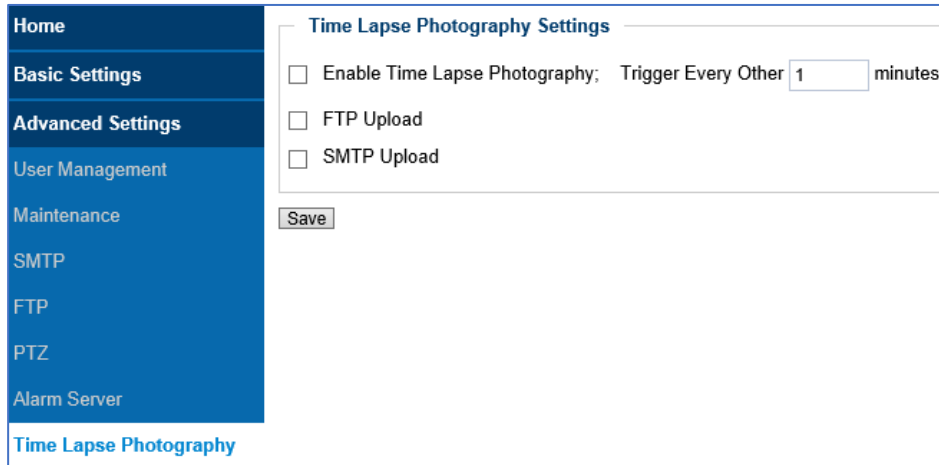

Figure 28: Time Lapse Photography Configuration Page

Table 15: Time Lapse Photography Configuration

Enable Time Lapse Photography	Check to enable this feature. User can configure the timer or duration of the triggering moment; minimum value is 1 minute.
FTP Upload	Enabled will allow device to upload the snapshots to FTP server. The FTP server is configured at “FTP” server page illustrate before.
SMTP Upload	Enabled will allow device to email the snapshots via email server. The email server is configured at “SMTP” configuration page.

Click “Save” button to save the changes made and the feature will take effect immediately.

Motion Detection

This page allows user to configure motion detection to trigger alarms:

Home

Basic Settings

Advanced Settings

User Management

Maintenance

SMTP

FTP

PTZ

Alarm Server

Time Lapse Photography

Motion Detection

Alarm Event

Syslog

Motion Detection Settings

Motion detection will be disabled if both primary and secondary codec are set to MJPEG

Show Regions

Enable Motion Detection

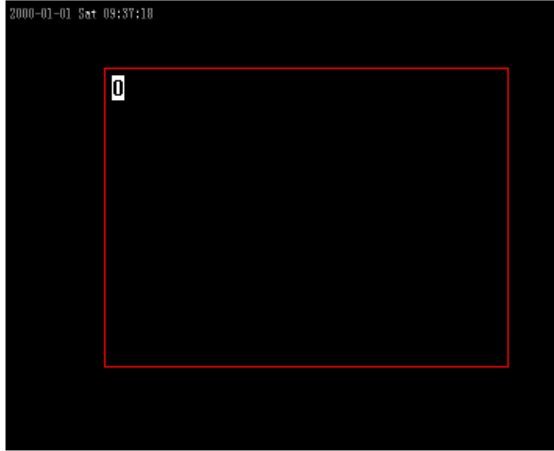

Region ID	Sensitivity
0	50
1	50
2	50
3	50
4	50
5	50
6	50
7	50
8	50
9	50
10	50
11	50
12	50
13	50
14	50
15	50

Alarm Action

Record Video From Pre Alarm Up to seconds to After Alarm Up to seconds ⓘ

Voice Alarm to SIP Phone

Alarm Output

Upload to Alarm Center

Upload to Alarm HTTP Server

Email and FTP upload JPEG and Store it to SD driver

Pre Alarm Up to seconds to After Alarm Up to seconds

Motion Detection Time Schedule

Region ID	Date	Start Time	End Time	
<input type="text" value="0"/>	Everyday	<input type="text" value="00:00"/>	<input type="text" value="23:59"/>	<input type="button" value="Add"/>

Figure 29: Motion Detection Configuration Page

Table 16: Motion Detection Configuration

Show Regions	When checked, Motion Detection region with number will be displayed as a white rectangle in the screen. When “Edit” clicked, the Rectangle will become Red.
Enable Motion Detection	When checked, Motion Detection is enabled.
Record Video From Pre	This setting to allow configure pre/post alarm video for applications to utilize.



Alarm up to XXX seconds to After Alarm Up to XXX seconds	MJPEG is NOT supported for this feature.
Voice Alarm to SIP Phone	If a SIP server or peer IP device configured, check this will allow MD event to trigger alarm SIP call to pre-configured number.
Alarm Output	Select will allow MD to send alarm to Alarm Output interface.
Upload to Alarm Center	When checked, the alarm video will be transferred to Alarm Center, like Grandstream free GSurf_Pro VMS software, or other 3rd party Alarm Center.
Upload to Alarm HTTP Server	When checked MD alarm will be send to 3rd party HTTP server via programmed Grandstream HTTP API.
Email and FTP upload JPEG	When checked, snapshots of trigger moment will be emailed to pre-configured email account and also uploaded to FTP server if configured. The pre/post alarm snapshot numbers can be configured based on time (in second) to meet user's requirement.

Motion Detection Time Schedule:

Click the “ + ” will expand the following interface to allow user to configure the Time Schedule for related Motion Detection region to take action.

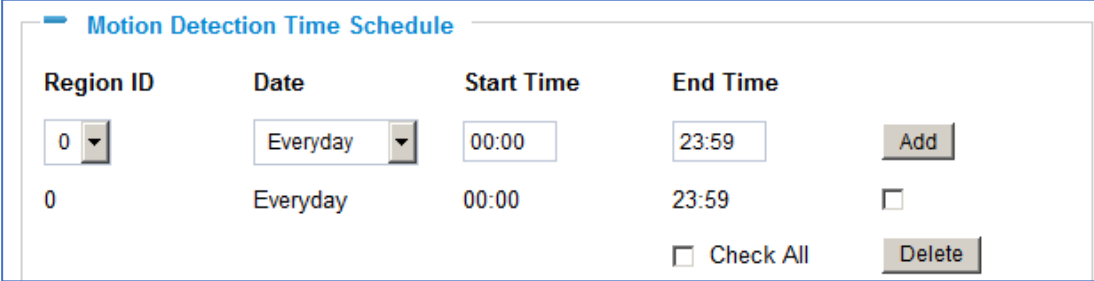

The screenshot shows a configuration interface titled "Motion Detection Time Schedule". It features a table with columns: Region ID, Date, Start Time, and End Time. The first row shows Region ID 0, Date Everyday, Start Time 00:00, and End Time 23:59. There is an "Add" button to the right of the first row. Below the table, there is a "Check All" checkbox and a "Delete" button.

Region ID	Date	Start Time	End Time	
0	Everyday	00:00	23:59	Add
0	Everyday	00:00	23:59	<input type="checkbox"/>

Check All

Figure 30: Motion Detection Schedule Configuration Page

Notes:

- As shown in Figure above, user can configure the Motion Detection Region with related Start and Stop time to control the motion detection operation.
- There are total 16 regions be available for MD configuration, from region 0 to 15.
- Select and highlight the number of regions to configure the MD and the sensitivity.
- User has to configure the “Time Schedule”; otherwise the Motion Detection Alarm will not work if there is no time schedule configured.
- Grandstream free GSurf_Pro V2 VMS software can be downloaded from:
http://www.grandstream.com/sites/default/files/Resources/GSurf_Pro_V2_1.0.3.19.zip

Alarm Event

This page allows user to configure the Alarm_In event and related actions.

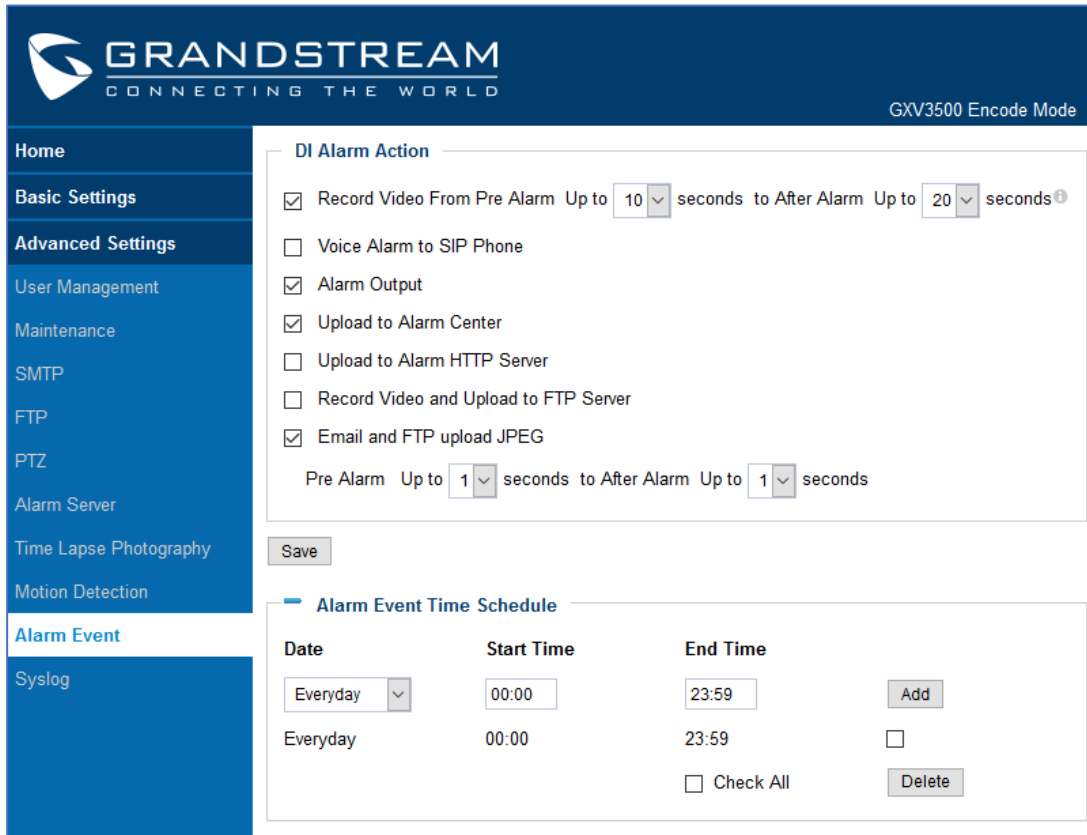

DI Alarm Action

Record Video From Pre Alarm Up to 10 seconds to After Alarm Up to 20 seconds

Voice Alarm to SIP Phone

Alarm Output

Upload to Alarm Center

Upload to Alarm HTTP Server

Record Video and Upload to FTP Server

Email and FTP upload JPEG

Pre Alarm Up to 1 seconds to After Alarm Up to 1 seconds

Save

Alarm Event Time Schedule

Date	Start Time	End Time	
Everyday	00:00	23:59	Add
Everyday	00:00	23:59	<input type="checkbox"/>
			<input type="checkbox"/> Check All Delete

Figure 31: Alarm_In Action Configuration Page

Table 17: Alarm_In Action Configuration

Pre/Post Alarm Recording (Record Video From Pre Alarm Up to XXX to After Up to XXX)	Depending on 1st stream resolution, this allows internal buffer to store the pre/post alarm video for applications to utilize.
Voice Alarm to SIP Phone	Enabled will allow device to make SIP call after receiving Alarm_In. See below NOTE for example.
Alarm Output	Enabled will allow Alarm Output after receiving Alarm_In signal.
Upload to Alarm Center	Upload to alarm center like 3rd party VMS system.
Upload to Alarm HTTP Server	Upload to 3rd party HTTP server or application using HTTP API.
Record Video and Upload to FTP Server	Upload video recording to pre-configured FTP server.
Email and FTP upload JPEG	JPEG snapshot are sent via Email and uploaded through FTP when alarm is triggered.

- Click “Save” to save the settings. Following bar will display if operation successful. Save successful!

Notes:

- Voice Alarm to SIP Phone: Application example: Intercom System, press button as Alarm_In, the pre-programmed SIP number or peer IP device will be called. If the receiver is Grandstream Video phone, the callee can use DTMF PIN code to operate and Open Door.
- MJPEG is NOT supported for this feature.**

Alarm Event Time Schedule:

Click the “Alarm Event Time Schedule” will bring up following interface to allow user to configure the Time Schedule for the Alarm_In to take action.

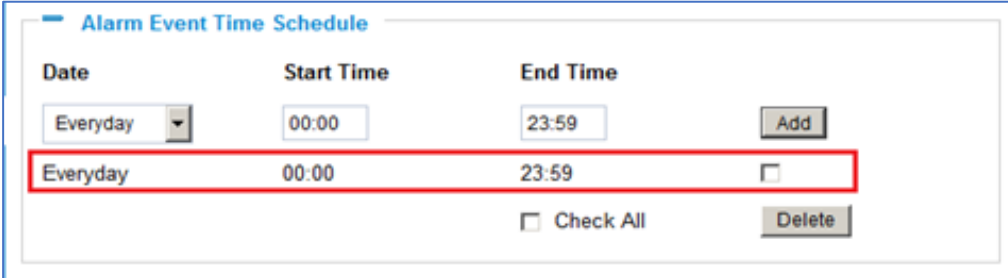

Date	Start Time	End Time	
Everyday	00:00	23:59	<input type="button" value="Add"/>
Everyday	00:00	23:59	<input type="checkbox"/>
			<input type="checkbox"/> Check All <input type="button" value="Delete"/>

Figure 32: Alarm Event Time Schedule Configuration Page

Note:

- User has to configure the “Alarm Event Time Schedule”; otherwise the Alarm In interface will not work if there is no time schedule configured.

Syslog Settings

This page allows user to enable the Syslog to help troubleshooting problems.

Home

Basic Settings

Advanced Settings

User Management

Maintenance

SMTP

FTP

PTZ

Alarm Server

Time Lapse Photography

Motion Detection

Alarm Event

Syslog

SysLog Settings

Syslog Server:

Syslog Level:

None

Debug

Info

Warning

Error

Figure 33: Syslog setting page

Table 18: Syslog settings

Syslog Server	Syslog server IP or Domain Name
Syslog Level	Lever of syslog message sent to the syslog server: None, Debug, Info, Warning, Error.

SOFTWARE UPGRADE

This page allows user to configure firmware upgrade:

Software upgrade can be done via TFTP, HTTP or HTTPS. The corresponding configuration settings are in the ADVANCED SETTINGS configuration page.

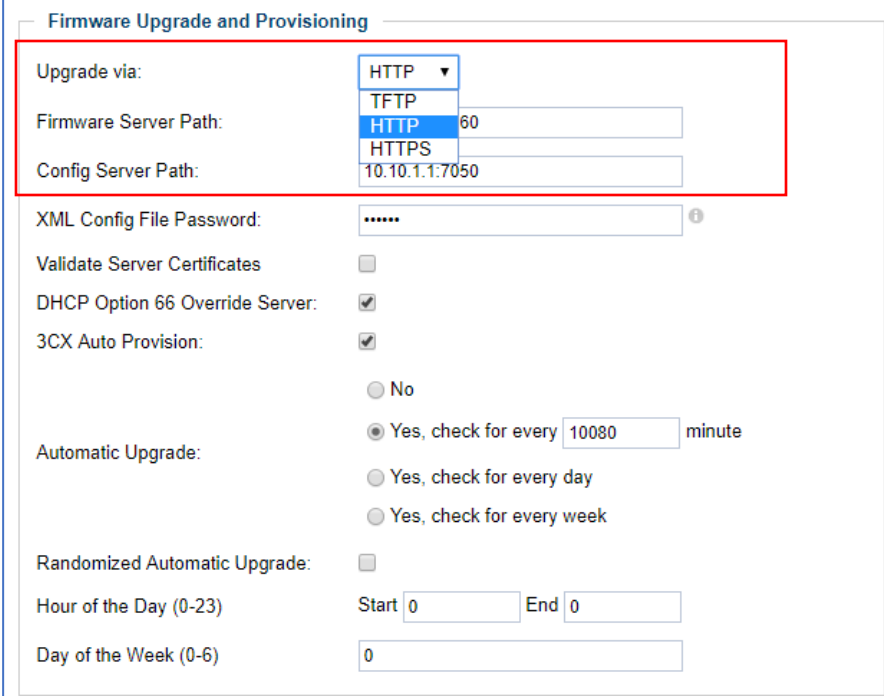

Figure 34: Firmware Upgrade and Provisioning

Notes:

- Grandstream recommends end-user use the Grandstream HTTP server:
firmware.grandstream.com
- For large companies, we recommend maintaining their own TFTP/HTTP/HTTPS server for upgrade and provisioning procedures. Instructions for local firmware upgrade using TFTP server:
 1. Unzip the file and put all of them under the root directory of the TFTP server.
 2. Load the TFTP server from the PC and make sure the device in the same LAN segment.
 3. Please go to File -> Configure -> Security to change the TFTP server's default setting from "Receive Only" to "Transmit Only" for the firmware upgrade.
 4. Start the TFTP server.
 5. In webGUI of IP camera, configure the Firmware Server Path with the IP address of the PC.
 6. Update the change and reboot the unit

End users can also choose to download the free HTTP server from <http://httpd.apache.org/> or use Microsoft IIS web server.



CONFIGURATION FILE DOWNLOAD

Grandstream SIP Device can be configured via Web Interface as well as via Configuration File through TFTP or HTTP/HTTPS. “Config Server Path” is the TFTP or HTTP/HTTPS server path for configuration file. It needs to be set to a valid URL, either in FQDN or IP address format. The “Config Server Path” can be same or different from the “Firmware Server Path”.

A configuration parameter is associated with each particular field in the web configuration page. A parameter consists of a Capital letter P and 1 to 3 (Could be extended to 4 in the future) digit numeric numbers. i.e., P2 is associated with “Admin Password” in the ADVANCED SETTINGS page. For a detailed parameter list, please refer to the corresponding firmware release configuration template.

When Grandstream Device boots up or reboots, it will issue request for configuration file named “cfgxxxxxxxxxxxx.xml”, where “xxxxxxxxxxxx” is the MAC address of the device, i.e., “cfg000b820102ab.xml”. The configuration file name should be in lower cases.

Notes:

- GXV3500 only support XML automatic provisioning.
- Grandstream recommends end-user use the Grandstream HTTP server:
- Upgrade can be triggered via TELNET by using command: upgrade.



RESTORE FACTORY DEFAULT SETTING

WARNING!

Restoring the Factory Default Setting will DELETE all configuration information of the camera. Please BACKUP or PRINT out all the settings before approach to following steps. Grandstream will not take any responsibility if you lose all the parameters of setting or cannot connect to your VoIP service provider.

Reset from Web Interface (Soft Reset)

This page allows user to configure dynamic network related parameters:

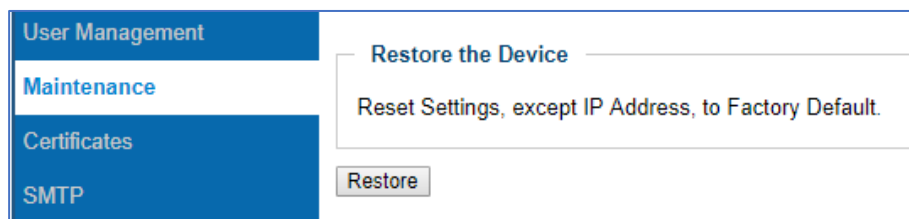

Figure 35: Factory Reset from Web Interface

Note: Reset can be triggered via TELNET by using command: restore.

Reset via Button (Hard Reset)

To “hard” factory reset the camera, with the camera powered on, press and hold the “reset” button for 15 seconds until the IP camera reboot. The internal small red power LED will illustrate “On → Off → On”, meaning a successful hard factory reset.



Figure 36: GXV3500 Front View

1. **V_IN, BNC Interface** : GXV3500 BNC interface, connect to analog camera as Video Input (Voltage: 1.0V p-p; Resistance 75 Ω)
2. **MIC_IN**: 3.5mm socket for external 3rd party microphone input.
3. **RESET**: PIN hole, press & hold for 15 seconds to factory reset the device.

GXV3500 HOME WEB PAGE (DECODE MODE)

Once click “Decode Home Page” from the Home page of the Encode mode, the device will prompt and reboot to switch itself from Encode Mode to Decode Mode.

Following Home Page of Decode Mode will be displayed once the device boots up:

Home Page (Decode Mode)



Decoder Settings

Stream Format: RTSP

Default Stream: 1

Enable Patrol:

Video Output Type: Auto or NTSC

Real Size:

Buttons: Save, Start Patrol

No.	Patrol	RTSP URL	User Name	Password	Description	Time(s)
1	<input type="checkbox"/>	rtsp://192.168.5.138	admin	•••••	GXV3611ir	60
2	<input type="checkbox"/>	https://192.168.5.116/jpeg/mjpeg.html	admin	•••••	GDS3710	60
3	<input type="checkbox"/>					60
4	<input type="checkbox"/>					60
5	<input type="checkbox"/>					60
6	<input type="checkbox"/>					60
7	<input type="checkbox"/>					60
8	<input type="checkbox"/>					60

Buttons: Save

Figure 37: Decode Home Page

Table 19: Decode Home settings

Stream Format	Format of the data stream to be decoded: RTSP: Decode RTSP data stream format. SIP Phone: Decode SIP Phone call (UDP streaming). HTTP: Decode HTTP data stream. (similar to VLC Player)
Default Stream	Select stream to be decoded, maximum 8 stream can be selected, but only one stream can be decoded at any given moment.
Enable Patrol	Click to select whether to run the decoding in Patrol Mode.

Video Output Type	Analogue Video Output Mode: Auto to NTSC; Auto to PAL; NTST; PAL.
Real Size	Select to display in Home Page the Real Size of the decoded video.

Decode Setting Explanation:

- Patrol: Select to enable and add the stream to “Patrol” mode
- RTSP URL: Input the RTSP URL or HTTP URL stream for GXV3500 to decode
- User Name: User Name or ID if required to decode the related stream
- Password: Password if required to decode the related stream
- Description: Name used to describe or identify the stream decoded
- Times: Timer (in second) used in Patrol Mode for this particular stream

Notes:

- ONLY H.264 supported. GXV3500 can NOT decode MJPEG stream
- ONLY support D1 max. Resolution. Therefore if remote side is Grandstream HD or FHD camera, it can NOT be displayed to TV output due to analogue limitation.
- The maximum decoding resolution is: 704x576, 704x480, and 640x480.
- For most Grandstream HD/FHD IP camera, this means GXV3500 will ONLY decode the second data stream, it can NOT decode resolution more than D1 or VGA, because of the limitation of analogue interface output.
- For 3rd party camera, the best way to try whether GXV3500 can decode it or not is using VLC Player to decode the 3rd party camera.
- If VLC can NOT decode and display the 3rd party stream, then GXV3500 will NOT do it either.
- VLC is Open-Source media player, you can get from: <http://www.videolan.org/vlc/index.html>
- ❖ VideoLAN, VLC, VLC media player and x264 are trademarks internationally registered by the [VideoLAN non-profit organization](http://www.videolan.org/). VideoLAN software is licensed under various open-source licenses: use and distribution are defined by each software license.



Basic Settings Explanation (Decode Mode)

System Setting Page (Decode Mode)

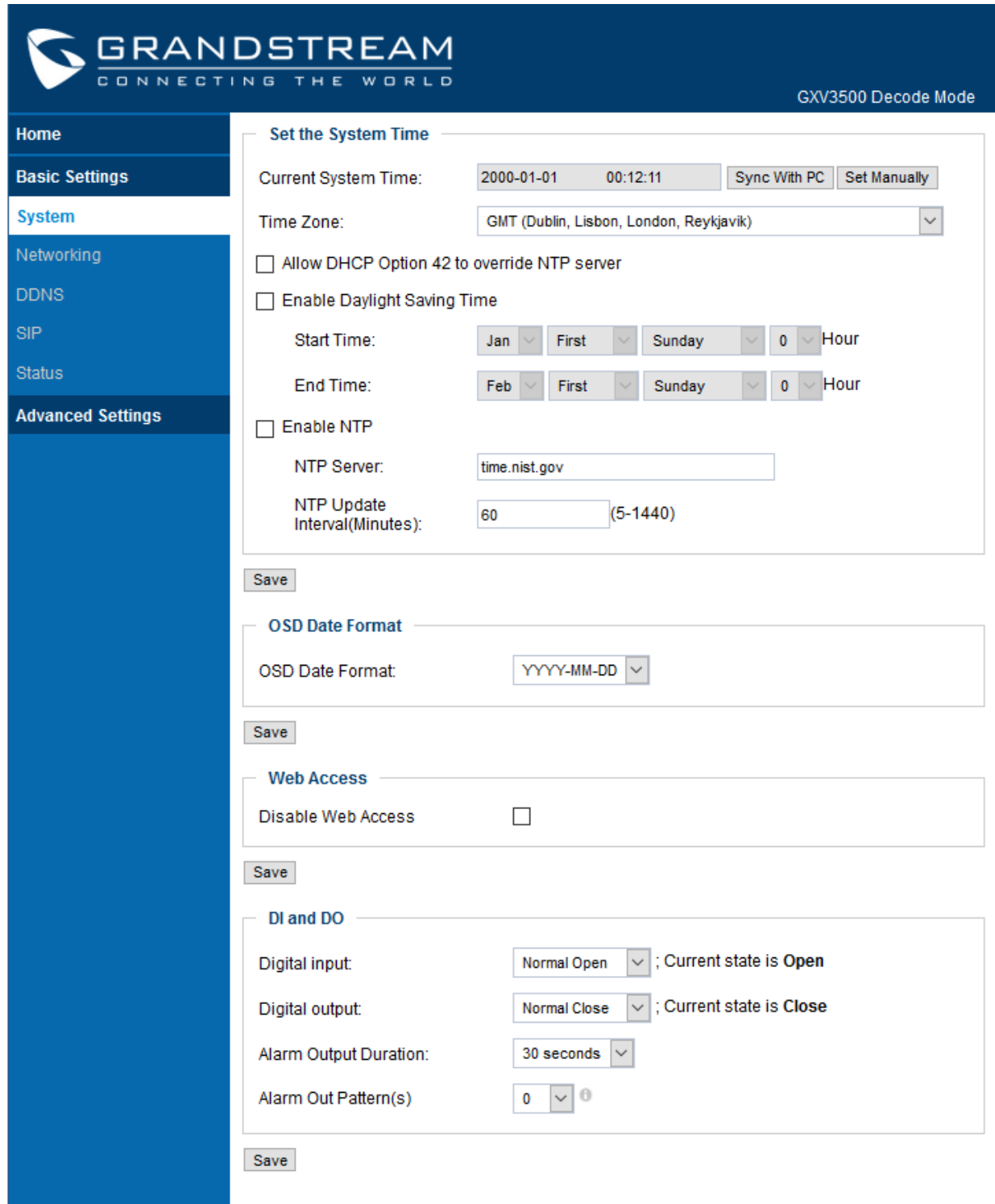

GRANDSTREAM
CONNECTING THE WORLD

GXV3500 Decode Mode

Home

Basic Settings

System

Networking

DDNS

SIP

Status

Advanced Settings

Set the System Time

Current System Time: 2000-01-01 00:12:11

Time Zone: GMT (Dublin, Lisbon, London, Reykjavik) ▾

Allow DHCP Option 42 to override NTP server

Enable Daylight Saving Time

Start Time: Jan ▾ First ▾ Sunday ▾ 0 ▾ Hour

End Time: Feb ▾ First ▾ Sunday ▾ 0 ▾ Hour

Enable NTP

NTP Server: time.nist.gov

NTP Update Interval(Minutes): 60 (5-1440)

OSD Date Format

OSD Date Format: YYYY-MM-DD ▾

Web Access

Disable Web Access

DI and DO

Digital input: Normal Open ▾ ; Current state is **Open**

Digital output: Normal Close ▾ ; Current state is **Close**

Alarm Output Duration: 30 seconds ▾

Alarm Out Pattern(s): 0 ▾ ⓘ

Figure 38: System Page (Decode)

Table 20: System settings

Current System Time	Display time current system is running at.
Sync with PC	Click to synchronize current time with computer.
Set Manually	Click to manually set the current time and date.
Time Zone	Select from pull down menu the time zone unit located.
Allow DHCP Option 42 to override NTP server	Defines whether DHCP Option 42 should override NTP server or not. When enabled, DHCP Option 42 will override the NTP server if it is set up on the LAN. The default setting is "Yes".
Enable Day Light Saving Time	Enable and Configure Day Light Saving Start Time and End Time.
Enable NTP	Enable and configure NTP server and update interval.
(On Screen Display) OSD Date Format	OSD Date format, choose based on user preference.
Device Name Setting	Set the name of the camera which will be shown in the result of "Search Tool" of GSurf_Pro VMS program.
Disable Web Access	Choose to Enable/Disable HTTP Web Access
DI and DO	DI and DO initial status for Alarm In or Out operation.
Digital Input	State of Digital Input, normal at Open state.
Digital Output	State of Digital Output, normal at Open state
DO Output Duration	Select operation of Alarm Output Duration from pull down list.
Alarm Out Pattern (s)	Configure an ON/OFF cadence during that specific duration of time which the alarm out follow when played. Range is from 0-3. Default is 0. When set to 0, no cadence will be applied and alarm out will be played continuously.

Audio Setting Page (Decode Mode)

This page allows user to configure to adjust the Speaker's volume:

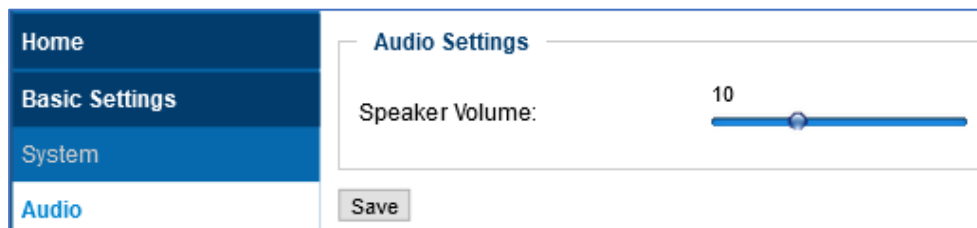
Figure 39: Audio Setting Page (Decode)

Networking Setting Page (Decode Mode)

This page allows user to configure network related parameters:

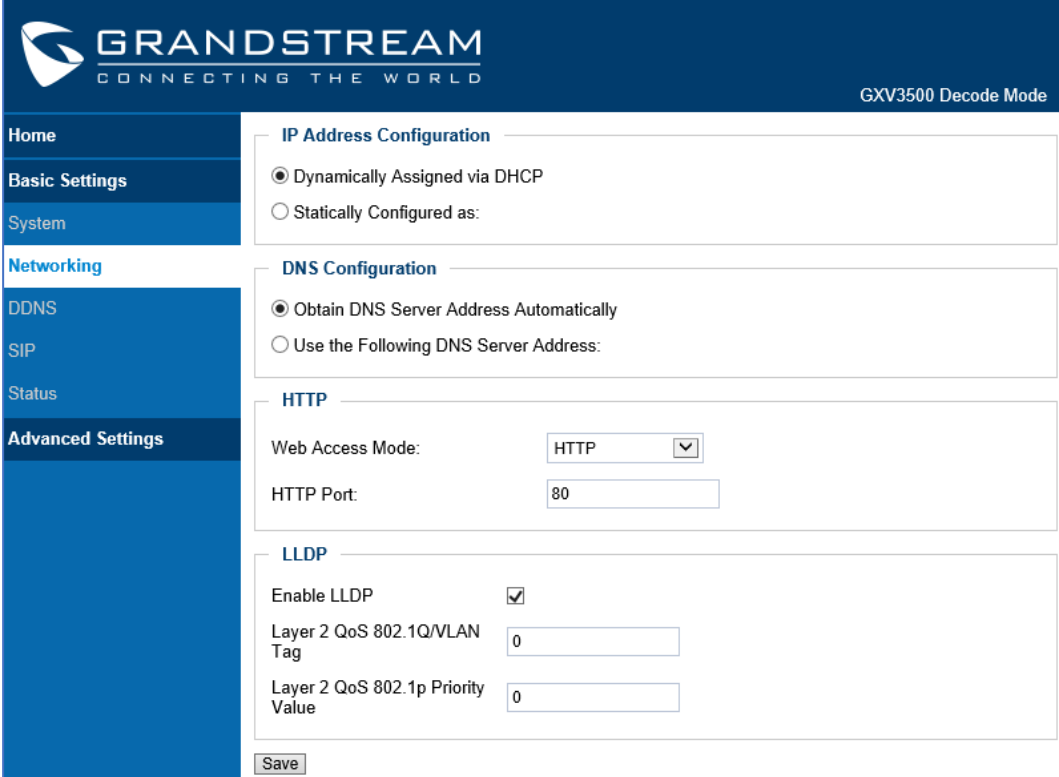

Figure 40: Networking Page (Decode)

Table 21: Networking settings

Dynamically Assigned via DHCP	Default setting, DHCP server assign IP to camera.
Statically Configured as	Static IP address configuration (Preferred for Port FWD).
DNS Configuration	DNS server IP. Must be configured if using static IP.
Web Access Mode	Selects the access mode to the web GUI either HTTP or HTTPS.
HTTP Port	Specifies the TCP port for Web Access, Default is 80.
Enable LLDP	Controls the LLDP (Link Layer Discovery Protocol) service. The default setting is "Enabled".
Layer 2 QoS 802.1Q/VLAN Tag	Assigns the VLAN Tag of the Layer 2 QoS packets. Default value is 0. Range is from 0 - 4094.
Layer 2 QoS 802.1p Priority Value	Assigns the priority value of the Layer2 QoS packets. Default value is 0. Range is from 0 - 7.

Notes:

- If camera behind SOHO router with port forwarding configuration for remote access, static IP or static DHCP has to be used to avoid IP address change after router reboot.
- TCP port above 5000 suggested if Port Forward HTTP for remote access, due to some ISP would block port 80 for inbound traffic. For example, change the default HTTP port from 80 to 8088, to make sure the TCP port not likely blocked.
- In addition to HTTP port, RTSP port is also required to configure via port forward, so that remote party can view the video stream.
- If revise the default TCP port 80 to port “A”, then RTSP port should be “2000+A” (changed from default TCP 554). Both TCP port “A” and “2000+A” should be configured for port forwarding in the router. For example, the HTTP port changed to 8088, the RTSP port now should be 10088, both TCP ports 8088 and 10088 should be configured for port forwarding in order for remote camera access: 8088 for web portal, 10088 for video streaming.

DDNS Setting Page (Decode Mode)

This page allows user to configure dynamic DNS related parameters:

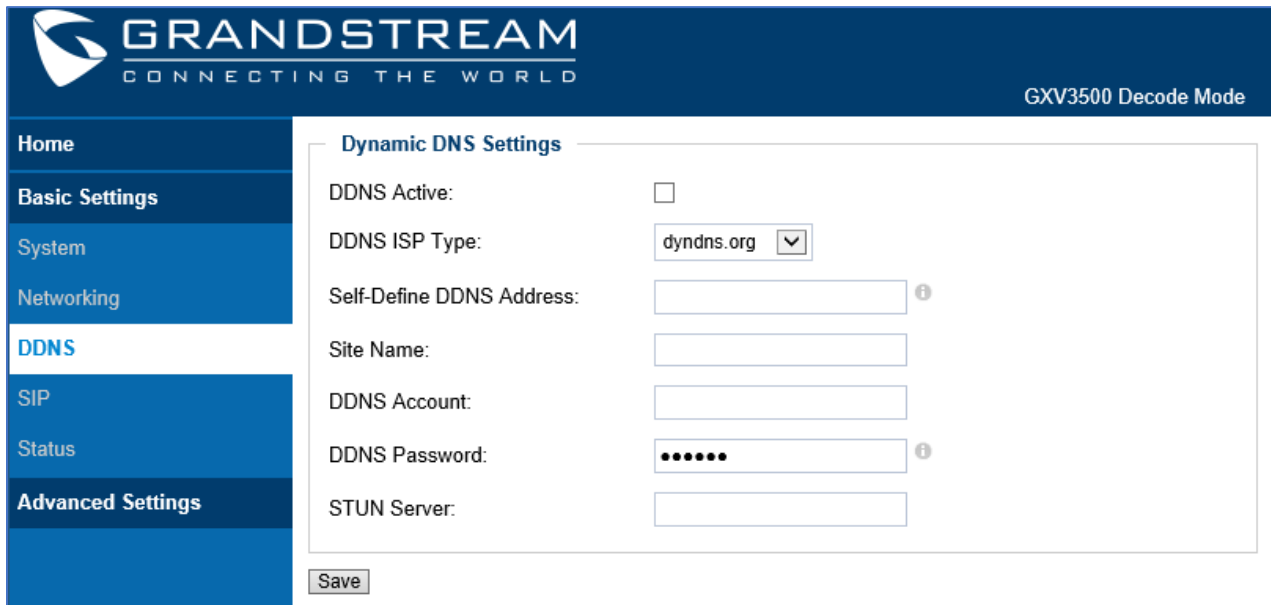

Figure 41: DDNS Setting Page (Decode)

Table 22: DDNS Setting

DDNS Active	Enable DDNS by check this field.
DDNS ISP Type	Select the DDSN service provider from the pull-down menu list.
Self-Define DDNS Address	Input the self-defined DDNS address.
Site Name	DDNS site name.
DDNS Account	DDNS account name



DDNS Password	DDNS password
STUN Server	Stun server FQDN or IP. If device behind a non-symmetric router, STUN server can help to penetrate & resolve NAT issue.

SIP Setting Page (Decode Mode)

GXV3500 Decode can be configured as SIP endpoint to decode the video SIP call, showing remote SIP video phone or IP camera during SIP video call, and displaying to audio and video to the connected big screen TV set.



Basic Settings	Registered: Offline
System	Unregister On Reboot: <input type="checkbox"/>
Audio	SIP Settings
Networking	Account Name: <input type="text" value="1008"/> ⓘ
DDNS	SIP Server: <input type="text" value="192.168.5.110"/> ⓘ
SIP	Outbound Proxy: <input type="text"/> ⓘ
Status	SIP User ID: <input type="text"/> ⓘ
Advanced Settings	Authenticate ID: <input type="text"/> ⓘ
	Authenticate Password: <input type="password" value="*****"/> ⓘ
	STUN Server: <input type="text"/> ⓘ
	Stream: <input type="text" value="Secondary"/> ▼
	Preferred Vocoder 1: <input type="text" value="PCMU"/> ▼
	Preferred Vocoder 2: <input type="text" value="PCMA"/> ▼
	Voice Frames Per TX: <input type="text" value="2"/> ⓘ
	Register Expiration(Second): <input type="text" value="3600"/> ⓘ
	Re-register before Expiration(s): <input type="text" value="0"/> ⓘ
	Special Feature: <input type="text" value="Standard"/> ▼
	NAT Traversal: <input type="text" value="No"/> ▼
	Local SIP Port: <input type="text" value="5060"/> ⓘ
	Local RTP Port: <input type="text" value="5004"/> ⓘ
	Use Random Port: <input type="checkbox"/>
	Auto On-Hook Timer: <input type="text" value="300"/> ⓘ
	Enable Keep Alive: <input type="checkbox"/>
	Accept Direct IP Call: <input checked="" type="checkbox"/>
	Enable White List Number Filter: <input type="checkbox"/> ⓘ
	DNS Cache Expiration Time(m): <input type="text" value="0"/> ⓘ
	DNS Cache Duration(m): <input type="text" value="0"/> ⓘ
	DNS Mode: <input type="text" value="A Record"/> ▼
	Activate Alarm Out Upon Incoming Call: <input type="checkbox"/>

Figure 42: SIP Setting Page (Decode)

Table 23: SIP Setting Page (Decode)

Registered	SIP registration status. Display “Online” in Green, “Offline” in Red.
Unregistered on Reboot	If checked and SIP server support, reboot camera will unbind all registered end points using this SIP account.



Account Name	SIP account name used for self-identification.
SIP Server	FQDN or IP of SIP server from VoIP service provider.
Outbound Proxy	IP or FQDN of Outbound proxy server, helps penetrate NAT/Firewall.
SIP User ID	SIP username, or telephone number from ITSP.
Authenticate ID	Authenticate ID used by SIP proxy.
Authenticate Password	Authenticate password used by SIP proxy.
STUN Server	STUN server used to resolve NAT if have.
Stream	Which stream used for SIP call. Default 2nd stream and only 2nd .
Preferred Vocoder 1/2	Audio codec used for SIP call. It supports G.711A and G.711U.
Voice Frame Per TX	<p>Configures the number of voice frames transmitted per packet. When configuring this, it should be noted that the “ptime” value for the SDP will change with different configurations here. This value is related to the codec used and the actual frames transmitted during the in-payload call. For end users, it is recommended to use the default setting, as incorrect settings may influence the audio quality.</p> <p>The default setting is 2.</p>
Registration Expiration	Registration expiration time, default 3600 seconds.
Re-register before Expiration	<p>Specifies the time frequency (in seconds) that the GXV3500 sends reregistration request before the Register Expiration. The default value is 0.</p> <p>Range is from 0-64800 seconds.</p>
Special Feature	Users may need select special features to meet some switch requirements. Users can choose from Standard, Broadsoft and Telefonica. Default is Standard.
NAT Traversal	<p>This parameter configures whether the NAT traversal mechanism is activated. Users could select the mechanism from No (Default), STUN, Keep-alive, UPnP, Auto. If set to “STUN” and STUN server is configured, the phone will route according to the STUN server. If NAT type is Full Cone, Restricted Cone or Port-Restricted Cone, the phone will try to use public IP addresses and port number in all the SIP&SDP messages.</p> <p>The phone will send empty SDP packet to the SIP server periodically to keep the NAT port open if it is configured to be “Keep-alive”.</p> <p>Configure this to be “No” if an outbound proxy is used. “</p>
Local SIP Port	Local SIP port, default 5060.
Local RTP Port	Local RTP port for media, default 5004.



Use Random Port	<p>Forces the GXV3500 to use random ports for both SIP and RTP messages. This is usually necessary when multiple units are behind the same full cone NAT. The default setting is “Disabled”.</p> <p>Note: This parameter must be set to “Disabled” for Direct IP Calling to Work.</p>
Local SIP Port	Configure the Local SIP Port used by the GXV3500. Default is 5060.
Local RTP Port	Configure the Local RTP Port used by the GXV3500. Default is 5004.
Use Random Port	<p>Forces the GXV3500 to use random ports for both SIP and RTP messages. This is usually necessary when multiple units are behind the same full cone NAT. The default setting is “Disabled”.</p> <p>Note: This parameter must be set to “Disabled” for Direct IP Calling to Work.</p>
Auto On-Hook Timer	Timer (in seconds) for automatic disconnecting SIP call. Default 300.
Enable Keep Alive	Checked to help NAT resolution, sending alive packets.
Accept Direct IP Call	Check to accept peer-to-peer IP call in LAN without SIP server.
Enable White List Number Filter	White List (Allowed Caller) Phone numbers allowed calling into the camera.
DNS Cache Expiration Time(m)	The GXV3500 will attempt to renew its DNS cache once this expiration time is reached.
DNS Cache Duration(m)	This the duration of time that the GXV3500 keeps the save DNS cache in case of the DNS server not responding to the new DNS Lookup requests.
DNS Mode	<p>Selects DNS mode to use for the client to look up server.</p> <ul style="list-style-type: none"> • A Record: resolves IP Address of target according to domain name. • SRV: DNS SRV resource records indicate how to find services for various protocols. • NAPTR/SRV: Naming Authority Pointer according to RFC2915. <p>Default is A Record.</p>
Activate Alarm Out Upon Incoming Call	The Alarm output will triggered if an incoming call is received.
White List (Allowed Caller)	Phone numbers allowed calling into the camera.

Status Page (Decode Mode)

This page shows the GXV3500 Decode Mode operation status:



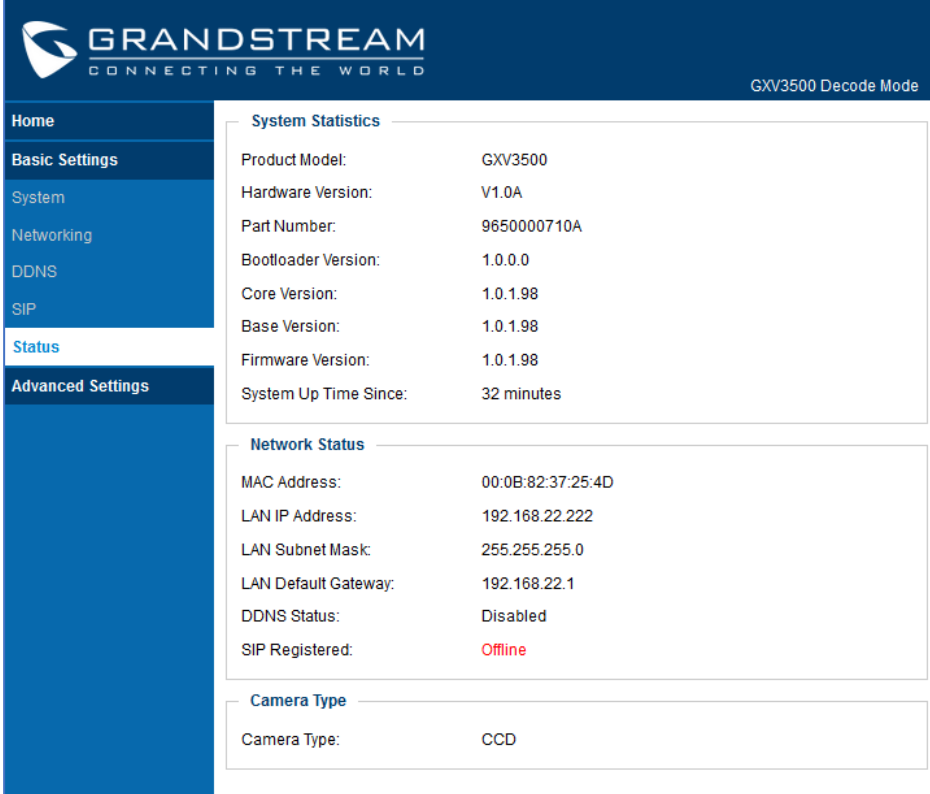

GRANDSTREAM
CONNECTING THE WORLD

GXV3500 Decode Mode

Home	System Statistics
Basic Settings	Product Model: GXV3500
System	Hardware Version: V1.0A
Networking	Part Number: 9650000710A
DDNS	Bootloader Version: 1.0.0.0
SIP	Core Version: 1.0.1.98
Status	Base Version: 1.0.1.98
Advanced Settings	Firmware Version: 1.0.1.98
	System Up Time Since: 32 minutes
	Network Status
	MAC Address: 00:0B:82:37:25:4D
	LAN IP Address: 192.168.22.222
	LAN Subnet Mask: 255.255.255.0
	LAN Default Gateway: 192.168.22.1
	DDNS Status: Disabled
	SIP Registered: Offline
	Camera Type
	Camera Type: CCD

Figure 43: Status Page (Decode)

Notes:

- When SIP account registered, the status will display “Online” in Green.
- When SIP account unregistered, the status will display “Offline” in Red, as below.

SIP Registered: **Offline**

Advanced Settings Explanation (Decode Mode)

User Management Page (Decode Mode)

This page allows customer to configure the user and related privilege

Home	Manage User	
Basic Settings	Existing User Name:	--Add New User-- <input type="button" value="v"/>
Advanced Settings	User Name:	<input type="text"/>
User Management	User Password:	<input type="text"/> ⓘ <input type="button" value="Add"/>
Maintenance	Confirm User Password:	<input type="text"/> <input type="button" value="Update"/>
Certificates	Privilege:	Administrator <input type="button" value="v"/> <input type="button" value="Delete"/>
PTZ	Manage Anonymous Viewing	
Syslog	Allow Anonymous Viewing:	<input checked="" type="checkbox"/>
<input type="button" value="Save"/>		

Figure 44: User Management Page (Decode)

Table 24: User Management (Decode)

Existing User Name	Allow revise existing user or add new user.
User Name	The name of users need to be revised.
User Password	New password if revise password.
Confirm User Password	Re-enter the new password for verification, must match.
Privilege	Choose user privilege. Two levers: Administrator, Viewer. Viewer cannot change any settings.
Allow Anonymous Viewing	When checked, no security enhanced. Any person can view the camera if knowing the IP or FQDN of the camera, but cannot change anything, just view ONLY.

Maintenance Page (Decode Mode)

This page allows user to maintain the GXV3500 in Decode Mode:

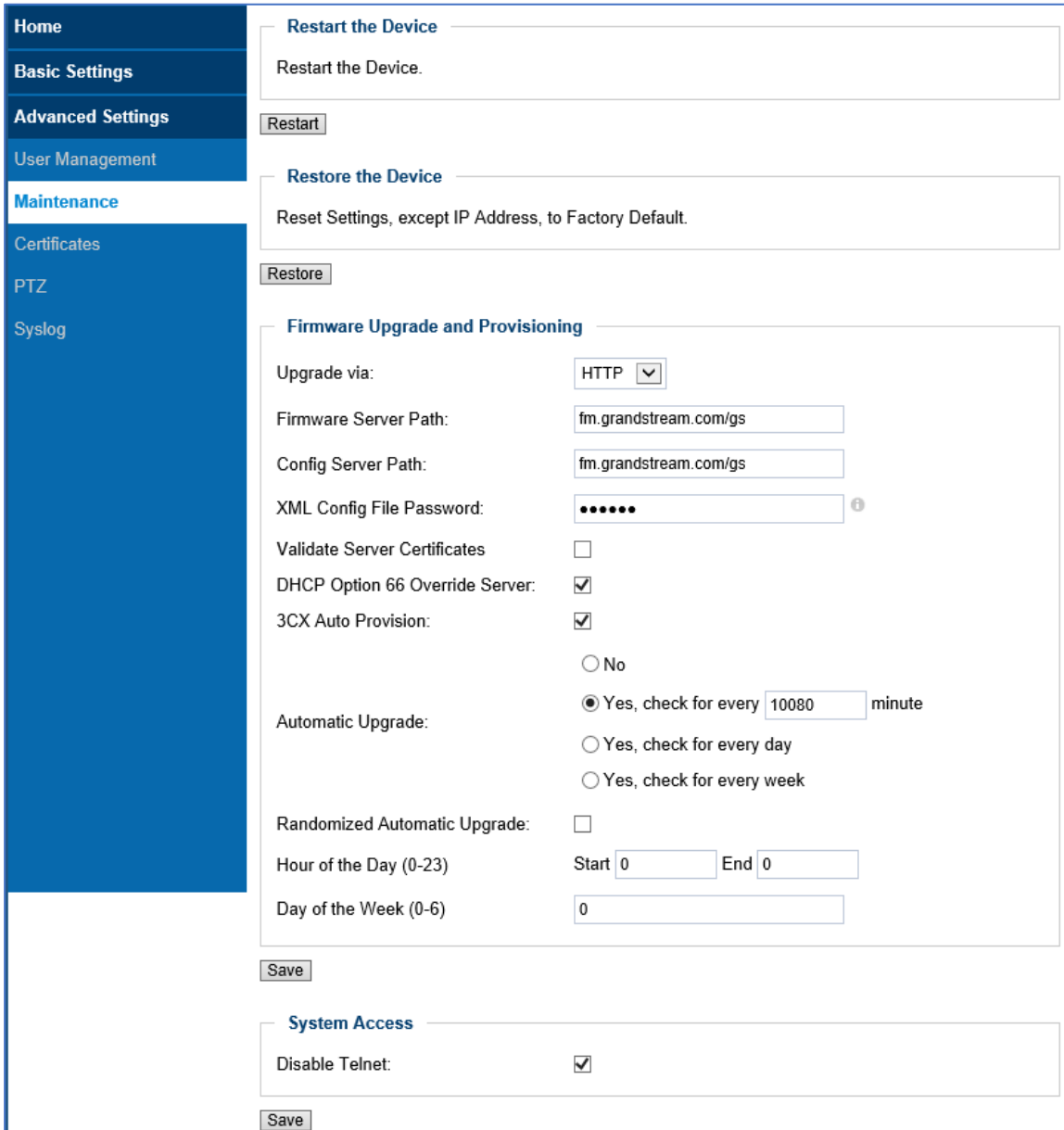

Figure 45: Maintenance Page (Decode)

Table 25: User Management page

Restart	When clicked, the GXV3500 will reboot or restart (soft reboot).
Restore	When clicked, the camera will be reset to factory default, wiping out all the configurations (except IP address).
Upgrade via	Firmware upgrade via TFTP, HTTP or HTTPS.
Firmware Server	Sets IP address or domain name of firmware server. The URL of the server that hosts



Path	the firmware release. Default is "fm.grandstream.com/gs". Note: Make sure to not prepend address with "http://" or any other protocol
Config Server Path	Sets IP address or domain name of configuration server. The server hosts a copy of the configuration file to be installed on the GXV3500. Default is "fm.grandstream.com/gs". Note: Make sure to not prepend address with "http://" or any other protocol.
XML Config File Password	Password for encrypt the XML based configuration file.
Validate Server Certificates	Enable this option in order to validate certificate with trusted ones during TLS connection.
DHCP Option 66 Override Server	If DHCP option 66 is checked, the GXV3500 will attempt to download firmware file and XML config file from the server URL provided by DHCP overriding configured Firmware Server Path and Provisioning Server Path (even if left blank).
3CX Auto Provision	Enable or disable the 3CX PnP Auto Provision. When enabled, the GXV3500 to broadcast the SIP SUBSCRIBE message during booting up to allow itself to be discovered and be configured by the SIP platform. The default setting is "Yes".
Automatic Upgrade	Checked to enable automatic firmware upgrade and provisioning.
Randomized Automatic Upgrade	Randomized Automatic Upgrade within the range of hours of the day or postpone the upgrade every X minute(s) by random 1 to X minute(s).
Disable Telnet	Check to disable Telnet to enhance security.

Note:

- Only XML based automatic provisioning is supported by GXV3500.

Certificates Page

This page allows users to upload up to 6 Trusted CA certificate files which will be trusted by the GXV3500 during SSL exchange.

Also users are allowed to configure the device with custom certificate signed by custom CA certificate under the Custom Certificate section.



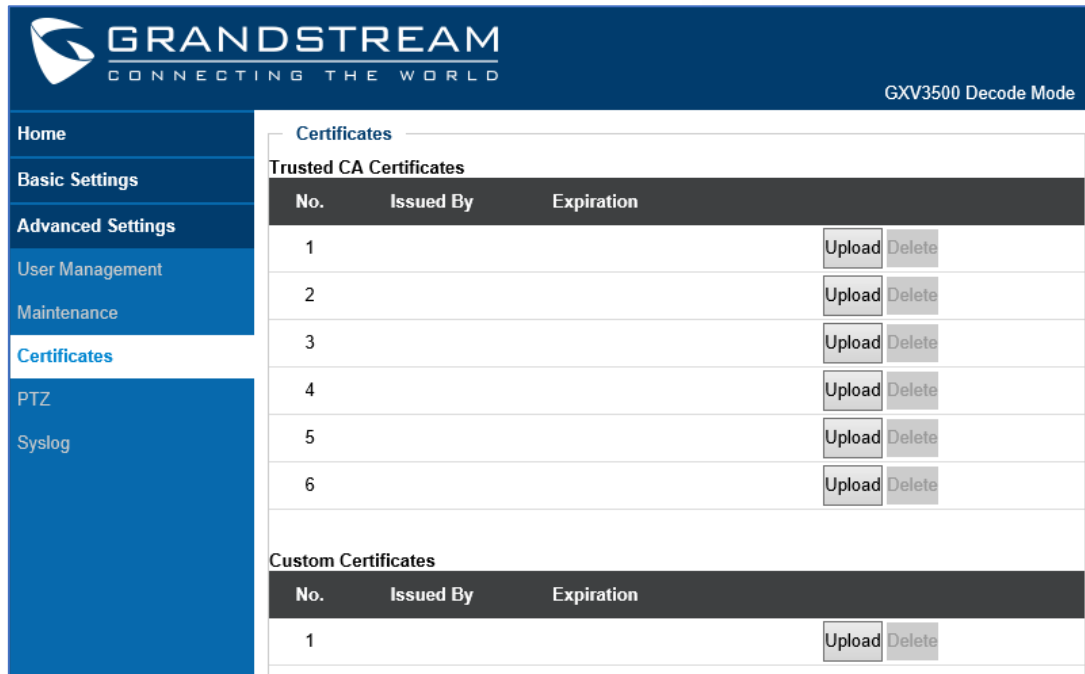

Figure 46: Certificates page

In order to upload your Trusted CA certificate:

Click on **Upload** button to upload a file and some related information to the uploaded file will be displayed, such as **“Issued by”** and **“Expiration”**.

Trusted CA Certificates			
No.	Issued By	Expiration	
1	-	2021-12-11 11:33:00	Upload Delete

User could press **Delete** to delete one of the files.

In order to upload your Custom certificate:

Click on **Upload** button to upload a file and some related information to the uploaded file will be displayed, such as **“Issued by”** and **“Expiration”**.

Custom Certificates			
No.	Issued By	Expiration	
1			Upload Delete

User could press **Delete** to delete one of the files.

PTZ (Decode Mode)

This page allows user to configure GXV3500 (decode mode) to use its related RS-485 port as output control of 3rd party PTZ compatible device or TEXT output device via RS-485 port.

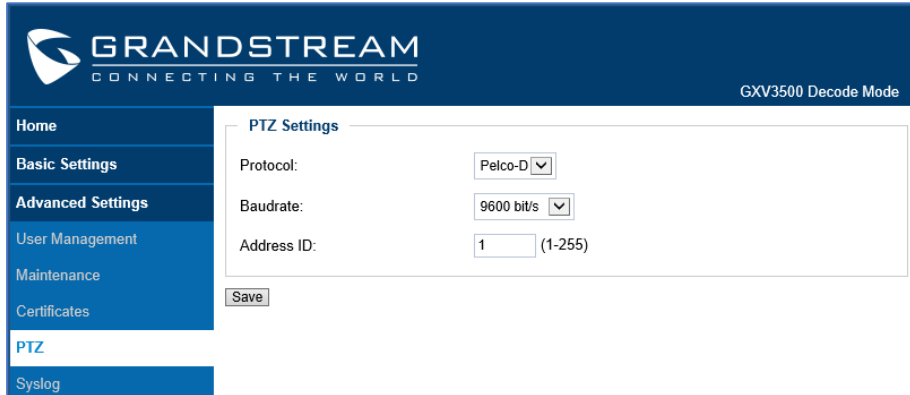

Figure 47: PTZ Configuration Page (Decode)

Table 26: Configuration Page (Decode)

Protocol	Pull-down to select supported PTZ protocol by connected analogue camera. Only Pelco-D or Pelco-P allowed.
Baudrate	The baudrate used by the analogue camera interface, select from the pull-down menu.
Address ID	Hardware Pelco-D or Pelco-P address ID used by the analogue camera, please refer to related camera user manual for this ID (or PIN switch in the UM), then fill in related matching address into this field.

Notes:

- The address ID has to be same and match the one used in the connected analogue camera. Otherwise the PTZ will not function or behave abnormal due to the wrong Pelco-D or Pelco-P address used.
- Detailed information of passing TEXT or CMD via RS-485 port, please refer to related 3rd party device connected, or refer to HTTP API for more information:

http://www.grandstream.com/sites/default/files/Resources/grandstream_http_api_1.0.0.54.pdf

Remote Alarm_Out Peering with GXV3500 (Decode Mode) :

The IP66 weather-proof IP cameras GXV3672, GXV3674 and GXV3610 series do not have built-in Alarm_Out interface, but when peering with Grandstream GXV3500 encoder/Decoder, the GXV3500's built-in Alarm_Out interface (**running at Decode mode**) can behave as remote Alarm_Out for those IP Cameras. The benefit of such peering is the Alarm_Out circuit is not physically wired into the IP Camera anymore, with the Ethernet network behaving as wiring, the Alarm_Out circuit can now be located to convenient places where GXV3500 located.

This means IP Camera can be in location A, while the Alarm_Out can be in location B (A and B can be in



the same or different places as long as A and B can reach each other via network/internet). This will help a lot of users to monitor site remotely and take appropriate action, because there are situations where location A with cameras, but actions have to be taken from location B. With Grandstream's solution, traditional A and B limitation by the cable length is now disappear.

The configuration of such remote Alarm_Out is very simple:

GXV3672/GXV3674/GXV3610 Side:

Same configuration as previous Motion Detection configuration, just make sure "Upload to Alarm Center" checked and selected:

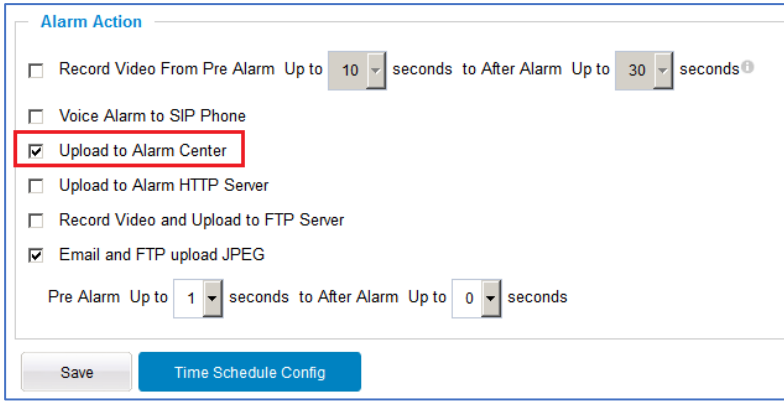

The screenshot shows the 'Alarm Action' configuration window. It contains several checkboxes and dropdown menus. The 'Upload to Alarm Center' checkbox is checked and highlighted with a red border. Other options include 'Record Video From Pre Alarm' (set to 10 seconds), 'Voice Alarm to SIP Phone', 'Upload to Alarm HTTP Server', 'Record Video and Upload to FTP Server', and 'Email and FTP upload JPEG' (checked). At the bottom, there are 'Pre Alarm' (set to 1 second) and 'After Alarm' (set to 0 seconds) settings. Buttons for 'Save' and 'Time Schedule Config' are at the bottom.

Figure 48: Remote Alarm_Out IP Camera Configuration

GXV3500 (Decode Mode) Side:

GXV3500 has to be running as **Decode Mode** when functioning as remote Alarm_Out of the peering IP Camera. The configuration is as below:

- 1) Input the **2nd stream** (*H.264 Only, MJPEG NOT supported*) as the RTSP URL, with correct credentials, as shown below.
- 2) Only ONE stream (currently decoding stream) the Motion Detection can use the GXV3500 built-in Alarm_Out interface if there are multiple RTSP URL configured in the GXV3500.

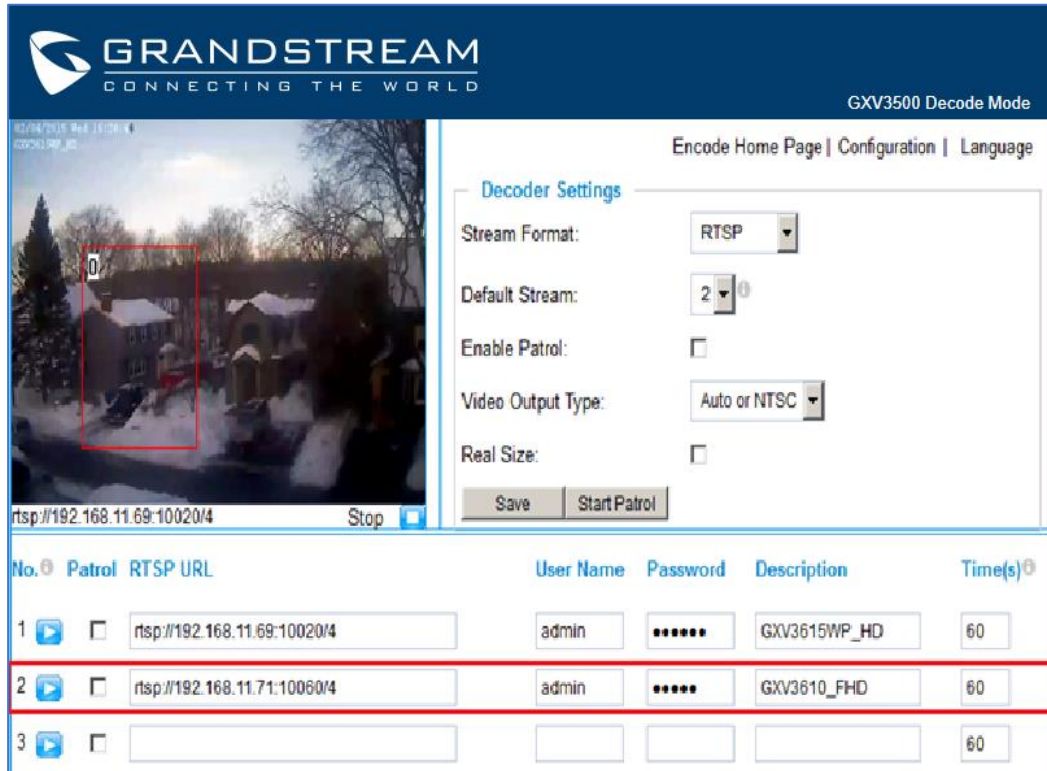
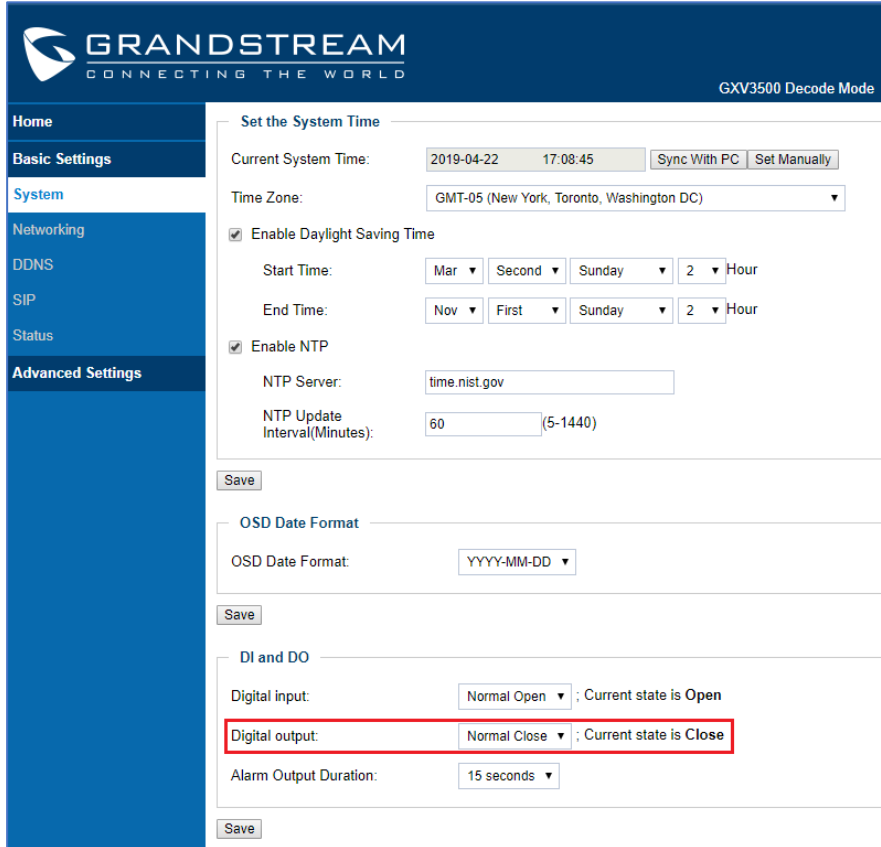

Figure 49: Remote Alarm_Out peering GXV3500 Configuration

Notes:

- GXV3500 is designed to work with **analogue camera**, with **maximum decode resolution 704x576**, this is why 2nd stream decoding used as peering for remote Alarm_Out. The RSTP setting will be:
rtsp://IPCamera:Port/4 (4 is 2nd stream of GXV3672/GXV3674/GXV3610)
- 2nd stream also consume less bandwidth therefore good for internet transmission.
- H.264 video codec has to be selected because Motion Detection not supported via MJPEG.
- All Grandstream IP Cameras without built-in Alarm_Out interface can peer with GXV3500 (Decode Mode) built-in Alarm_Out interface for Motion Detection Remote Alarm_Out. Alarm_Out duration can be configured at “System” setting page of GXV3500 Decode. See below the figure. When Alarm_Out taking action, the webpage will show the related action.

For example, below the “Digital Output Duration” is selected as “15 seconds” so the Alarm_Out will act for 15 seconds before reverting back to previous state. In below case, the default is circuit “Open”, when Motion Detection alarm triggered, the circuit state changed to “Close”, as illustrated below for 15 seconds and then switch back to previous “Open” state.



GRANDSTREAM
CONNECTING THE WORLD

GXV3500 Decode Mode

Home

Basic Settings

System

Networking

DDNS

SIP

Status

Advanced Settings

Set the System Time

Current System Time: 2019-04-22 17:08:45

Time Zone: GMT-05 (New York, Toronto, Washington DC) ▼

Enable Daylight Saving Time

Start Time: Mar ▼ Second ▼ Sunday ▼ 2 ▼ Hour

End Time: Nov ▼ First ▼ Sunday ▼ 2 ▼ Hour

Enable NTP

NTP Server: time.nist.gov

NTP Update Interval(Minutes): 60 (5-1440)

OSD Date Format

OSD Date Format: YYYY-MM-DD ▼

DI and DO

Digital input: Normal Open ▼ ; Current state is Open

Digital output: Normal Close ▼ ; Current state is Close

Alarm Output Duration: 15 seconds ▼

Figure 50: Remote Alarm_Out peering GXV3500 Action Output Display

Unlike the Alarm_Out interface of Grandstream IP Camera (e.g.: GXV3611IR_HD or GXV3662_HF/FHD where the related Alarm_Out interfaces are using relay switch), the GXV3500 Alarm_Out is using photocoupler circuit.

If connecting to a multimeter, you will see the Ohm changed from unlimited to several hundred Ohms depending on GXV3500 HW version.

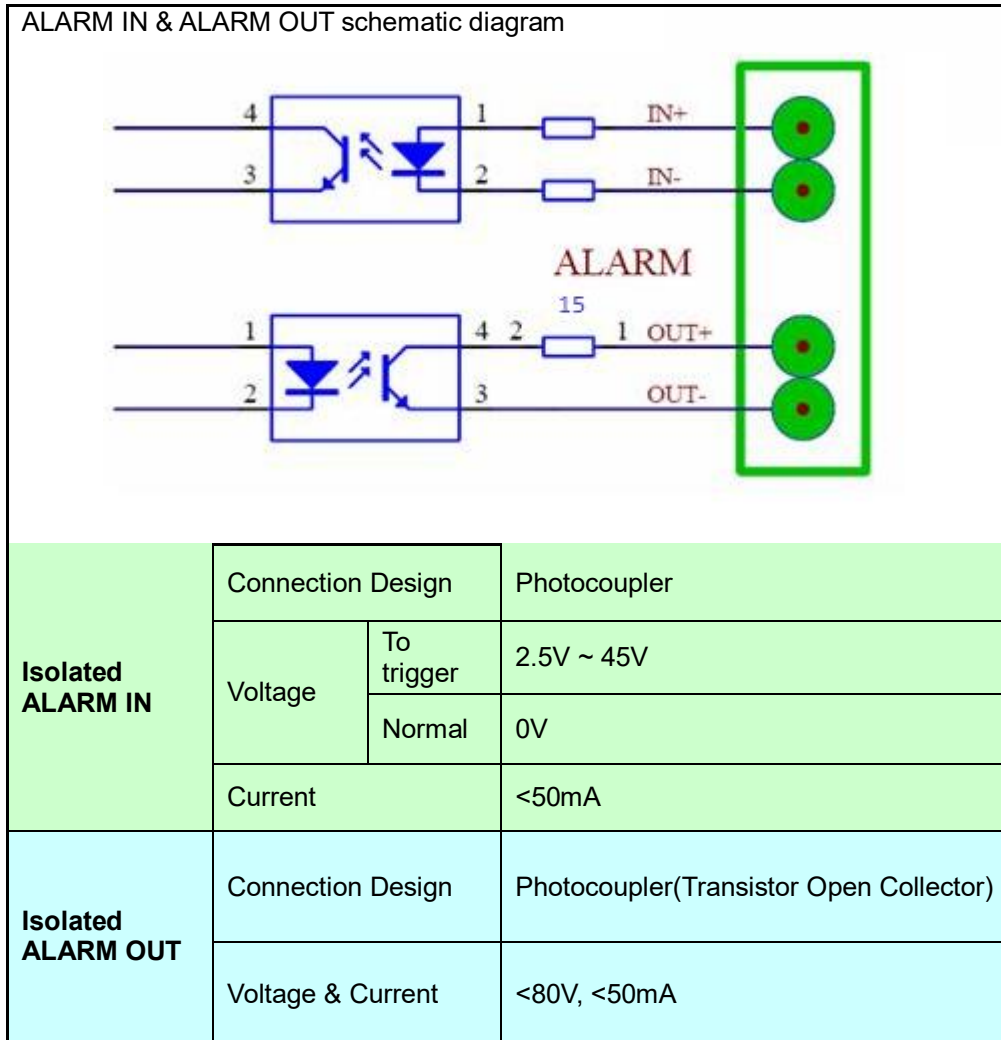

Figure 51: Peering GXV3500 Decode Alarm_Out Circuit

The above method can be used for installers to check the functionality of this feature at lab or on field before the installation. With the help of GXV3500 Decode, customers can now free from the wiring limitation and have the Alarm_Out feature for Grandstream IP66 weather-proof IP cameras.

Syslog Settings (Decode Mode)

This page allows user to enable the Syslog to help troubleshooting problems.

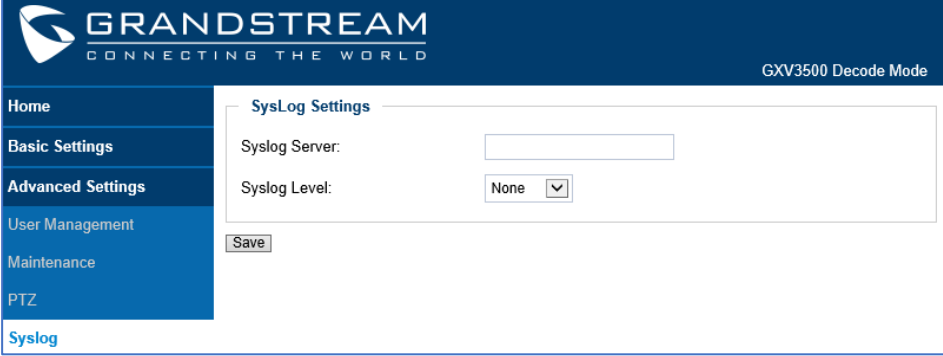

Figure 52: Syslog Page (Decode)

Table 27: Syslog (Decode)

Syslog Server	Syslog server IP or Domain Name.
Syslog Level	Lever of syslog message sent to the syslog server: None, Debug, Info, Warning, Error.

IP SURVEILLANCE FAQ

1. What is the default IP address of the GXV3500?

The default IP configuration is DHCP or 192.168.1.168 after booting up 5 minutes.

2. Why can I not view the live video stream in Microsoft Internet Explorer?

Please double check whether the Grandstream Plug-in/Active-X is installed correctly.

Once you log into the GXV3500 web interface, Internet Explorer will indicate that this website wants to install the following add-on: "GSViewer.cab" from Grandstream Networks, Inc. Please install this add-on when prompted by IE.

3. How do you manually uninstall the Grandstream video viewer add-on for IE?

Please follow these steps to uninstall the add-on:

1. Delete the *GSViewerX Control* from *C:\WINDOWS\Downloaded Program Files* directory
2. Delete *GSNetClient.dll*, *GS_Replay.exe*, *GSViewerX.ocx*, *hi_h264dec_w.dll*, *lik_VoiceEngine_dll.dll* and *GSViewerX.inf* from *C:\WINDOWS\system32*

4. Why can't I access the GXV3500 web configuration interface?

Q 1: Is your internet service down?

A 1: Connect a PC to the internet to test the connection.

Q 2: Are the PC and the device in different subnets?

A 2: Check the subnet mask and default gateway of the device and PC.

Q 3: Is there a conflict with another IP address? A 3:

Try to change the IP address of the device.

Q 4: Has the HTTP port been changed?

A 4: Contact the administrator of the device for more information.

5. The GXV3500 web configuration page is not displayed correctly in IE8?

In IE8, Compatibility View might need to be enabled for the GXV3500 web configuration page to load properly. To enable compatibility view, open IE8, click Tools, *Compatibility View Setting*, and add the GXV3500 web configuration pages to the Compatibility View.



6. Why does IE indicate to install Grandstream Video Viewer add-on after a firmware upgrade?

The add-on was properly installed before the firmware upgrade process. New firmware will often upgrade the add-on as well. To watch the live video stream, you must install the newest version of the add-on.

7. How do you watch secondary video stream?

Login to the home page of the GXV3500 web GUI, click Play to watch the video stream. To watch a secondary video stream, right click on the video, and select *Secondary Stream* on the pop-up menu. Try reinstalling the Grandstream Viewer add-on for IE if you cannot see the video stream.

8. What is DDNS? Is it important for IP surveillance product to have DDNS support?

DDNS is an acronym for Dynamic Domain Name Service. It is important to choose an IP network camera that has DDNS support for dynamic IP addresses. Chances are that the network has a dynamic IP address (which changes with every log on). A DDNS service makes sure that the camera's IP address always matches up to the current server address. DDNS also allows a website to be linked to the IP camera that is constantly updated with the correct information and has a reliable feed.

9. Why is Windows Media Player unable to play the recorded video files?

The GXV3500 uses the H.264 video codec. Windows Media Player may lack the proper H.264 Decode to play the recorded video. Please download the Microsoft FFDSHOW H.264 Decode from <http://sourceforge.net/projects/ffdshow-tryout/> and install it.

10. Alarm Triggered Events do not work with GSurf_Pro?

Please double check the Alarm Action on your GXV3500. Login to the web GUI of the GXV3500, go to the Motion Detection or Alarm Events page, and make sure option Upload to Alarm Center is checked.

11. Recommended to save the video files in different directories when using GSurf_Pro?

It is better to save video files in different directory to prevent accidental deletion of the recorded files you need.

12. How to use a cell phone to watch the GXV3500 video stream?

You must set the video resolution to QCIF to watch the GXV3500 video stream from a cell phone. Make sure to set the bit rate to 64kbps to ensure the best video quality.

13. What Smartphone application should I use to view the video?

There are free applications and paid version applications for this, you can find them in Google Play for Android phone and Apple Store for iPhone, like: IP Cam Viewer:



<http://hit-mob.com/>



14. Why the IP address of the device NOT reset when clicking the “Restore” button?

The GXV3500 could be installed in areas that are not easy to access. For example, it could be installed on the roof of a building or the ceiling of an office. This makes it difficult to reinstall the device, therefore the “Restore” function will not clear the IP address.

15. Why can't the live video stream be viewed using a mobile phone or GSurf_Pro after changing the HTTP Port of the device?

Make sure that the RTSP port of the device is set to 2000 plus the HTTP Port number. For example, if the HTTP port is 88, then the RTSP port of the device that you configured on GSurf_Pro or mobile phone should be 2088.

16. Port forwarding

Two ports must be forwarded on your router to watch video from a GXV3500 that is located on a private network from a PC in a public network. The web port (HTTP) and the RTSP port. Please make note that the RTSP port number changes according to the web port. If the web port is 80, then the RTSP port is 554. If the web port is not 80, then the RTSP port equals the web port +2000. For example, if the web port is 88, then the RTSP port will be 2088.

17. What is the “Pin Out” for the 3.5mm AV cable used in GXV3500?

The “Pin Out” layout for the supplied 3.5mm AV cable used in GXV3500 is the 1st one (highlight in **Blue**) in below table.

Basically: **1: Ground; 2: Video (Yellow); 3: Audio Right (Red); 4: Audio Left (White).**

Same as the AV cable used in Apple iBook.

3.5mm 4-Pole to RCA

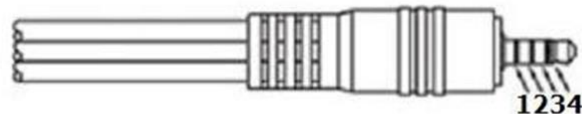

	1	2	3	4
Archos, Gigabeat, Creative Zen Vision Series, Cown iAudio, Apple iBook	Ground	Video	Right	Left
Standard Camcorder Cable, Topfield TFP20, Maxian T600	Right	Ground	Video	Left
iPod Video	Video	Ground	Left	Right
Zune	Video	Ground	Right	Left

17. Will the GXV3500 Decode/Encoder be compatible with third party cameras?

- *Encode Mode: (Analogue Camera)*
Generally, most 3rd party analogue cameras will be digitized to IP Camera when connecting to GXV3500 BNC port at Encode Mode.
- *Decode Mode: (IP Camera)*
Whether GXV3500 can decode the data stream from a 3rd party IP camera is dependent on how the stream was encoded. GXV3500 utilizes the RTSP stream and is capable ONLY H.264 formats decoding (so MJPEG is out of luck). General rule of thumb is if the RTSP stream of 3rd party IP Camera can be viewed by [VLC Media Player](#) (free open source media player software), the GXV3500 will very likely be able to decode the stream, but no guarantee due to the variety of H.264 encoding implementation by different IP Camera vendors.



EXPERIENCING THE GXV3500

Please visit our website: <http://www.grandstream.com> to receive the most up- to-date updates on firmware releases, additional features, FAQs, documentation, and news on new products.

We encourage you to browse our [product related documentation](#), [FAQs](#) and [User and Developer Forum](#) for answers to your general questions. If you have purchased our products through a Grandstream Certified Partner or Reseller, please contact them directly for immediate support.

Our technical support staff is trained and ready to answer all of your questions. Contact a technical support member or [submit a trouble ticket online](#) to receive in-depth support.

Thank you again for purchasing Grandstream SIP Speaker, it will be sure to bring convenience and color to both your business and personal life.

