



Grandstream Networks, Inc.

GAC2500

Administration Guide



GAC2500 - Administration Guide

WELCOME

Thank you for purchasing Grandstream GAC2500 Audio Conference Phone for Android™. This User Guide describes the basic concept and tasks necessary to use and configure your GAC2500. This document covers the topics of conference environment setups, start conference and the relevant operations like conference reservation. To learn the advanced features and configurations, please visit <http://www.grandstream.com/support/resources/?title=GAC2500> to download the latest "GAC2500 Administration Guide".

GAC2500 is a next generation enterprise-grade 6-line Android IP conference phone with a 4.3" capacitive touch screen that runs the Android Operating System and therefore offers full access to the hundreds of thousands of Android apps in the Google Play Store, including business productivity apps such as Skype™, Skype for Business™, and Google Hangouts™. The phone features Gigabit ports, 7-way conference, 3x microphones, 1 Micro USB port, integrated WiFi and Bluetooth for network flexibility. The GAC2500 delivers superior HD audio quality, rich and leading-edge telephony features, automated provisioning for easy deployment, advanced security protection for privacy, and broad interoperability with most 3rd party SIP devices and leading SIP/NGN/IMS platforms. GAC2500 is a perfect choice for enterprise users looking for a high performance, feature rich conference phone with superb audio quality at competitive price.

PRODUCT OVERVIEW

Feature Highlights

The following tables contain the major features of the GAC2500:

 <p style="text-align: center;">GAC2500</p>	<ul style="list-style-type: none">• Runs Android™ 4.4 and offers full access to all Android™ conference apps in the Google Play Store (e.g., Skype™, Skype for Business™, Google Hangouts™, etc.)• World-class high-fidelity sound quality with audio bandwidth of up to 18Khz• 4.3" capacitive touch screen LCD with support for flexible layout/content customization• 3x microphones (12 ft. pickup range), 1x speaker (15 ft. coverage range)• Auto-sensing Gigabit Ethernet port, Wi-Fi, PoE+, Bluetooth, Micro-USB with 3.5mm audio interface• Supports standalone IP mode or USB slave mode• Supports daisy chain (up to 2 units via RJ48 CAT5) mode in large conference room for better audio quality• NAT-T enables the phone being the Plug and Play device• Automated provisioning using TR-069 or AES encrypted XML configuration file, TLS/SRTP/HTTPS for advanced security and privacy protection
---------------------------------------------------------------------------------------------------------------------------------------	-------------------------------------------------------------------------------------------------------------------------------------------------------------------------------------------------------------------------------------------------------------------------------------------------------------------------------------------------------------------------------------------------------------------------------------------------------------------------------------------------------------------------------------------------------------------------------------------------------------------------------------------------------------------------------------------------------------------------------------------------------------------------------------------------------------------------------------------------------------------------------------------------------------------------------------------------------------------------------------------------------

GAC2500 Features in a Glance

GAC2500 Technical Specifications

The following table resumes all the technical specifications including the protocols / standards supported, voice codecs, telephony features, languages and upgrade/provisioning settings for the GAC2500.

Protocols/Standards	SIP RFC3261, TCP/IP/UDP, RTP/RTCP, HTTP/HTTPS, ARP, ICMP, DNS (A record, SRV, NAPTR), DHCP, PPPoE, SSH, TFTP, NTP, STUN, SIMPLE, LLDP, LDAP, TR-069, 802.1x, TLSv1.1, TLSv1.2, SRTP, IPv6, OpenVPN (pending)
Voice Codec	Support for G.711µ/a, G.722, G.726, iLBC, Opus, G.722.1 and G.722.1c (pending), in-band and out-of-band DTMF (In audio, RFC2833, SIP INFO), G.729A/B, VAD, CNG, AEC, PLC, AJB, AGC

Platform Bridging	Bridge SIP calls with any Android™ VoIP apps such as Skype™, Skype for Business (Lync), Google Hangouts™ and more
Telephony Features	Hold, transfer, forward (unconditional/no-answer/busy/conditional), call park/pickup, 7-way audio conference, auto answer, downloadable XML phone book (up to 2000 entries), LDAP, call waiting, call history (up to 2000 entries), flexible dial plan, personalized music ringtones, server redundancy & fail-over.
Sample Applications	Skype™, Google Hangouts™, Skype for Business (Lync), Web browser, Facebook™, Twitter™, YouTube, Google calendar, mobile phone data import/export via Bluetooth, etc. API/SDK available for advanced custom application development
Application Deployment	Allows Android 4.4 compliant applications to be deployed in the device with provisioning control
QoS	Layer 2 QoS (802.1Q, 802.1p) and Layer 3 (ToS, DiffServ, MPLS) QoS
Security	User and administrator level passwords, MD5 and MD5-sess based authentication, 256-bit AES encrypted configuration file, TLSv1.1, TLSv1.2, 128/256-bit SRTP/TLS, HTTPS, 802.1x media access control
Multi-Language	English, German, Italian, French, Spanish, Portuguese, Russian, Turkish, Polish, Chinese, Korean, Japanese, and more
Upgrade/ Provisioning	Firmware upgrade via TFTP / HTTP / HTTPS or local HTTP upload, mass provisioning using TR-069 or AES encrypted XML configuration file
Network Interface	1x auto-sensing Gigabit Ethernet port, integrated 2.4GHZ auto-band Wi-Fi (802.11a/b/g/n) and Bluetooth.
HD Audio	3x microphones (12 ft. pickup range), 1x speaker (220-18,000 Hz, 15 ft. coverage range up to 86dB)
Auxiliary Ports	3.5mm audio interface, Micro-USB interface, RJ48 interface, reset pin
Graphic Display	4.3" (800*480) capacitive touch screen LCD
Power & Green Energy Efficiency	Universal power adapter included: Input: 100-240VAC 50-60Hz; Output: 12VDC, 2A (24W)
Temperature and Humidity	Operating: 32 – 104oF / 0 – 40oC Storage: 14 – 140oF / -10 – 60oC Humidity: 10% to 90% Non-condensing
Compliance	FCC: Part 15 (CFR 47) Class B; UL 60950 (power adapter) CE: EN55022 Class B, EN55024, EN61000-3-2, EN61000-3-3, EN60950-1, EN62479, RoHS RCM: AS/ACIF S004; AS/NZS CISPR22/24; AS/NZS 60950; AS/NZS 4268

GETTING STARTED

This chapter provides basic installation instructions including the list of the packaging contents and also information for obtaining the best performance with the GAC2500.

Equipment Packaging

GAC2500

- 1 x GAC2500 Main Case.
- 1 x 12V Power Adapter.
- 1 x Ethernet Cable.
- 1 x Micro-USB Cable.
- 1 x RJ48 CAT.
- 1 x Quick Installation Guide.
- 1 x GPL License.

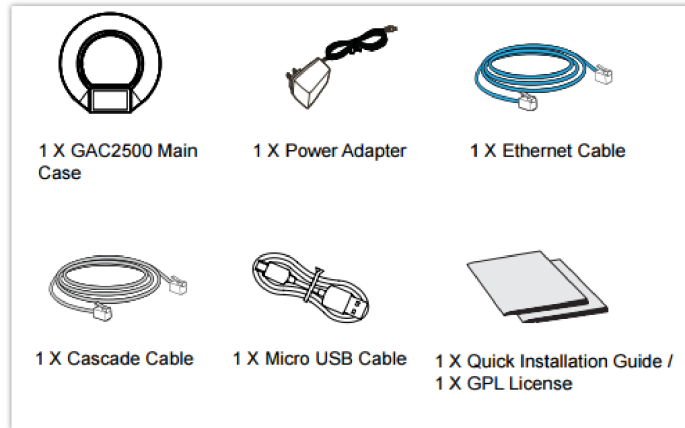

GAC2500 Package Content

Note

Check the package before installation. If you find anything missing, contact your system administrator.

Powering GAC2500

The GAC2500 can be powered either using POE or PSU, please refer to the following picture to have more visibility how to connect your audio conferencing system.

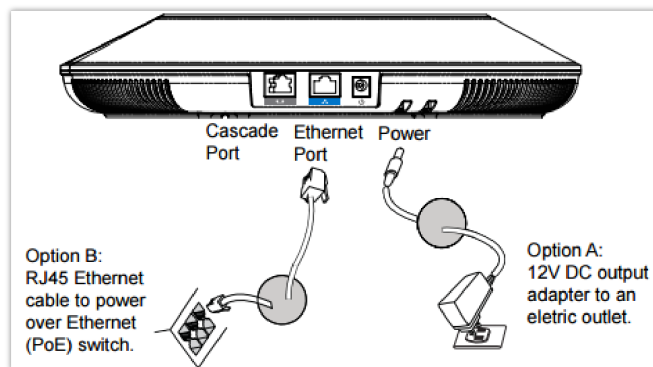

Powering the GAC2500

Connection Configuration

GAC2500 provides 2 connection configurations:

- Standard connection (extendable cascade connection and mobile device connection).
- Integrated connection (slave mode connection).

Standard Connection

1. Connect the LAN port of the GAC2500 to the RJ-45 socket of a hub/switch or a router.
2. Connect the 12V DC output plug to the power jack on the GAC2500; plug the power adapter into an electrical outlet. If PoE switch is used in step 1, this step could be skipped.
3. The LCD will display booting up or firmware upgrading information. Before continuing, please wait for the main screen display to show up.
4. On the web configuration interface or from the menu of the touch screen, you can further configure network connection using static IP, DHCP and etc.

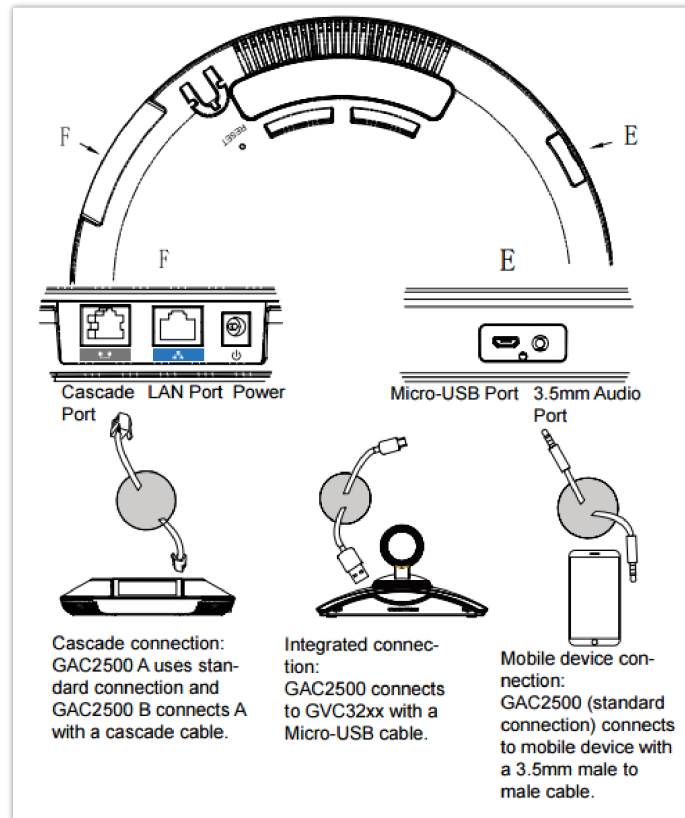

Connecting the GAC2500

Integrated Connection

1. Connect the 12V DC to the power jack on the GAC2500; plug the power adapter into an electrical outlet.
2. After the device boots up, connect the Micro-USB port to the USB port of GVC32xx or PC, as shown above.
3. The LCD will display the cascade connection interface, as shown below

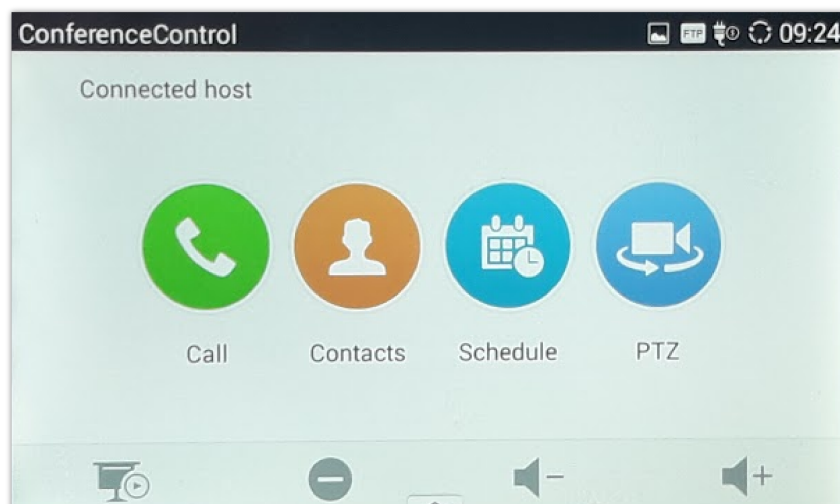

Connection Interface on the GAC2500

4. Adjust the conference settings by tapping the icons on the interface

GAC2500 LCD SETTINGS

Use the Touchscreen

To fully manipulate the GAC2500 capacitive touch screen, use your fingers to operate the following on the GAC2500 icons, buttons, menu items, onscreen keyboard and etc.

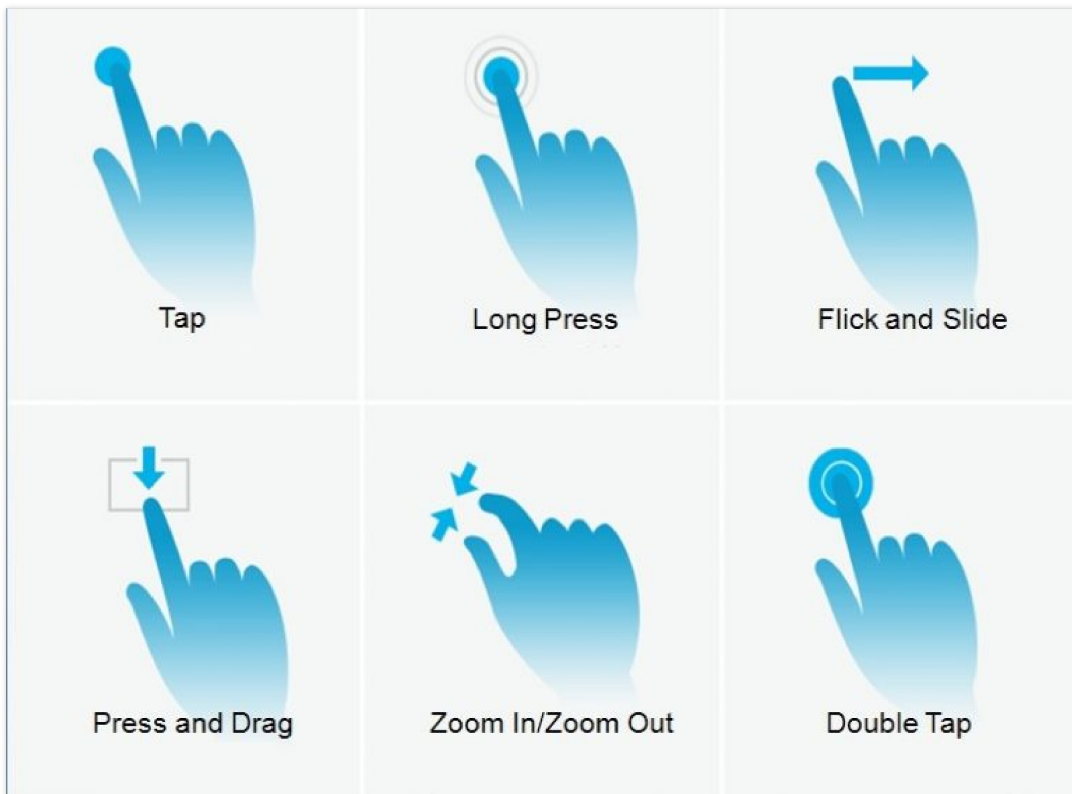

GAC2500 Finger Gestures on the Touch Screen

- **Tap**

Slightly touch the screen with fingertip to initiate menu, options or applications. For example, to select items on the screen (e.g., setting options, apps and etc.); to press onscreen buttons (e.g., "End" or "Options" soft key during the call); to type letters and symbols using the onscreen keyboard.

- **Long Press**

Touch the screen with fingertip and press for about 2 seconds without lifting your finger from the screen till an action occurs. For example, long press on a picture to bring up selection option.

- **Flick and Slide**

Touch the screen with fingertip and slide over the screen. For example, user could slide up to scroll up the page, slide down to open dropdown menu, slide left or slide right to delete an item from the list. If your finger stays on the screen for too long, the item may be selected and sliding won't occur.

- **Press and Drag**

Touch and press the item, then move it by dragging it up, down, left or right, without lifting your finger from the screen.

- **Zoom in/Zoom Out**

Place two fingers on the screen, then pinch them together (zoom out) or spread them apart (zoom in).

- **Double Tap**

Quickly touch the screen twice with fingertip to switch between default display and zoomed-in display. This is usually used when viewing photos or web pages.

When the GAC2500 boots up in HOME screen, the LCD will display as below. A registered account is shown in the following figure and users might need register their own account to have the account status displayed.

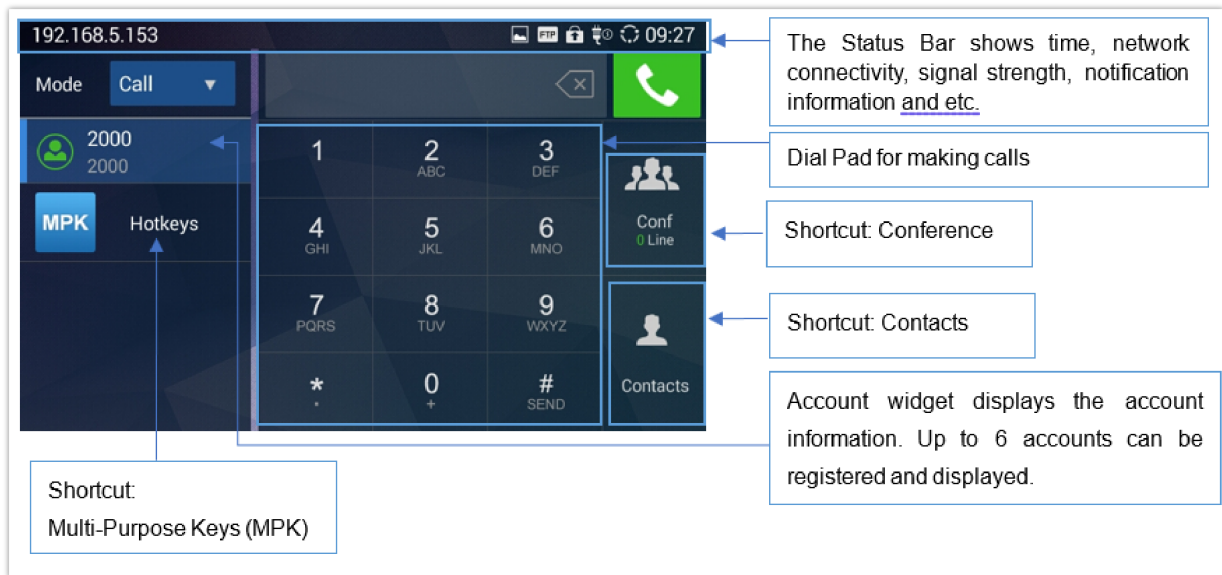

GAC2500 Default Home Screen

The GAC2500 LCD MENU provides easy access to the settings on the phone. Most of the settings from Web GUI could be configured on the LCD settings as well. Go to LCD onscreen MENU and then tap on **Settings shown as follows**.

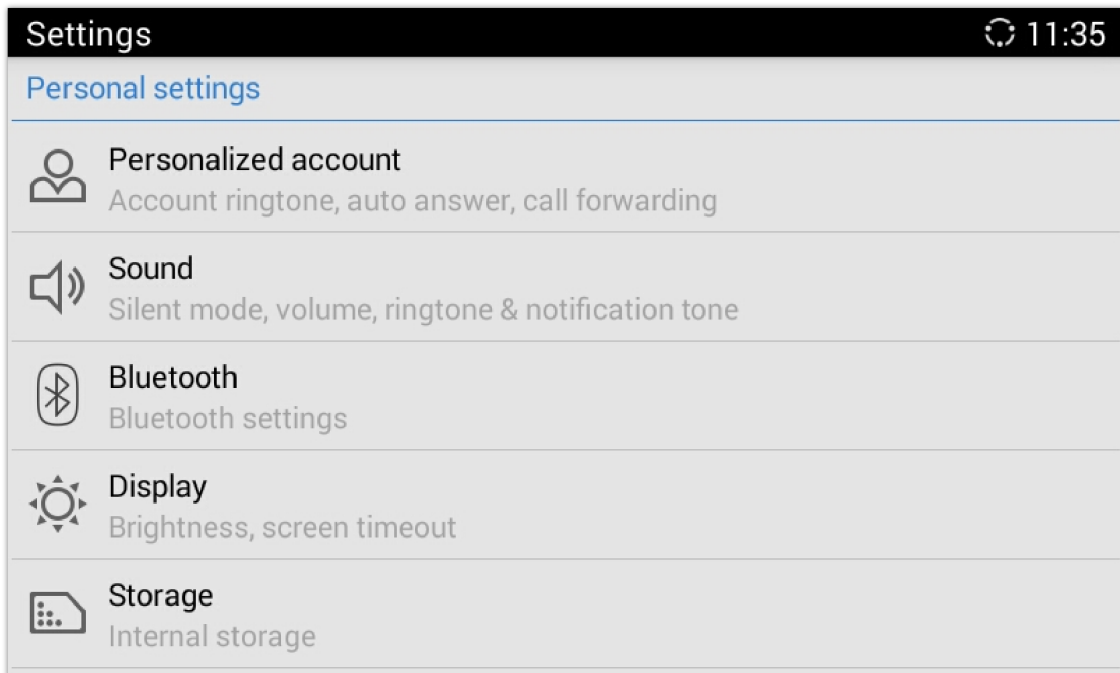

GAC2500 Settings

Personalized Account

In Personalized Account menu, all the accounts will show up with registration status displayed. Tap on one of the account to enter the settings.

- **Ringtone.** Select ring tone for the incoming call. If "Custom Ringtone" is selected, File Manager will be opened for users to choose their own music files to be configured as the incoming call ring tone. Users will see the music file name as the ring tone name in account ring tone settings in LCD as well as in web GUI.
- **Auto-answer.** If it's set to Yes, the GAC2500 will automatically turn on the speakerphone to answer incoming calls. If it's set to Enable Intercom/Paging mode, it will answer the call based on the SIP info header sent from the server/proxy;
- **Call forwarding.** Configures call forwarding mode.

Sound

Use the Sound settings to configure how the GAC2500 rings, plays music or other media with audio, notification ringtones and alarms.

- **Silent mode.** Check to enable mute and uncheck to disable. Once enabled, all audio will be sent to mute except alarm and media.
- **Volumes.** Tap on Volume and scroll left/right to adjust the volume for Ringtone and Media.
- **Device Ringtone.** Defines device ringtone.
- **Notification tone.** Defines notifications ringtone.

Bluetooth

Users can configure Bluetooth connection here.

- **Bluetooth.** Check/uncheck to turn on/off Bluetooth so that you can connect with other Bluetooth devices;
- **Bluetooth settings.** Check/uncheck to turn on/off Bluetooth. Set up Device name, Discoverable, Discoverable timeout, Scan for devices, etc.

Parameters	Descriptions
Paired device	Displays paired devices like Bluetooth remote control, cellphone or speaker.
Available devices	Displays all devices in the search range which have enabled Bluetooth.

Display

- **Brightness.** Tap on **Brightness** and scroll left/right to adjust the brightness on the GAC2500 LCD.
- **Screen timeout.** Tap to open the dialog where you can set the screen timeout interval before the LCD turns dark.
- **Commonly used soft keys guide.** Trigger to enable displaying use guide indicator.

Storage

Display storage status of GAC2500.

Applications

The GAC2500 provides built-in applications for users to fully utilize the phone and features. In this section, the important built-in applications on the GAC2500 are described in detail.

Location Access

Display whether allow to access your location.

Language & Keyboard

- **Language.** Opens a list of language options for GAC2500 to display with.
- **Spell Checker.** Configures whether to check spellings and select the available spell-checker tool.
- **Personal Dictionary.** Adds new words to user's dictionary.
- **Keyboard & Input Methods.** Sets up default input method.

- **Android Keyboard (AOSP).** Sets up whether to use Android keyboard or not, and configure Android keyboard.
- **Text-to-Speech (TTS) output.** Sets up TTS.
- **Mouse/Trackpad.** Sets up the pointer speed.

Account

The GAC2500 allows users to add Google account, Exchange account and Email account to the phone. Once the account is associated, the contacts and other settings can be synced up on the GAC2500. For example, users could download Google Play from GS Market. If there is a Google account set up here already, Google Play will automatically log in with the previously added Google account. The Contact app will display all the contacts stored in the added Google account. Please refer to chapter **Manage Contacts** in *User Manual* for more details.

Date & Time

- **Enable and use specified NTP server address.** Assign the URL or IP Address of NTP Server.
- **Set date.** Set the current date for the GAC2500.
- **Set time.** Set the time on the GAC2500 manually.
- **Select time zone.** Select time zone for the GAC2500.
- **Use 24-hour format.** Check/uncheck to display the time using 24-hour time format or not. For example, in 24-hour format, 13:00 will be displayed instead of 1:00 pm.
- **Choose date format.** Select the format of year, month and day for the date to be displayed.

About Phone

About Phone lists the GAC2500's account information, network status and system information.

- **Account Status.** Displays the account name and registration status on the GAC2500.
- **Network Status.** MAC Address, Address Type, IP Address, Subnet Mask, Default Gateway, DNS Server, Alternative DNS server, NAT Type, VPN IP information will be displayed.
- **System Information.** Displays the system version of the GAC2500.

Advanced Settings

Users could open Advanced settings to set up advanced features for Account, configure Upgrade settings, Syslog and perform Factory Reset.

- **Account.** Tap on one account and fill in the necessary information to register the account, which includes Account Active, Account Name, SIP Server, SIP User ID, SIP Auth ID, SIP Auth Password, Voice Mail User ID and Display Name.
- **Wireless & network.** Users can configure Ethernet, Wi-Fi, VPN, PPPoE and other advanced settings.

Users can configure Ethernet, Wi-Fi, VPN, PPPoE and other advanced settings under **Network**.

- **Security settings.** Configure the idle screen lock, credential management, encryption phone and device administrator, etc.
- **Upgrade.** Fill in upgrade info.
- **Syslog.** Select the level of logging for syslog, and the URL/IP address for the syslog server.
- **Factory Reset.** Open and tap on Factory Reset to restore the GAC2500 to factory default settings.
- **Clear Master-slave Remember.** Clear master-slave choose history.
- **Developer mode.** This mode can be used via ADB tool for advanced debugging purpose.

Parameters	Descriptions
------------	--------------

Account	Select account.
Account Activation	Indicates whether the account is active. If disabled, the GAC2500 will not send registration information to SIP server.
Account Name	Configures the name associated with account to be displayed on the upper left corner of LCD.
SIP Server	Specifies the URL or IP address, and port of the SIP server. This is provided by your VoIP service provider (ITSP).
SIP User ID	Configures user account information provided by your VoIP service provider (ITSP). It's usually in the form of digits similar to phone number or actually a phone number.
SIP Authentication ID	Configures the SIP service subscriber's Authenticate ID used for authentication. It can be identical to or different from the SIP User ID.
SIP Authentication Password	Configures the account password required for the phone to authenticate with the ITSP (SIP) server before the account can be registered. After saving, it will appear as hidden for security purpose.
Voice mail access number	Sets if the phone system allows users to access the voice messages by pressing the Voicemail icon on the GAC2500. For example, in UCM6xxx IPPBX, *97 could be used.
Display Name	Specifies the SIP server subscriber's name (optional) that will be used for Caller ID display. The configured content will be included in the "From", "Contact" and "P-Preferred-Identity" headers of SIP INVITE message.
Show account name only	Displays the account name; if it is checked, the user ID will be hidden and the account name will be displayed only.
Tel URI	Sets this field to "" User=Phone", If the account is assigned a PSTN number. Then a "User=Phone" parameter will be attached to the Request-Line and TO" header in the SIP request to indicate E.164 number. If set to "Enabled", "Tel" will be used instead of "SIP". Default is "Disabled".

Account Settings Parameters

Parameters	Descriptions
Server name	UCM Server name.
Server URL	UCM Sever URL.
Port	UCM server port.
Access mode	Access mode to the UCM, default is HTTP.

UCM Auto Config Number

Parameters	Descriptions
Address Type	Allows users to configure the appropriate network settings on the device. Users could select "DHCP", "Static IP" or "PPPoE".
IP Address	Enters the IP address when static IP is used.

Subnet Mask	Enters the subnet mask when static IP is used.
Default Router	Enters the default router when static IP is used.
DNS Server 1	Enters the DNS Server 1 address when static IP is used.
DNS Server 2	Enters the DNS Server 2 address when static IP is used.
PPPoE Account ID	Enters the PPPoE account ID when PPPoE is used.
PPPoE Password	Enters the PPPoE password when PPPoE is used.
Parameters	Descriptions
IPv6 address type	Allows users to configure the appropriate network settings on the device. Users could select “DHCP” or “Static IP”.
Static IPv6 address	Enters the IP address when static IP is used.
IPv6 prefix length	Enters the IPv6 prefix length when static IP is used.

Ethernet IPv4 Settings Parameters

Parameters	Descriptions
Enable/Disable Wi-Fi	Enable/disable Wi-Fi. Once enabled, the device will search for available Wi-Fi nearby automatically and display below.

Wi-Fi Settings Parameters

Parameters	Descriptions
Name	Identify VPN network, fill in company name or server name you are connecting to.
Type	Defines VPN type. By default, it's PPTP (Point to Point Tunneling Protocol).
Server Address	Fill in the VPN server URL or IP address.
PPP Encryption (MPPE)	Defines whether to use PPP encryption.
Show Advanced Options	Check to display more options below.
DNS Search Domain	Defines search domain.
DNS Server	Fill in DNS Server address.
Forwarding Routes	Fill in DNS. For example, 10.0.0.0/8

VPN Settings Parameters

Parameters	Descriptions
------------	--------------

HTTP/HTTPS Proxy Hostname	Configures the HTTP/HTTPS proxy URI of the network.
HTTP/HTTPS Proxy Port	Configures the HTTP/HTTPS proxy port number of the network.
Bypass proxy for	Defines the specific URI that the GAC2500 can directly access to without HTTP/HTTPS proxy.

Proxy Settings Parameters

Parameters	Descriptions
LLDP	Enable or disable LLDP. The default setting is disabled.
Layer 3 QoS for SIP	This field defines the layer 3 QoS parameter for SIP packets. It is the value used for IP Precedence, Diff-Serv or MPLS. The Default value is 48.
Layer 3 QoS for Audio	This field defines the layer 3 QoS parameter for audio packets. It is the value used for IP Precedence, Diff-Serv or MPLS. The Default value is 48.
Layer 2 QoS 802.1q/VLAN Tag (Ethernet)	Assigns the VLAN Tag of the Layer 2 QoS packets for LAN port. Default value is 0. Note: Please do not change the setting before understanding the VLAN's settings or consulting the network administrator. Otherwise, the device might not be able to get the correct IP address.
Layer 2 QoS 802.1p Priority (Ethernet)	Assigns the priority value of the Layer 2 QoS packets. The default value is 0.
Layer 2 QoS 802.1q/VLAN Tag (Wi-Fi)	Assigns the VLAN Tag of the Layer 2 QoS packets for Wi-Fi. Default value is 0.
Layer 2 QoS 802.1p Priority (Wi-Fi)	Assigns the priority value of the Layer 2 QoS packets. The default value is 0.
802.1x mode	Allows the user to enable/disable 802.1x mode on the device. Configures 802.1x authentication when connecting to the authentication server. The default setting is "Close".
Identity	Enter the Identity information for the 802.1x mode.
MD5 Password	Enter the MD5 Password for the 802.1x mode.
CA Certificate	Upload the CA certificate for the 802.1x mode.
Client Certificate	Upload the client certificate for the 802.1x mode.
Private Key	Upload the private key for the 802.1x mode.

Additional Network Settings Parameters

Parameters	Descriptions
Screen lock	Display paired devices like Bluetooth remote control, cellphone or speaker.
Owner info	Set up display owner info on lock screen.

Encrypt phone	Set up input digit PIN or password to unlock the GAC2500 each time you boot.
Display passwords	Check/uncheck to show/hide password as you type.
Device administrators	Add or remove device administrators.
Unknown sources	Check/uncheck to enable/disable permission to install applications that you obtain from web sites, email, or other locations other than GS Market and Google Play.
Verify apps	Disable or warn the users before apps installation.
Trusted credentials	Check/uncheck to allow/disallow applications to access secure certificates and other credentials.
Install from SD card	Install encrypted certificates from SD card.
Clear credentials	Clear credential storage of all contents and reset its password.

Security Settings Parameters

Reboot

Tap on "Reboot" to reboot the device.

GAC2500 WEB GUI SETTINGS

The GAC2500 embedded Web server responds to HTTP/HTTPS GET/POST requests. Embedded HTML pages allow users to configure the application device through a Web browser such as Mozilla Firefox, Google Chrome™ and etc.

Accessing GAC2500 Web GUI

The IP address of GAC2500 displays on LCD display screen. To access the GAC2500 Web GUI:

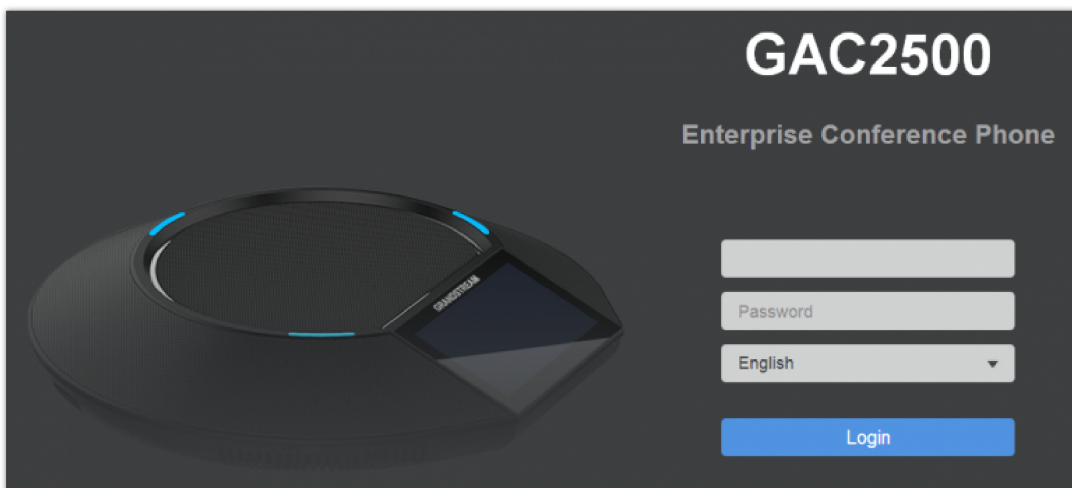

1. Connect the computer to the same network with GAC2500.
2. Open a Web browser on your computer, enter the phone's IP address in the address bar of the browser; for example: <http://192.168.124.111>;
3. Enter the administrator's login and password to access the Web Configuration Menu. The default username and password are: admin, admin; you can set language to English or Chinese in the drop-down menu of language;



Web UI – Login

4. Click "Login" to access the configurations in web UI.

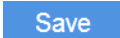
Saving Changes

When changing any settings on the web UI, always submit them by pressing the Save button  on the bottom of the page, and then clicking the Apply button  on the top of the page to apply the configuration changes. For those options with  next to it in the Web page, users must reboot the GAC2500 for the changes to take effect.

Definitions

This section describes the 6 options in the GAC2500 Web GUI. Please view Advanced, Maintenance and Status specifications in Administration Guide.

- **Call**

Users could start conference and control conference from Web GUI.

- **Contacts**

Contacts, Schedule, Call History.

- **Account**

Configure account info.

- **Advanced**

General Settings, Call Features, Tone Generator, MPK General Settings, MPK LCD Settings.

- **Maintenance**

Network Settings, Time & Language, Security Settings, Upgrade, Troubleshooting, Device Manager.

- **Status**

Account Status, Network Status, System Info, and Storage Info.

You can log in as an administrator or a normal user. The following table shows the web pages accessible by normal user and administrator.

User Type	Username	Default Password	Accessible Web Pages
Normal User	user	123	<ul style="list-style-type: none">• Call• Contacts• Account: Call Settings• Advanced: MPK General Settings, MPK LCD Settings• Maintenance: Network Settings, Time & Language, Security Settings, Device Manager• Status: Account Status, Network Status, System Info
Administrator	admin	admin	All pages.

GAC2500 Users Access Permission

Toolbar

The web UI tool bar is on the upper right corner of the web UI page.

Web UI – Tool Bar

o **DND**

Turn on/off DND mode. Once enabled, the DND text will turn into red and all incoming calls will be rejected.

o **English**

Select the display language for the web UI.

o **Reboot**

Reboot the device.

o **Expert**

Click to switch to expert mode and click again to cancel. Once enabled, the administrator can view all settings items.

o **Logout**

Log out from the web UI.

Contacts Page Definitions

Contacts page lists Contacts, Schedule, Call History and LDAP Settings.

Contacts – Contacts

Users can make the following operations on the GAC Contacts page:

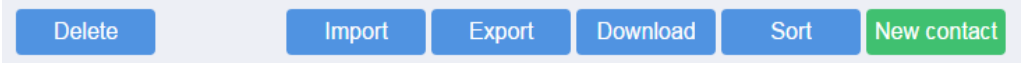

o **Delete**

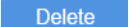
Select one or more contacts, then click  in order to remove contacts from the web GUI.

o **Import**

Clear the old list	Click on the checkbox in order to clear old list.
Clear old history mode	Select either to clear all old history or clear only reserved local contacts.
Replace duplicate entries	Click the checkbox in order to replace duplicate entries.
Replace duplicate entries mode	Select how to replace duplicate entries, either by name or by number.
File encoding	Chose the encoding type of the file, following are available: UTF-8 GBK UTF-16 UTF-32 Big5 Big5-HKSCS Shift-JIS ISO8859-1 ISO8859-15 Windows-1251

	EUC-KR
File type	Choose the file type from the drop down, following are available: XML VCard CSV
Browse	Brows to import a contact file.

Contacts – Import

○ **Export**

File encoding	Chose the encoding type of the file, following are available: UTF-8 GBK UTF-16 UTF-32 Big5 Big5-HKSCS Shift-JIS ISO8859-1 ISO8859-15 Windows-1251 EUC-KR
File type	Choose the file type to export to from the drop down, following are available: XML VCard CSV
Export	Click Browse to select a directory where to export the contact file.

Contacts – Export

○ **Download**

Clear the old list	Click on the checkbox in order to clear old list.
Clear old history mode	Select either to clear all old history or clear only reserved local contacts.
Replace duplicate entries	Click the checkbox in order to replace duplicate entries.
Replace duplicate entries mode	Select how to replace duplicate entries, either by name or by number.
Download mode	Choose the download mode from the drop down, available are: Off TFTP HTTP HTTPS Note: if Off is selected remote download will be deactivated.
File encoding	Chose the encoding type of the file, following are available: UTF-8 GBK

	UTF-16 UTF-32 Big5 Big5-HKSCS Shift-JIS ISO8859-1 ISO8859-15 Windows-1251 EUC-KR
Download interval	Choose the download interval from the drop-down list, available are: 2 Hours 4 Hours 6 Hours 8 Hours 12 Hours
Username	Enter the username of the remote server.
Password	Enter the password of the remote server.
Download server	Enter the domain name, the IPv4 or the IPv6 address of the download server.
download	Click download to download the contact file.

Contacts – Download

○ **Sort**

Users can either sort contacts by **Last Name** or **First Name**.

○ **New Contact**

Name	Enter last name and first name of the new contact.
Number	Select the account and enter the number of the new contact.
Email	Enter the email of the new contact.
Groups	Select the group where the set the new contact.

Contacts – New Contact

Contacts – Groups

Users can delete or create a new group by clicking on [Delete](#) or [New group](#) .

Name	Enter the name of the group.
Group Ringtone	Select a ringtone form the drop-down list.
Group Members	Select members of the group.

Contacts – Groups

Contacts – Blacklist

Users could do the following operation on the GAC blacklist:

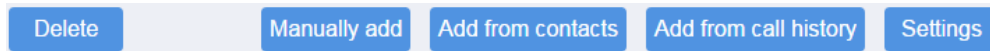

- **Delete**

Delete blacklisted numbers.

- **Manually add**

Number	Enter the number to black list.
Note(optional)	Add a note regarding that number.

Contacts – Blacklist – Manually add

- **Add from contacts**

Users can add blacklist numbers from contacts.

- **Add from call history**

Users can add blacklist numbers from call history.

- **Settings**

DND mode	Select whether to activate or deactivate DND mode.
Block mode	Select to open or close the block mode.
Block options	Select a block option from the drop-down list, available are: Block all Block blacklist only Block anonymous Block anonymous and blacklist
Block notification	Set block notification to either open or close.
Time settings	Select time settings for the block mode.
Start time	Enter the start time of the block mode.
End time	Enter the end time of the block mode.

Contacts – Settings

Contacts – Schedule

Conference name	Enter a conference name.
Members of conference	Select members of conference.

Recurring conference	Select in order to enable the conference repeat and how often to repeat the conference from the drop-down list.
Start date	Select the conference start date.
End date	Select whether to repeat the conference indefinitely or set an end date.
Conference date	If recurring conference is not selected, set the start date of the conference.
Time zone	Select the time zone.
Start time	Select the start time of the conference.
Conference duration (Min)	Select the conference duration in minutes.
Remind time	Select to send a reminder before the conference start.
Auto conference	Select to enable auto conference.
Auto answer for conference members	Select to auto answer for conference members.
Block when enter	Select to block when enter.
Block calls not from members in schedule	Select to block call not incoming from members.
Password	Enter the conference password.
Auto record	Select to auto record.

Contacts – Schedule

Contacts – Call History

Users can browse all history calls, missed and intercepted records.

Contacts – LDAP

Connection Mode	Select which protocol will be used for LDAP searching, LDAP or LDAPS.
Server Address	Configures the URI of the LDAP (Lightweight Directory Access Protocol) server.
Port	Configures the LDAP server port. The default LDAP port number is 389.
Base DN	Determines the LDAP search base. This is the location in the directory where the search is requested to begin. Example: dc=grandstream, dc=com ou=Boston, dc=grandstream, dc=com
User Name	Configures the bind “Username” for querying LDAP servers. Some LDAP servers allow anonymous binds in which case the setting can be left blank.

Password	Specifies the bind “Password” for querying LDAP servers. The field can be left blank if the LDAP server allows anonymous binds.
LDAP Name Attributes	Configures the “name” attributes of each record which are returned in the LDAP search result. This field allows the users to configure multiple space separated name attributes. Example: gn cn sn description
LDAP Number Attributes	Configures the “number” attributes of each record which are returned in the LDAP search result. This field allows the users to configure multiple space separated number attributes. Example: telephoneNumber telephoneNumber Mobile
LDAP Mail Attributes	Determines the “mail” attributes of each record which are returned in the LDAP search result. Example: mail
Search filed filter	Configures to filter according to which fields when LDAP search. The default setting is “Filter All”.
LDAP Name Filter	Configures the filter used for name lookups. Examples: ((cn=%)(sn=%)) returns all records which has the “cn” or “sn” field starting with the entered prefix; (!(sn=%)) returns all the records which do not have the “sn” field starting with the entered prefix; (&(cn=%) (telephoneNumber=*)) returns all the records with the “cn” field starting with the entered prefix and “telephoneNumber” field set.
LDAP Number Filter	Defines the filter used for number lookups. Examples: ((telephoneNumber=%)(Mobile=%)) returns all records which has the “telephoneNumber” or “Mobile” field starting with the entered prefix; (&(telephoneNumber=%) (cn=*)) returns all the records with the “telephoneNumber” field starting with the entered prefix and “cn” field set.
LDAP Mail Filter	Determines the filter used for mail lookups. Example: (mail=%)
LDAP Displaying Name Attributes	Configures the entry information to be shown on phone’s LCD. Up to 3 fields can be displayed. Example: %cn %sn %telephoneNumber
Max Hits	Specifies the maximum number of results to be returned by the LDAP server, valid range from 0 to 4000. If set to 0, server will return all search results. Default setting is 50.
Search Timeout (ms)	Configures the interval (in seconds) for the server to process the request and client waits for server to return. The default setting is 4000 seconds.
LDAP Lookup For Outgoing Call	Sets the phone system to do the LDAP number searching when making outgoing calls. The default setting is “No”.
LDAP Lookup For Incoming Call	Sets the phone system to do LDAP number searching for incoming calls. The default setting is

	“No”.
LDAP Dialing Default Account	Configures the default account that being used when dialing LDAP contact. Users may choose the Account 1-6, the default setting is “Default”.

Contacts – LDAP

Contacts – BroadSoft

The BroadWorks XSI Directories and Call Logs configuration is completed by the BroadWorks server administrator or service provider. End users should be given Xsp server URI and user credentials to access the service.

1. Log in Web GUI and go to Contacts → BroadSoft.
2. Register the BroadWorks account on the phone:
 - Fill the BroadWorks XSP server address in the Server blank. If the BroadWorks Xsp server requires to use the HTTPS, please add the header “https://” ahead of BroadWorks Xsp server URI. For example, “https://xsp1.iop1.broadworks.net”.
 - Fill the XMPP port number in the “Port” blank. The default port number is 80. If the BroadWorks Xsp server requires to use the HTTPS, please fill the HTTPS port number “443” in the blank.
 - Based on Authentication Type, fill in different authentication information. LogIN Credentials: Fill the BroadWorks XSI credentials in BroadWorks UserID and Password blanks. SIP Credentials: Fill the SIP Authentication ID in SIP Authentication ID, and fill the SIP User ID in BroadWorks UserID. Users also need to fill the SIP Authentication Password in Password.
 - Fill in the action path in Action Path blank.

BroadWorks XSI Settings

- If users need to use the selected Directory or Call Log categories, please set the categories as “Enabled”, for example, “Group”, “Enterprise”, and “Personal” are checked as below.

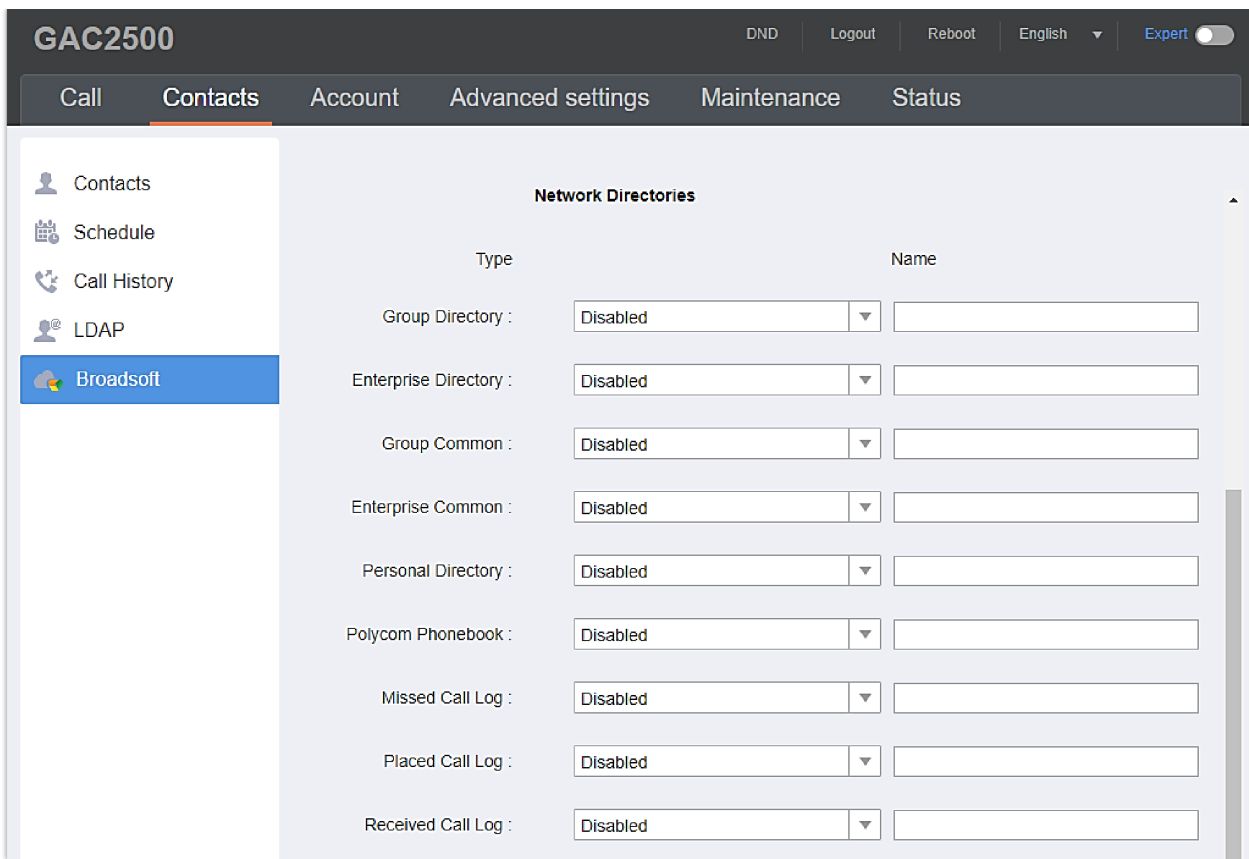

BroadWorks XSI Network Directories

- End user is able to rename each directory or call log category. If user types a string into the blank, it will override the default name. For example, the Group Directory's default name is "Group" if it keeps blank. If the user fills "Grandstream" into the blank, the phone will display "Grandstream" for the Group Directory.

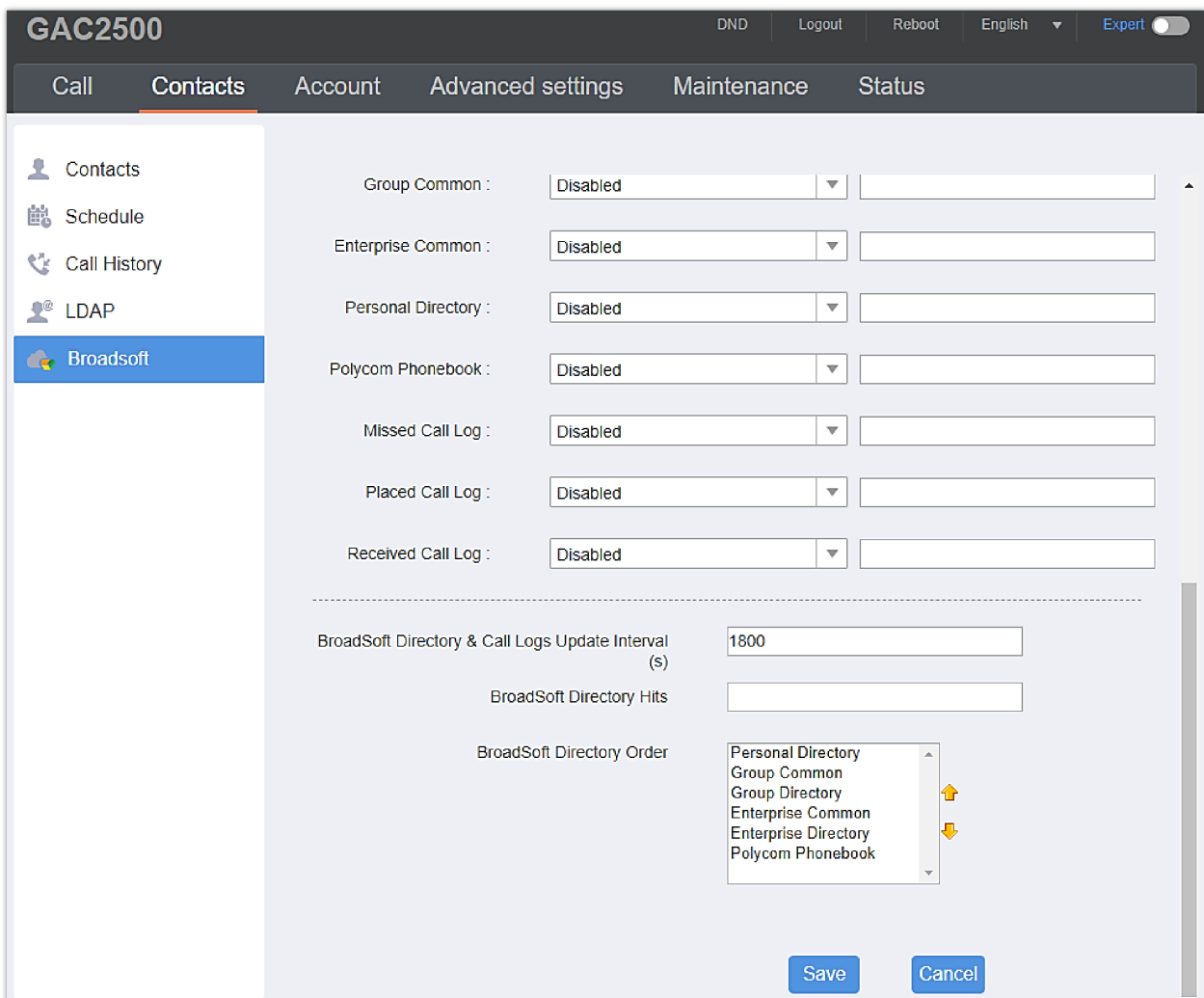

BroadSoft Directory additional settings

3. After filling the information, open Contact app on the GAC2500 and click BroadSoft contacts.

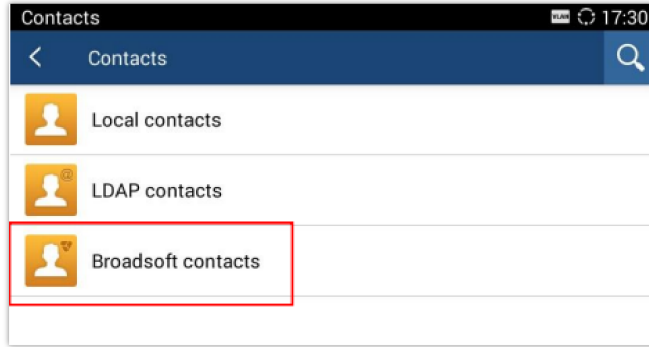

Contact App

4. The correct login information would display the list of contacts, under different groups selected before.

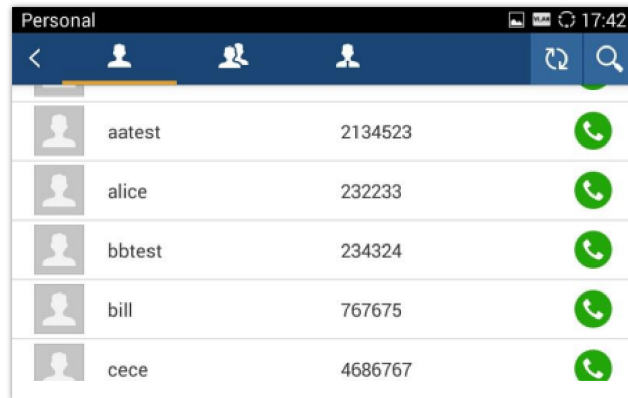

BroadSoft contacts list

Account Settings Page Definitions

GAC2500 supports 6 accounts, The Account pages lists General Settings, Network Settings, SIP Settings, Codec & RTP Settings and Call Settings.

Account – General Settings

Account Active	Indicates whether the account is active. The default value for the primary Account 1 is “Yes” and the default value for the other five accounts is “No”.
Account Name	Configures the name associated with each account to be displayed on the LCD.
SIP Server	Specifies the URL or IP address, and port of the SIP server. This is provided by your VoIP service provider (ITSP).
SIP User ID	Configures user account information provided by your VoIP service provider (ITSP). It’s usually in the form of digits similar to phone number or actually a phone number.
SIP Authentication ID	Configures the SIP service subscriber’s Authenticate ID used for authentication. It can be identical to or different from the SIP User ID.
SIP Authentication Password	Configures the account password required for the phone to authenticate with the ITSP (SIP) server before the account can be registered. After saving, it will appear as hidden for security purpose.
Voice Mail Access Number	Sets if the phone system allows users to access the voice messages by pressing the Voicemail icon on the GAC2500. For example, in UCM6xxx IPPBX, *97 could be used.

Name	The SIP server subscriber's name (optional) that will be used for Caller ID display.
Show Account Name Only	Defines whether to display account name and SIP User ID, if check, it only displays account name on account area.
Tel URI	If the phone has an assigned PSTN telephone number, this field should be set to "User=Phone". Then a "User=Phone" parameter will be attached to the Request-Line and "TO" header in the SIP request to indicate the E.164 number. If set to "Enable", "Tel:" will be used instead of "SIP:" in the SIP request. The default setting is "Disable".

Account – General Settings

Account – Network Settings

Outbound Proxy	Configures the IP address or the domain name of the primary outbound proxy, media gateway or session border controller. It's used by the phone for firewall or NAT penetration in different network environments. If a symmetric NAT is detected, STUN will not work and only an outbound proxy can provide a solution
Secondary Outbound Proxy	Sets IP address or domain name of the secondary outbound proxy, media gateway or session border controller. The phone system will try to connect the Secondary outbound proxy only if the primary outbound proxy fails.
DNS Mode	<p>Defines which DNS service will be used to lookup IP address for SIP server's hostname. It can be selected from the dropdown list:</p> <p>A Record SRV NATPTR/SRV</p> <p>If it needs DNS SRV resource, which DNS server response more than one result, it should be set to "SRV" or "NATPTR/SRV".</p> <p>The default setting is "A Record".</p>
DNS SRV Fail-over Mode	<p>Configure the preferred IP mode for DNS SRV.</p> <ul style="list-style-type: none"> • If "default" is selected, first IP from query result will be applied. • If "Saved one until DNS TTL" is selected, first IP will be applied before reaches DNS timeout. • If "Saved one until no response" is selected, first IP will be applied even after DNS times out until it cannot response.
NAT Traversal	<p>Specifies which NAT traversal mechanism will be enabled on the phone system. It can be selected from the dropdown list:</p> <p>NAT NO STUN Keep-alive UPnP Auto VPN</p> <p>If the outbound proxy is configured and used, it can be set to "NAT NO".</p> <p>If set to "STUN" and STUN server is configured, the phone system will periodically send STUN message to the SUTN server to get the public IP address of its NAT environment and keep the NAT port open. STUN will not work if the NAT is symmetric type.</p> <p>If set to "Keep-alive", the phone system will send the STUN packets to maintain the connection that is first established during registration of the phone. The "Keep-alive" packets will fool the NAT device into keeping the connection open and this allows the host server to send SIP requests directly to the registered phone.</p> <p>If it needs to use OpenVPN to connect host server, it needs to set it to "VPN". If the firewall and the SIP device behind the firewall are both able to use UPNP, it can be set to "UPNP". The</p>

Proxy-Require	both parties will negotiate to use which port to allow SIP through. The default setting is “Keep-Alive”. Adds the Proxy-Required header in the SIP message. It is used to indicate proxy-sensitive features that must be supported by the proxy. Do not configure this parameter unless this feature is supported on the SIP server.
----------------------	-----------------------------------------------------------------------------------------------------------------------------------------------------------------------------------------------------------------------------------------------------------------------------------------------------------------------------------------

Account – Network Settings

Account – SIP Settings

SIP Registration	Allows the phone system to send SIP REGISTER messages to the proxy/server. The default setting is “Yes”.
Unregister before new registration	Controls whether to clear SIP user’s information by sending un-register request to the proxy server. When set to “All”, the un-registration is performed by sending a REGISTER message with “Contact” header set to * and Expires=0 parameters to the SIP server when the phone starts pre-registration after rebooting. If set to “Instance”, the phone only cleans the current SIP user’s info by sending REGISTER message with “Contact” header set to concerned SIP user’s info and Expires=0 parameters to the SIP server. The default setting is “Instance”.
Register Expiration (m)	Configures the time period (in minutes) in which the phone refreshes its registration with the specified registrar. The default setting is 60. The maximum value is 64800 (about 45 days).
Re-register before Expiration (s)	Specifies the time frequency (in seconds) that the phone sends re-registration request before the Register Expiration. The default setting is 0. The range is from 0 to 64,800.
Wait Time Retry Registration (s)	Configures the time period (in seconds) in which the phone will retry the registration process in the event that is failed.
Local SIP Port	Defines the local SIP port used to listen and transmit. The default setting is 5060 for Account 1, 5062 for Account 2, 5064 for Account 3, 5066 for Account 4, 5068 for Account 5, and 5070 for Account 6.
SUBSCRIBE for MWI	Configures the phone system to subscribe voice message service. If it is set to “Yes”, the phone system will periodically send SIP SUBSCRIBE message for Message Waiting Indication service. GAC2500 phone system supports both synchronized and non-synchronized MWI. The default setting is “No”.
Enable OPTIONS Keep Alive	Configures whether to use OPTIONS to query account registration status. If enabled, the device will send OPTIONS query message and the connection status with sever regularly to server. The default setting is “No”.
OPTIONS Keep Alive Interval (s)	Sets the time interval the device sends the OPTIONS message to server. The default setting is 30 seconds, which means the device sends the OPTIONS message to server every 30 seconds. The effective range is 1- 64800.
OPTIONS Keep Alive Maximum Tries	Configures the maximum times of sending OPTIONS message consistently from the phone to server. Phone will keep sending OPTIONS messages until it receives response from SIP server. The default setting is “3”, which means when the device sends OPTIONS message for 3 times, and SIP server does not respond this message, the phone will send RE-REGISTER message to register again. The valid range is 3-10.
Enable Session Timer	Allows the phone system to use the session timer, when set to “Yes”, it will be added in the SIP INVITE message to notify the server.

Session Expiration (s)	Configures the phone system's SIP session timer. It enables SIP sessions to be periodically "refreshed" via a SIP request (UPDATE, or re-INVITE). If there is no refresh via an UPDATE or re-INVITE message, the session will be terminated once the session interval expires. Session Expiration is the time (in seconds) where the session is considered timed out, provided no successful session refresh transaction occurs beforehand. The default setting is 180. The valid range is from 90 to 64800.
Min-SE (s)	Determines the minimum session expiration timer (in seconds) if the phone act as a timer refresher. The default setting is 90. The valid range is from 90 to 64800.
UAC Specify Refresher	Sets which party will refresh the active session if the phone makes outbound calls. If it is set to "UAC" and the remote party does not support Refresher feature, the phone system will refresh the active session. If it is set to "UAS", the remote party will refresh it. If it is set to "Omit", the header will be omitted so that it can be selected by the negotiation mechanism. The default setting is "Omit".
UAS Specify Refresher	Specifies which party will refresh the active session if the phone receives inbound calls. If it is set to "UAC", the remote party will refresh the active session. If it is set to "UAS" and the remote party does not support refresh feature, the phone system will refresh it. The default setting is "UAC".
Force INVITE	Sets the SIP message type for refresh the session. If it is set to "Yes", the Session Timer will be refreshed by using the SIP INVITE message. Otherwise, the phone system will use the SIP UPDATE or SIP OPTIONS message. Default is "No".
Caller Request Timer	Sets the caller party to act as refresher by force. If set to "Yes" and both party support session timers, the phone will enable the session timer feature when it makes outbound calls. The SIP INVITE will include the content "refresher=uac". The default setting is "No".
Callee Request Timer	Sets the callee party to act as refresher by force. If set to "Yes" and the both parties support session timers, the phone will enable the session timer feature when it receives inbound calls. The SIP 200 OK will include the content "refresher=uas". The default setting is "No".
Force Timer	Configures the session timer feature on the phone system by force. If it is set to "Yes", the phone will use the session timer even if the remote party does not support this feature. If it is set to "No", the phone will enable the session timer only when the remote party supports this feature. To turn off the session timer, select "No". The default setting is "No".
Enable 100rel	Activates PRACK (Provisional Acknowledgment) method. PRACK improves the network reliability by adding an acknowledgement system to the provisional Responses (1xx). It is set to "Yes", the phone system will response to the 1xx response from the remote party. Default is "No".
Caller ID Display	Specifies which header tag will be used from the SIP INVITE message for the Caller ID display. If it is set to Auto, the phone system will use the one of the available headers in the priority hierarchy of P-Asserted Identify Header, Remote-Party-ID Header and FROM Header. If it is set to "From Header", it will use the FROM header information for the Caller ID. If it is set to "Disabled", all the incoming calls Caller ID will be displayed with "Unavailable". Default setting is "Auto".
Use Privacy Header	Determines if the Privacy header will be presented in the SIP INVITE message and if it includes the caller info in this header. If it is set to "Default", the Privacy Header will be omitted in INVITE when "Huawei IMS" special feature is active. If set to "Yes", it will always be presented. If set to "No", it will always be omitted. The default setting is "Default".
Use P-Preferred-Identity Header	Specifies if the P-Preferred-Identity Header will be presented in the SIP INVITE message. If set to "default", the P-Preferred-Identity Header will be omitted in SIP INVITE message when "Huawei IMS" special feature is active. If set to "Yes", the P-Preferred-Identity Header will always be presented. If set to "No", it will be omitted. The default setting is "Default".

SIP Transport	Determines which network protocol will be used to transport the SIP message. It can be selected from TCP/UDP/TLS. Default setting is “UDP”.
SIP URI Scheme When using TLS	Determines the port information in the Via header and Contact header of SIP message when the phone system use TCP or TLS. If set to No, these port numbers will use the permanent listening port on the phone. Otherwise, they will use the ephemeral port for the particular connection. The default setting is “No”.
Use Actual Ephemeral Port in Contact with TCP/TLS	Determines the port information in the Via header and Contact header of SIP message when the phone system use TCP or TLS. If set to No, these port numbers will use the permanent listening port on the phone. Otherwise, they will use the ephemeral port for the particular connection. The default setting is “No”.
Symmetric RTP	Configures if the phone system enables the symmetric RTP mechanism. If it is set to “Yes”, the phone system will use the same socket/port for sending and receiving the RTP messages. The default setting is “No”.
RTP IP Filter	Receives the RTP packets from the specified IP address and Port by communication protocol. If it is set to “IP Only”, the phone only receives the RTP packets from the specified IP address based on the communication protocol; If it is set to “IP and Port”, the phone will receive the RTP packets from the specified IP address with the specified port based on the communication protocol. The default setting is “Disable”.
Support SIP Instance ID	Determines if the phone system will send SIP Instance ID. The SIP instance ID is used to uniquely identify the device. If set to “Yes”, the SIP Register message Contact header will include +sip.instance tag. The default setting is “Yes”
Validate Incoming SIP Messages	Specifies if the phone system will check the incoming SIP messages caller ID and CSeq headers. If the message does not include the headers, it will be rejected. The default setting is “No”.
Check SIP User ID for Incoming INVITE	Configures the phone system to check the SIP User ID in the Request URI of the SIP INVITE message from the remote party. If it doesn't match the phone's SIP User ID, the call will be rejected. The default setting is “No”.
Authenticate Incoming INVITE	Configures the phone system to authenticate the SIP INVITE message from the remote party. If set to “Yes”, the phone will challenge the incoming INVITE for authentication with SIP 401 Unauthorized response. The default setting is “No”.
Only Accept SIP Requests from Known Servers	Answers the SIP request from saved servers when set to “Yes”, only the SIP requests from saved servers will be accepted; and the SIP requests from the unregistered server will be rejected. The default setting is “No”.
Allow SIP Reset	Configures whether to allow SIP Notification message to perform factory reset on the phone. The default setting is “No”.
SIP T1 Timeout	Defines an estimate of the round-trip time of transactions between a client and server. If no response is received in T1, the figure will increase to 2*T1 and then 4*T1. The request re-transmit retries would continue until a maximum amount of time define by T2. The default setting is 0.5 sec.
SIP T2 Interval	Specifies the maximum retransmit time of any SIP request messages (excluding the SIP INVITE message). The re-transmitting and doubling of T1 continues until it reaches the T2 value. The default setting is 4 sec.

SIP Timer D Interval	Defines the amount of time that the server transaction can remain when unreliable response (3xx-6xx) received. The valid value is 0-64 seconds. The default value is 0.
Remove OBP from Route	Configures the phone system to remove the outbound proxy URI from the Route header. This is used for the SIP Extension to notify the SIP server that the device is behind a NAT/Firewall. If it is set to “Yes”, it will remove the Route header from SIP requests. The default setting is “No”.
Check Domain Certificates	Sets the phone system to check the domain certificates if TLS/TCP is used for SIP Transport. The default setting is “No”.
Validate Certification Chain	Configures whether to validate certification chain, when TLS/TCP is configured for SIP Transport. If this is set to “Yes”, phone will validate server against the new certificate list. The default setting is “No”.
Auto-filling Pickup Feature Code	Sets if the phone system will add the configured feature code to retrieve parked calls. If it is set to “Yes”, the “Pickup Feature Code” configured will be automatically prepended on the phone’s dial pad when retrieving the parked call. The default setting is “Yes”.
Pickup Feature Code	Configures the pickup feature code for call park. If “Auto-filling Pickup Feature Code” is set to “Yes”, this pickup feature code will be automatically filled in on the phone’s dial pad when picking up the parked call.

Account – SIP Settings

Account – Codec Settings

Preferred Vocoder	Lists the available and enabled Video codecs for this account. Users can enable the specific video codecs by moving them to the selected box and set them with a priority order from top to bottom. This configuration will be included with the same preference order in the SIP SDP message.
Hide Vocoder	Hide vocoder information on call screen.
Codec Negotiation Priority	Configures the phone to use which codec sequence to negotiate as the callee. When set to “Caller”, the phone negotiates by SDP codec sequence from received SIP Invite; When set to “Callee”, the phone negotiates by audio codec sequence on the phone. The default setting is “Callee”.
Use First Matching Vocoder in 200OK SDP	Configures the phone to use the first matching codec in the 200OK message. The default value is 0.
Enable Audio RED with FEC	Enables FEC for audio calls, default setting is “No”.
iLBC Frame Size	Sets the iLBC (Internet Low Bitrate Codec) frame size if iLBC is used. Users can select it from 20ms or 30ms. The default setting is 30ms.
2 ITU Payload	G726-32 payload type for ITU packing mode. Payload 2 is static and payload dynamic is dynamic.
G726-32 Dynamic PT	Specifies the G726-32 payload type, and the valid range is 96 to 127. The default setting is “126”.
Opus Payload Type	Defines the desired value (96-127) for the payload type of the Opus codec. The default value is

	123.
G.722.1 Rate	Supports 24kbps or 32kbps, please confirm it with your service provider. The default setting is 24kbps.
G.722.1 Payload Type	Defines the payload, the current range is 100-126. Default setting is 104.
DTMF	<p>Specifies the mechanism to transmit DTMF (Dual Tone Multi-Frequency) signals. There are 3 supported modes: in audio, RFC2833, or SIP INFO.</p> <ul style="list-style-type: none"> • In audio, which means DTMF is combined in the audio signal (not very reliable with low-bit-rate codecs); • RFC2833, which means to specify DTMF with RTP packet. Users could know the packet is DTMF in the RTP header as well as the type of DTMF; • SIP INFO, which uses SIP INFO to carry DTMF. The defect of this mode is that it's easily to cause desynchronized of DTMF and media packet if the SIP and RTP messages are required to transmitted respectively. <p>The default setting is "RFC2833".</p>
DTMF Payload Type	Configures the RTP payload type that indicates the transmitted packet contains DTMF digits. The valid range is from 96 to 127. The default value is 101.
SRTP Mode	<p>Sets if the phone system will enable the SRTP (Secured RTP) mode. It can be selected from dropdown list:</p> <p>Disable Enabled but not forced Enabled and forced</p> <p>SRTP uses encryption and authentication to minimize the risk of denial of service. (DoS). If the server allows to use both RTP and SRTP, it should be configured as "Enabled but not forced". Default setting is "Disable".</p>
SRTP Key Length	<p>Configures all the AES (Advanced Encryption Standard) key size within SRTP. It can be selected from dropdown list:</p> <ul style="list-style-type: none"> • AES128&256 bit • AES 128 bit • AES 256 bit <p>If it is set to "AES 128&256 bit", the phone system will provide both AES 128 and 256 cipher suites for SRTP. If set to "AES 128 bit", it only provides 128-bit cipher suite; if set to "AES 256 bit", it only provides 256-bit cipher suite.</p> <p>The default setting is "AES128&256 bit".</p>
Enable SRTP key life time	Defines the SRTP key life time. When this option is set to be enabled, during the SRTP call, the SRTP key will be valid within 231 SIP packets, and phone will renew the SRTP key after this limitation. The default setting is "Yes".
Silence Suppression	Enables the silence suppression/VAD feature. If it is set to "Yes", when silence is detected, a small quantity of VAD packets (instead of audio packets) will be sent during the period of no talking. If set to "No", this feature is disabled. The default setting is "No".
Voice Frames per TX	Configures the number of voice frames transmitted per packet. When configuring this, it should be noted that the "ptime" value for the SDP will change with different configurations here. This value is related to the codec used and the actual frames transmitted during the in-payload call. For end users, it is recommended to use the default setting, as incorrect settings may influence the audio quality. The default setting is 2.
RTCP Destination	<p>Configures the server address. When there is a call, the RTCP package sent from the phone will also be sent to this address.</p> <p>Server Address format must be IP:Port. The port range is 0-65535.</p> <p>Note: The address should contain port number. A prompt message will be displayed if the port number is not specified.</p>

Account – Call Settings

Dial Plan Prefix	Configures the digits prepended to the dialed number.
Disable Dial Plan	<p>Enables/disables the Dialplan mechanism for different cases. If the specific case is checked, the Dialplan mechanism will be disabled.</p> <ul style="list-style-type: none"> ● Dial Page: It controls the pattern of dialing numbers from the keypad, phone app and account widget. ● Contact: It controls the pattern of dialing numbers from local, LDAP and Broadsoft contacts. ● Incoming Call History: It controls the pattern of dialing numbers from inbound call logs. ● Outgoing Call History: It controls the pattern of dialing numbers from outbound call logs. ● MPK&Click2Dial: It controls the pattern of dialing numbers from MPK app and the link on the webpage. <p>The default setting is unchecking all the cases.</p>
Dial Plan	<p>Configures the dial plan to establish the expected number and pattern of digits for a telephone number. This parameter configures the allowed dial-plan for the device.</p> <p>Dial Plan Rules:</p> <ol style="list-style-type: none"> 1. Accepted Digits: 1,2,3,4,5,6,7,8,9,0 , * , #, A,a,B,b,C,c,D,d,+ 2. Grammar: x – any digit from 0-9; <ul style="list-style-type: none"> ● xx+ or xx. – at least 2-digit numbers ● xx – only 2-digit numbers ● ^ – exclude ● [3-5] – any digit of 3, 4, or 5 ● [147] – any digit of 1, 4, or 7 ● <2=011> – replace digit 2 with 011 when dialing ● – the OR operand ● + – add + to the dialing number <p>Example 1: {[369]11 1617xxxxxxx}</p> <p>Allow 311, 611, and 911 or any 10-digit numbers with leading digits 1617</p> <p>Example 2: {^1900x+ <=1617>xxxxxxx}</p> <p>Block any number of leading digits 1900 or add prefix 1617 for any dialed 7-digit numbers.</p> <p>Example 3: {1xxx[2-9]xxxxxx <2=011>x+}</p> <p>Allow any number with leading digit 1 followed by a 3-digit number, followed by any number between 2 and 9, followed by any 7-digit number OR allow any length of numbers with leading digit 2, replacing the 2 with 011 when dialed.</p> 3. Default: Outgoing – { x+ +x+ *x+ *xx*x+ } <p>Allow any number of digits, OR any number with a leading +, OR any number with a leading *, OR any number with a leading * followed by a 2-digit number and a *. To dial + from keypad, press on 0 until + appears on LCD.</p> <p>Example of a simple dial plan used in a Home/Office in the US:</p> <pre>{^1900x. <=1617>[2-9]xxxxxx 1[2-9]xx[2-9]xxxxxx 011[2-9]x. [3469]11 }</pre> <p>Explanation of example rule (reading from left to right):</p> <ul style="list-style-type: none"> ● ^1900x. – prevents dialing any number started with 1900 ● <=1617>[2-9]xxxxxx – allow dialing to local area code (617) numbers by dialing 7 numbers and 1617 area code will be added automatically ● 1[2-9]xx[2-9]xxxxxx - allow dialing to any US/Canada Number with 11 digits' length ● 011[2-9]x. – allow international calls starting with 011 ● [3469]11 – allow dialing special and emergency numbers 311, 411, 611 and 911 <p>The dial plan supports also “T” character which means dial delay. This is used with “No key entry timeout (s)”.</p> <p>For example, if the dialplan is set to {8001T}, when the user opens Phone app and dials 8001, the phone would not call out immediately, but will wait for the No key entry timeout to dial out.</p>

	<p>Note: In some cases, where the user wishes to dial strings such as *123 to activate voice mail or other applications provided by their service provider, the * should be predefined inside the dial plan feature. An example dial plan will be: {*x+} which allows the user to dial * followed by any length of numbers.</p>
Refer-To Use Target Contact	Permits the “Refer-To” header to use the transferred target’s Contact header information for attended transfer. The default setting is “No”.
Auto Answer	It is set if the phone system will allow to answer an incoming call. If it is set to “Yes”, the phone will automatically enable the speaker phone to answer all the incoming calls after a short reminding beep. If set to “Enable Intercom/Paging”, it will automatically answer the incoming calls whose SIP INVITE includes auto-answer tag in the info header. The default setting is “No”.
Intercom Barging	Configures whether to answer the incoming intercom call when there is already an active call on the phone. When “Intercom Barging” is enabled, if the current active call is an intercom call, the incoming intercom call will be automatically rejected; if the current active call is not an intercom call, the current active call will be put on hold and the incoming intercom call will be automatically answered. When “Intercom Barging” is disabled, a prompt will show up indicating the incoming intercom call without interrupting the current active call. The default setting is disabled.
Custom Alert-Info for Auto Answer	Configure the Alert-Info contents. Only when the info or the parameter in Alert-Info header matches this content would the phone answer the paging call automatically. The default setting is blank, which means answer all paging calls automatically.
Send Anonymous	Sets the phone system to make an anonymous outgoing call. If it’s set to “Yes”, the “From” header in the SIP INVITE messages will be set to anonymous, essentially blocking the Caller ID to be displayed. The default setting is “No”.
Reject Anonymous Call	If set to “Yes”, anonymous calls will be rejected. Default setting is “No”.
Call Log	Rejects the calls whose SIP INVITE message includes Anonymous information in from header when enabled. The default setting is “No”.
Special Feature	Configures phone’s settings to meet different vendors’ server requirements. Users can choose from Standard, BroadSoft, CBCOM, RNK, China Mobile, ZTE IMS, Mobotix, ZTE NGN, Huawei IMS.
Feature Key Synchronization	Synchronizes the BroadSoft standard call feature. If it is enabled, the phone will send SIP SUBSCRIBE message to the server and receive SIP NOTIFY message from the server to synchronize the DND, Call Forwarding and Call Center features. The default setting is “Disable”.
Enable Call Features	Enables the local call feature code on the phone to be used. Otherwise, the feature code will need to be provided from the server side. The default setting is “No”.
No Key Entry Timeout (s)	<p>Determines the expiration timer (in seconds) for no key entry. The dialed digit will be send out if no other digits entered within the set period. The default value is 4 seconds.</p> <p>The valid range is from 1 to 15. This feature does not work if the dialer page is entered via the Account Widget on the phone.</p>
Ring Timeout (s)	Defines the expiration timer (in seconds) for the rings with no answer. The default setting is 60. The valid range is from 10 to 300.
Virtual Account Group	Allows to categorize accounts in server mode groups, the accounts in the same group will be combined as one and the account widget will display the Caller ID in the account with lowest ID. The phone can answer any incoming calls to each account in groups. If user makes an outbound call, the phone system will use the lowest ID account by default. If the account fails or SIP INVITE message is timeout, the phone system will failover to the next account in the

	group with higher account ID. If all the accounts are not available in the group, the phone system will traverse all the accounts in the group and notify the end users the session is failed.
Transfer on 3-way Conference Hang up	Transfers conference from hosted party when hang up, thus other parties can continue the conference without interruption. The default setting is unchecked
Use # as Dial Key	Treats “#” as the “Send” (or “Dial”) key. If set to “No”, this “#” key can be included as part of the dialed number (please make sure the dial plan is properly configured to allow dialing # out). The default setting is “Yes”.
DND Call Feature On	Configures the feature code to enable the DND (Do Not Disturb) feature for this account. If it is configured, the phone will dial the feature code automatically when the DND feature is enabled.
DND Call Feature Off	Configures the feature code to disable the DND (Do Not Disturb) feature for this account. If it is configured, the phone will dial the feature code automatically when the DND feature is disabled.
Conference-URI	Configures the network based conference URI (the BroadSoft Standard). If it is configured, end user needs to tap the N-way key during the conference to transfer the host to the remote media server.
Account Ring Tone	Configures the ringtone for the account. Users can set ringtones from the dropdown list. User can also import customized ringtone from LCD Setting menu. The customized ringtone file name will also be showed up in the dropdown list that allows user to select.
Call Forward Mode	<p>Sets the Call Forwarding feature for this account.</p> <ol style="list-style-type: none"> None: Disable call forwarding feature. Unconditional: Set to forward all calls to a specified account. Time based: Set the call forwarding rule based on time. The system can forward the incoming calls to the accounts of “In Time Forward to” and “Out Time Forward to”. Others: Set the call forwarding rule based on account status. The system can forward the incoming calls to the accounts of Busy to, No Answer to, and No Answer Timeout. The valid range for No Answer Timeout (s) is from 1 to 120.
All To	Specifies the number to be forwarded to when “Unconditional” Call Forward Type is used.
Time Period	Configures the period of time to forward the call when “Time based” Call Forward Type is used.
In Time Forward To	When “Time based” Call Forward Type is used, specifies the number to be forwarded to within the configured Time Period above.
Out Time Forward To	When “Time based” Call Forward Type is used, specifies the number to be forwarded to when it’s not within the configured Time Period.
Enable Busy Forward	Enables / disables busy forward feature. Default settings is disabled.
Busy To	Specifies the number to be forwarded to for Call Forward On Busy.
Enable No Answer Forward To	Enables/Disables no answer forward feature. Default settings is disabled.
No Answer To	Specifies the number to be forwarded to for Call Forward On No Answer.
No Answer Timeout (s)	Defines the timeout (in seconds) before the call is forwarded on no answer. The default value is 20 seconds.

<p>Matching Incoming Caller ID</p>	<p>Specifies the rules for the incoming calls. If the incoming caller ID or Alert Info matches the number, pattern or Alert Info text rules, the phone will play the selected distinctive ringtone. The rule policy:</p> <ul style="list-style-type: none"> - Specific caller ID number. For example, 8321123; - A defined pattern with certain length using x and + to specify, where x could be any digit from 0 to 9. Samples: <ul style="list-style-type: none"> • xx+ : at least 2-digit number; • xx : only 2-digit number; • [345]xx: 3-digit number with the leading digit of 3, 4 or 5; • [6-9]xx: 3-digit number with the leading digit from 6 to 9. - Alert Info text: <p>Users could configure the matching rule as certain text (e.g., priority) and select the custom ring tone mapped to it. The custom ring tone will be used if the phone receives SIP INVITE with Alert-Info header in the following format: Alert-Info: <http://127.0.0.1>; info=priority</p>
<p>Distinctive Ring Tone</p>	<p>Selects the distinctive ring tone for the matching rule. When the incoming caller ID or Alert Info matches the rule, the phone will ring with the selected ring.</p>
<p>Upload Local MOH Audio File</p>	<p>Loads the MOH (Music on Hold) file to the phone. Click on “Browse” button to upload the music file from local PC. The MOH audio file has to be in .wav or .mp3 format.</p> <p>Note: Please be patient while the audio file is being uploaded. It could take more than 3 minutes to finish the uploading especially the file size is large.</p> <p>The button will show as “Processing” during the uploading. Once done, it will show as “Browse” again. Click on “Save” on the bottom of the web page and “Apply” on the top of the web page to save the change.</p>
<p>Enable Local MOH</p>	<p>Plays local MOH file if the call is being hold by the phone. The default setting is “No”.</p>

Account – Call Settings

Advanced Settings Page Definitions

Advanced Settings page lists General Settings, Call Features, Tone Generator, Multicast Paging, MPK General Settings and MPK LCD Settings.

Advanced Settings – General Settings

Advanced page lists General Settings, Call feature, Tone settings and call features.

<p>Local RTP Port</p>	<p>Defines the local RTP-RTCP port pair used to listen and transmit.</p> <p>If it is configured with X, in channel 0 the port X will be used for audio RTP message, the port X+1 for audio RTCP message, the port X+2 for video RTP message and the port X+3 for video RTCP. In Channel 1, each port number will be incremented by 4 for each message. This increment rule will apply to other channels and other port numbers.</p> <p>By default, the Account 1 will use Channel 0, Account 2 Channel 1, Account 3 Channel 2, Account 4 Channel 3, and Account 5 Channel 4 and Account 6 Channel 5.</p> <p>If an account needs to establish multiple session simultaneously, the system will use the ports in the next available channels.</p> <p>The default value is 5004. The valid range is from 1024 to 65400.</p>
<p>Use Random Port</p>	<p>Forces the phone system to use random ports for both SIP and RTP messages. This is usually necessary when multiple phones are behind the same full cone NAT. The default setting is “No”.</p> <p>Note: This parameter must be set to “No” for Direct IP Calling to work.</p>
<p>Disable in-call DTMF display</p>	<p>Enables/disables the phone system to omit the LDAP contacts will from LCD screen. If it is</p>

	enabled, end user is not allowed to use it in the Contact app. The default setting is “No”.
Enable Enterprise Contacts Timeout Auto Search	Configures whether to display the matched content automatically in search of the LDAP Contacts when timeout. If set to “No”, users need to click the Search button to search the matched contacts mentioned above. The default is “Yes”.
Hide LDAP Contacts	Enables/disables the phone system to omit the LDAP contacts will from LCD screen. If it is enabled, end user is not allowed to use it in the Contact app. The default setting is “No”.
Keep-alive Interval (s)	Specifies how the phone system will send a Binding Request packet to the SIP server in order to keep the “ping hole” on the NAT router to open. The default setting is 20 seconds. The valid range is from 10 to 160.
STUN Server	Configures the URI of STUN (Simple Traversal of UDP for NAT) server. The phone system will send STUN Binding Request packet to the STUN server to learn the public IP address of its network. Only non-symmetric NAT routers work with STUN. Default setting is “stun.ipvideotalk.com”.
Use NAT IP	Configures the IP address for the Contact header and Connection Information in the SIP/SDP message. It should ONLY be used if it’s required by your ITSP. The default setting is keep the box blank
Permission to Install/Uninstall Apps	Configures the permissions for users to install/uninstall the applications. If set to “Allow”, the user is free to install/uninstall third-party apps; If set to “Require admin password”, the user need to input the correct administrator password to install/uninstall third-party apps; If set to “Require admin password if the app source is unknown”, the user need to input admin password only when install apps from unknown source, administrator password authentication is required when the user uninstall third-party apps. The default setting is “Allow”.
Guest Login	Enables the Desking mode. End users need to configure the SIP domain name before implementing this feature. Users also should enter SIP username and password manually on LCD after reboot the phone. The default setting is “No”.
Guest Login Timeout (m)	Configures the timeout to quit the hot Desking mode if there are not any operations on the phone. The default setting is “Never”.
Guest Login PIN Code	Defines PIN code for guest login. If the hot Desking mode is enabled and the guest login timeout set to Never, it needs end user to enter the PIN code to login. The default setting is NULL. Note: The guest Login Pin Code can only contain letters and digits. Otherwise, an error message will show up once you click on SAVE.
SIP Domain	Configures the SIP domain under Avaya mode. Fill in the SIP server address, in order to choose the registered server before login Avaya server. This function should be used with Outbound Proxy option under Account→Network Settings.
Fixed Slave Mode	Configures whether the GAC device always in slave mode or not. If checked, the GAC can be used as audio auxiliary device only, if not checked, then the GAC will be used as audio auxiliary device only when its Micro-USB data interface is connected to the master device such as GVC device or PC, when the master device is disconnected from the GAC, the GAC can restore independent audio conference function. The default setting is “No”

Advanced – General Settings

Advanced Settings – Call Features

Virtual Account Group Avaya Mode	Once enabled, the GAC will register the first two accounts in virtual account group, if the two accounts registration fails, then it will register other accounts. If disabled, then use common
-----------------------------------------	-------------------------------------------------------------------------------------------------------------------------------------------------------------------------------------------------

	virtual account group mode. The default setting is “No”.
Disable Call-Waiting	Disables the call waiting feature. If it is checked, the phone system will reject the second incoming call during an active session without user’s knowledge. But this missed call record will be saved to remind users. The default setting is “No”.
Display Soft Keyboard	Enables the QWERTY soft keyboard in the phone app/dialer page. If it is set to “Yes”, the soft keyboard will pop up by tapping the input box. Default setting is “No”. It is recommended to disable the dial plan of the dial page on the Account Settings page, or the call may fail if dial characters are not conforming to the dial plan.
Filter Characters	Sets the characters for filter when dial out numbers. Users could set up multiple characters. For example, if set to “[()-]”, when dial (0571)-8800-8888, the character “()-” will be automatically filtered and dial 057188008888 directly.
Disable Call-Waiting Tone	Sets the phone system to play the call waiting tone if there is another incoming call. If it is set to “Yes”, the phone will only display the indicator on the LCD screen for another incoming call. The default setting is “No”.
Disable DND Reminder Ring	Configures the phone system will play the DND reminder ringtone for the incoming call if the DND feature is enabled. If it set to “Yes”, the phone will keep mute instead of playing a ring splash to indicate an incoming call when DND is enabled. The default setting is “No”.
Disable Direct IP Call	Configures the phone system to allows the end users to make an outbound IP call. If it is set to “Yes”, the phone will hide the IP call feature and end users will not be allowed to make an outbound IP call. The default setting is “No”.
Use Quick IP-Call Mode	Sets the phone system to automatically fills in the first three octets to make an outbound IP call. If it is set to “Yes”, users can dial an IP address under the same LAN/VPN segment by entering the last octet in the IP address. To dial quick IP call, off-hook the phone and dial #XXX (X is 0-9 and XXX <=255), the phone will make direct IP call to aaa.bbb.ccc.XXX where aaa.bbb.ccc comes from the local IP address REGARDLESS of subnet mask. #XX or #X are also valid so leading 0 is not required (but OK). No SIP server is required to make quick IP call. The default setting is “No”.
Disable Transfer	Disables the transfer feature. When set to “Yes”, the phone system will block the TRANSFER key on the LCD screen. The default setting is “No”.
Default Transfer Mode	Sets the default transfer mode for the phone system. If the Blind Transfer or Attended Transfer mode is set, the phone system will use the specific mode to transfer an active call. The users still have privilege to switch the mode on the LCD screen when they tap the transfer key. The default setting is “Blind Transfer”.
Escape ‘#’ as %23 in SIP URI	Determines which characters will be included in the SIP INVITE URI if end users input #. If it is set to “Yes”, the phone system will replace the # by %23. Otherwise, it will include # in the SIP INVITE message. The default setting is “Yes”
Voice Mode	Configures sound balance in call. “ Large room ” has 10m*10m indoor space, “ Medium room ” has 7m*7m indoor space “ Small room ” has 3m*3m indoor space. “ Rich voices ” focuses on low and medium frequency and sounds deep to human ears. “ Clear voices ” focuses on medium and high frequency and it sounds bright to human ears.

	<p>The degree of “Small room & Denoise” is 18db.</p> <p>The degree of “Small room & Enhance Denoise” is 24db.</p> <p>The default setting is “Large room & Clear”.</p>
Conference Server	Enables this function to access conference mode, all lines will be in conference room and single line operation is prohibited. The default setting is ”No“.
Enable Conference Room Quite Mode	Configures whether to enable voice prompt when conference members enter or exit the conference. Once enabled, when a member enters or exits the conference, members online can hear the corresponding voice prompt. The default is “No”
Record Mode	Selects recording mode location; locally or on server.
Auto Mute on Entry	<p>Configures whether to mute the call on entry automatically.</p> <p>“Disable” means that the feature is not used.</p> <p>“Auto Mute on Outgoing Call” will mute automatically when the other party answers the outgoing call.</p> <p>“Auto Mute on Incoming Call” will mute automatically when answers the incoming call.</p> <p>“Mute on Incoming & Outgoing Call” will mute automatically when the call gets through. Users could click the Mute button on call interface to cancel the current mute status. The default setting is “Disable”.</p>
Ignore early media in conference	Once enabled, the device would not play early media in an outgoing call in conference. P-value is 22222. Default is No – 0.

Advanced – Call Features

Advanced Settings – Tone Generator

Auto Config CPT by Region	If set to “Yes”, GAC2500 will configure CPT (Call Progress Tone) according to different regions automatically. If set to “No”, you can configure CPT parameters manually. The default setting is “No”.
Call Progress Tones: <ul style="list-style-type: none"> • Dial Tone • Ring Back Tone • Busy Tone • Reorder Tone • Confirmation Tone • Call-Waiting Tone • PSTN Disconnect Tone 	<p>Configures tone frequencies according to user preference. By default, the tones are set to North American frequencies. Frequencies should be configured with known values to avoid uncomfortable high pitch sounds. Syntax: f1=val,f2=val [,c=on1/off1[-on2/off2[-on3/off3]]]; (Frequencies are in Hz and cadence on and off are in 10ms) ON is the period of ringing (“On time” in “ms”) while OFF is the period of silence. In order to set a continuous ring, OFF should be zero.</p> <p>Otherwise it will ring ON ms and a pause of OFF ms and then repeats the pattern. Please refer to the document below to determine your local call progress tones: http://www.itu.int/ITU-T/inr/forms/files/tones-0203.pdf</p>
Call-Waiting Tone Gain	By default, tones are set to the North American standard. Users could adjust the tone frequencies based on parameters from the local telecom provider. Users could select “Low”, “Medium” or “High”. The default setting is “Low”.
Ring Cadence	Defines the ring cadence for the phone. The default setting is: c=2000/4000

Advanced – Tone Generator Settings

Advanced Settings – Multicast Paging

This page will show only if Expert mode is enabled.

Paging Barge	Sets the threshold of paging calls. If the paging call's priority is higher than the threshold, the existing call will be hold and the paging call will be answered. Otherwise, the existing call does not be affected. If it is set to Disable, any paging call will not be answered. The default setting is "Disable".	
Paging Priority Active	Determines if a new paging call whose priority is higher than the existing paging call will be answered. If it is checked, this feature will be enabled. The default setting is disabled.	
Multicast Paging Codec	Selects the codec type for the multicast paging call. This list includes PCMU, PCMA, G726-32, G722, and G729A/B.	
Multicast Listening	Priority	Determines if a new paging call whose priority is higher than the existing paging call will be answered. If it is checked, this feature will be enabled. The default setting is disabled
	Listening Address	Configures the IP address and port number (valid port range is 1- 65535) for monitoring multicast paging call. When the initiator initiates a call, answer the call and display listening address and tag of the monitoring target. This feature supports Video Multicast, when the initiator initiates Video Multicast, it will automatically add the number 2 on the port of the listening address. Reboot the phone to make changes take effect. The valid IP address ranges from 224.0.0.0 to 239.255.255.255. Users may also fill the label for each listening address corresponding to the priority.
	Label	Defines the label for each listening address corresponding to the priority.

Multicast Paging

Advanced Settings – MPK General Settings

BLF Call-pick Prefix	Configures the prefix prepended to the BLF extension when the phone picks up a call with BLF key. The default setting is ** for each account.
Event List URI	Configures the event list BLF URI on the phone to monitor the extensions in the list with multi-purpose keys. The server side has to support this feature. Users need to configure an event list BLF URI on the service side first (i.e., BLF1006@myserver.com) with a list of extensions included. On the phone, in this "event list BLF URI" field, fill in the URI without the domain (i.e., BLF1006).
Force BLF Call-pickup by Prefix	Uses the prefix for BLF Call-pickup. The default setting is "No".

Advanced – MPK General Settings

Advanced – MPK LCD Settings

BLF List	Displays the configured MPK keys. Users could change the keys order by selecting "Up", "Down", "Check All", or "Delete"
Key Mode	Assigns a function to the Multi-Purpose Key in the MPK app The key mode options are:

	<p>Speed Dial Press to dial the extension configured in UserID field.</p> <p>Busy Lamp Field (BLF) Monitor the extension status as configured in UserID field.</p> <p>Call Transfer Transfer the current active call to the extension configured in UserID field.</p> <p>Call Intercom Intercom/paging to the extension configured in UserID field.</p> <p>Speed Dial via Active Account Similar to Speed Dial but it will dial based on the current active account. For example, if the phone is off-hook and account 2 is active, it will call the configured extension using account 2.</p> <p>Dial DTMF Dial the DTMF digits filled in UserID field during a call.</p> <p>Call Park Configure the call park feature code to park or pick up the call.</p> <p>Multicast Paging Configure the IP address and port for establish a multicast paging call.</p> <p>Group Call Set up to 6 numbers for an account to start a conference. Users need to add the member numbers into a list.</p>
Account	Selects the SIP Account used for the multi-purpose keys.
Name	Configures the display name for the multi-purpose key.
User ID	Configures the User ID for the corresponding multi-purpose key mode.
Display Format	Configures the display format for the multi-purpose keys. Users could select display "Name", "UserID", or "UserID(Name)". The "Name" is the name saved in GAC2500 Contacts. The default setting is "Name".
Show Display Name from Server	If check, the name on server will replace the one user configured before. The default setting is "No".

Advanced – MPK LCD Settings

Maintenance Page Definitions

Maintenance page lists Network Settings, Time & Language, Security Settings, Upgrade, troubleshooting and MPK Settings.

Maintenance – Network Settings

Preferred Internet Protocol	<p>Selects one of the following IP protocol modes:</p> <p>IPv4 Only: Enforce IPv4 protocol only.</p> <p>IPv6 Only: Enforce IPv6 protocol only.</p> <p>Both, Prefer IPv4: Enable both IPv4 and IPv6 and prefer IPv4.</p> <p>Both, prefer IPv6: Enable both IPv4 and IPv6 and prefer IPv6.</p> <p>Note: Make sure to reboot the phone for the changes to take effect.</p>
Address Type	Allows users to configure the appropriate network settings on the phone. Users could select "DHCP", "Static IP" or "PPPoE".
DHCP VLAN Override	<p>When set to "DHCP Option 132 and DHCP option 133", the phone will get DHCP option 132 and 133 as VLAN ID and VLAN priority. When set to "Encapsulated in DHCP Option 43", the phone will get values from Option 43 which encapsulate VLAN ID and VLAN priority.</p> <p>Notes:</p>

	Please make sure the “Allow DHCP Option 43 and Option 66 to Override Server” setting under maintenance→upgrade is checked. The default setting is “Encapsulated in DHCP Option 43”. Provision fails over to config server path when the device fails to provision from DHCP
Host name (Option 12)	Option. Specifies the name of the client. This field is optional but may be required by some Internet Service Providers.
Vendor Class ID (Option 60)	Used by clients and servers to exchange vendor class ID.
IP Address	Enter the IP address when static IP is used.
Subnet Mask	Enter the Subnet Mask when static IP is used.
Default Gateway	Enter the Default Gateway when static IP is used.
DNS Server 1	Enter the DNS Server 1 address when static IP is used.
DNS Server 2	Enter the DNS Server 2 address when static IP is used.
PPPoE Account ID	Enter the PPPoE account ID.
PPPoE Password	Enter the PPPoE Password.
Alternate DNS Server	Configures alternate DNS server.
Second Alternate DNS Server	Configures secondary alternate DNS server.
Enable LLDP	Enable / Disable LLDP.
LLDP TX Interval(s)	Configures the interval the phone sends LLDP-MED packet, the default setting is 30s.
Layer 3 QoS for SIP	Defines the Layer 3 QoS parameter for SIP packets. This value is used for IP Precedence, Diff-Serv or MPLS. Default value is 26.
Layer 3 QoS for Audio	Defines the Layer 3 QoS parameter for Audio packets. This value is used for IP Precedence, Diff-Serv or MPLS. Default value is 46.
Layer 2 QoS 802.1Q/VLAN Tag (Ethernet)	Assigns the VLAN Tag of the Layer 2 QoS packets for LAN port. The default value is 0. Note: Please do not change the setting before understanding the VLAN’s settings, or the phone can’t get the correct IP address.
Layer 2 QoS 802.1p Priority Value (Ethernet)	Assigns the priority value of the Layer2 QoS packets for LAN port. The default value is 0.
Layer 2 QoS 802.1Q/VLAN Tag (Wi-Fi)	Assigns the VLAN Tag of the Layer 2 QoS packets for Wi-Fi. The default value is 0. Note: Please do not change the setting before understanding the VLAN’s settings, or the phone can’t get the correct IP address.
Layer 2 QoS 802.1p Priority Value (Wi-Fi)	Assigns the priority value of the Layer2 QoS packets for Wi-Fi. The default value is 0.
HTTP/HTTPS User-Agent	This sets the user-agent for phonebook and screen saver
SIP User-Agent	Sets the user-agent for SIP.
802.1x mode	Enables and selects the 802.1x mode for the phone system. The supported 802.1x modes are: EAP-MD5

	EAP-TLS EAP-PEAP The default setting is “Disable”.
802.1x Identity	Enters the identity information for the selected 802.1x mode. (This setting will be displayed only if 802.1 X mode is enabled).
802.1x Secret	Enters the secret for the 802.1x mode. This option will be appeared when 802.1x mode is EAP-MD5 or EAP-PEAP.
CA Certificate	Uploads the CA Certificate file to the phone. (This setting will be displayed only if the 802.1 X mode is enabled)
Client Certificate	Loads the Client Certificate file to the phone. (This setting will be displayed only if the 802.1 X TLS mode is enabled)
Private Key	Loads the private key file to the phone. (This setting will be displayed only if the 802.1 X TLS mode is enabled)
HTTP/HTTPS Proxy Hostname	Specifies the HTTP/HTTPS proxy hostname for the phone to send packets to.
HTTP/HTTPS Proxy Port	Specifies the HTTP/HTTPS proxy port.
Bypass Proxy For	Defines the list of destination IP addresses where no proxy server is needed. Multiple IP addresses can be separated by “,”.
IPv6 address	Select either Statically configured or Auto configured address.
Static IPv6 address	Set the Static IPv6 address.
IPv6 prefix length	Enter the IPv6 prefix length, default value is 64.
DNS server 1	Enter DNS server 1 when static IPv6 is used.
DNS server 2	Enter DNS server 2 when static IPv6 is used.
Preferred DNS Server	Enter the preferred DNS server when static IPv6 is used.

Maintenance – Network Settings

Maintenance – Wi-Fi Settings

Wi-Fi Basics	
Wi-Fi Function	Enables/disables the Wi-Fi function. The default setting is set to “No”.
ESSID	Permits to scan and select the available Wi-Fi networks within the range if the WiFi feature is enabled. Press “Scan” to scan for the available wireless network. The number in brackets represents the signal intensity.
Wi-Fi Security	
ESSID	Display the selected ESSID name.
Password	Configures the selected ESSID password.

Security Mode for Hidden SSID	Defines the security mode used for the wireless network when the SSID is hidden.
--------------------------------------	----------------------------------------------------------------------------------

Wi-Fi Settings

Maintenance – Time & Language

Specify NTP Server Address	Defines the URL or IP address of the NTP server. The phone may obtain the current date and time information from the server. The default setting is “pool.ntp.org”.
DHCP Option 42 override NTP server	Defines whether DHCP Option 42 should override NTP server or not. When enabled, DHCP Option 42 will override the NTP server if it’s set up on the LAN. The default setting is “Yes”.
DHCP Option 2 to override Time Zone setting	Allows device to get provisioned for Time Zone from DHCP Option 2 in the local server automatically. If it set to “Yes”, the DHCP offer with Option 2 will override the phone system’s time zone setting. The default setting is “No”.
Time Zone	Specifies the local time zone for the phone. It covers the global time zones and user can select the specific one from the drop-down list.
Use 24-hour format	Use 24-hour time display format.
Date Display Format	Configures the date display format on the LCD. The following formats are supported: Normal (M/DD/YYYY): 1/31/2012 YYYY/MM/DD: 2012/01/31 MM/DD/YYYY: 01/31/2012 DD/MM/YYYY: 31/01/2012 The default setting is DD/MM/YYYY.
Language	Configures the language on device.

Maintenance – Time & Language

Maintenance – Security Settings

Emergency Call Numbers	Configures emergency call numbers.
Disable SSH	Blocks any SSH access to the phone. The default setting is “No”.
Disable web GUI	If set to “Yes”, the GAC will not allow any web access to it. The default value is “No”.
Access Method	Determines which protocol will be used to access the phone ‘s Web GUI. It can be selected from HTTP and HTTPS. The default setting is HTTP.
Port	Specifies which port to use to access the phone ‘s Web UI. By default, if HTTP, the port number will be 80; if HTTPS is selected, the port number will be 443.
Admin Password	Configures the administrator password for Web GUI. It is case sensitive with a maximum length of 32 characters. Default password is “admin”.
Confirm Admin Password	Confirms the new admin password.
User Password	Configures the user password for Web GUI. It is case sensitive with a maximum length of 32

	characters. The default password is “123”.
Confirm User Password	Confirms the new admin password.
User Authority Management	If not checked, then use the system default user authority configuration; If checked, you can click on the “Configure Permission” button to select authority. The default setting is “No”.
Configuration via Keypad Menu	<p>Configures access control for keypad Menu settings on the Settings interface of the phone.</p> <ul style="list-style-type: none"> • Unrestricted: configure all settings on the Settings interface; • Basic Settings Only: The Advanced Settings option will not be displayed; • Constraint Mode: users need to input admin user password to configure Wireless & Network and Advanced Settings. <p>Warning: If the admin password is lost while constraint mode is enabled, your device may become permanently unusable. Remember to be careful when using constraint mode to avoid irreversible damage.</p> <p>Note: When access control for keypad is limited to “Basic Settings Only” or “Constraint Mode”, the Admin authentication will be mandatory to start Factory Reset process.</p>
SIP TLS Certificate	Defines the SSL private key used for SIP over TLS. The SSL private key the user specified for TLS encryption should be X.509 format.
SIP TLS Private Key	Defines the SSL private key used for SIP over TLS. The SSL private key the user specified for TLS encryption should be X.509 format.
SIP TLS Private Key Password	Defines the SSL private key password used for SIP over TLS.
Custom Certificate	This feature allows user to upload custom certificate. The priority of certificate is SIP TLS/Certificate/Private Key (Only SIP TLS used) > Custom Certificate > Individual Certificate > General Certificate.
Import Custom Certificate	Uploads certificate file from PC using BROWSE button. The certificate file should be “.pem”, “.crt”, and “.cer” or “.der” format. The Browse button will turn to “Processing” and back to “Browse” once the uploading finished. Note: Users can also delete uploaded custom certificate by clicking on “Delete”.
Import Trusted CA Certificates	Clicks the Browse to upload certificate file from PC. The certificate file should be “.pem”, “.crt”, “.cer”, or “.der” format. The Browse button will turn to “Processing” and back to “Browse” once the upload finished.

Maintenance – Security Settings

Maintenance – Upgrade

Always send HTTP Basic Authentication Information	<p>This setting is to enable/disable send HTTP basic authentication feature when the phone user wget package to download “cfg.xml” file. If set to “Yes”, the phone will always send HTTP with credentials. Otherwise, the phone only sends the HTTP with credentials only when the server requests.</p> <p>The default is setting is “No”.</p>
Validate Certificate Chain	Configures whether validate server certificate. If check, the phone will download firmware/config file from legal server. Default is setting is No.
mDNS Override Server	If set to “Use Type A” or “Use Type SRV, allows mDNS override config/firmware server setting on the phone if present. The default setting is “User Type A”.
Allow DHCP Option 43 and Option 66 to Override Server	It is used to set if the phone system allows the DHCP offer message to override the Config Server Path via the Option 66 header. The phone system supports both TFTP and HTTP method

	via Option 66. The default setting is “Yes”.
DHCP Option 120 Override SIP Server	Override the Config Server Path via the Option 120 header. The default setting is “Yes”.
Firmware Upgrade Via	Allows users to choose the firmware upgrade method: TFTP, HTTP, HTTPS or Manual Upload. The default setting is “HTTP”.
Firmware Server Path	Sets IP address or domain name of firmware server. The URL of the server that hosts the firmware release. Default is fm.grandstream.com/gs.
Firmware HTTP/HTTPS User Name	Enters the user name for the firmware HTTP/HTTPS server.
Firmware HTTP/HTTPS Password	Enters the password for the firmware HTTP/HTTPS server.
Firmware File Prefix	This feature allows ITSP to load the firmware with specific prefix to the phone. Only the firmware with the matching encrypted prefix/postfix will be downloaded and flashed into the phone. This setting is for ITSP to configure.
Firmware File Postfix	This feature allows ITSP to load the firmware with specific postfix to the phone. Only the firmware with the matching encrypted prefix/postfix will be downloaded and flashed into the phone. This setting is for ITSP to configure.
Use Grandstream GAPS	When checked GAPS server will be used for provisioning redirection.
Config file Upgrade Via	Selects provisioning method: TFTP, HTTP or HTTPS. Default setting is “HTTPS”.
Config Server Path	Sets IP address or domain name of configuration server. The server hosts a copy of the configuration file to be installed on the GAC2500. Default is fm.grandstream.com/gs.
Config File HTTP/HTTPS User Name	If your HTTP/HTTPS config server has enabled user authentication mode, please fill in user name for authentication.
Config File HTTP/HTTPS Password	If your HTTP/HTTPS config server has enabled user authentication mode, please fill in password for authentication.
Config File Prefix	Checks if configuration files are with matching prefix before downloading them. This field enables user to store different configuration files in one directory on the provisioning server.
Config File Postfix	Checks if configuration files are with matching postfix before downloading them. This field enables user to store different configuration files in one directory on the provisioning server.
XML Config File Password	Decrypts XML configuration file when encrypted. The password used for encrypting the XML configuration file is using OpenSSL.
Authenticate Conf File	Sets the phone system to authenticate the configuration file before applying it. If it set to “Yes”, the configuration file must include value P1 with phone system’s administration password. If it is missed or does not match the password, the phone system will not apply it. The default setting is “No”
Download Device Configuration	Click to download the device configuration file to PC.
Upload Device Configuration	Click to upload the configuration file on PC to device.
Cust File Upgrade Via	Selects download method: TFTP, HTTP or HTTPS. Default is “HTTP”.

Cust Config Server Path	Sets IP address or domain name of the GUI customization file server. The server hosts a copy of the file to be installed on the phone. The Default setting is fm.grandstream.com/gc.
Cust File HTTP/HTTPS User Name	Enters the username for the firmware HTTP/HTTPS server.
Cust File HTTP/HTTPS Password	Enters the password for the firmware HTTP/HTTPS server.
Use Configurations of Config File Server	Retrieve and download customization file with the configuration of the config file.
Enable PNP Feature	Enables the PNP (Plug and Play) feature on the device. If it is enabled, the device will be set as a provision server to send SIP NOTIFY message including the provision URL to response the client phone's SIP SUBSCRIBE request. This feature will be enabled if the PNP URL is configured. If this setting is enabled, the 3CX Auto provision will be disabled automatically.
PNP URL	Configures the URL to provision another client phone's config server path. The URL will be included in the SIP NOTIFY message.
PNP(3CX) Auto Provision	Sets the phone system to broadcast the SIP SUBSCRIBE message during booting up to allow itself to be discovered and be configured by the SIP platform. The default setting is "Yes".
Automatic Upgrade	It is used to set if and how often the phone system will check the server for new firmware and configuration file downloading. It can be selected from following options: (The default setting is "No") "No" "Check Every Day" "Check Every Week" "Check at a period of time"
Enable Randomized Automatic Upgrade	If set to "Yes", the phone will trigger the upgrade process automatically at a random time point within the time window configured without manual trigger.
Hour of the Day (0-23)	Defines at which hour of the day they phone system will check the HTTP/HTTPS/TFTP server for firmware upgrades or configuration files changes.
Day of the Week (0-6)	Defines which day of the week the phone system will check the HTTP/HTTPS/TFTP server for firmware upgrades or configuration files changes
Automatic Upgrade Check Interval (m)	Configures how the phone system will check the server for new firmware and configuration file downloading. It only valid if the user selects "Check at a period of time" in the "Automatic Upgrade". The default setting is 10080 (namely 7 days).
Firmware Upgrade and Provisioning	Defines the rules for automatic upgrade and configuration file: Always Check at boot up, when Firmware prefix/suffix changes, Skip the Firmware Check.
Disable SIP NOTIFY Authentication	Device will not challenge NOTIFY with 401 when set to "Yes".
Auto Reboot to Upgrade Without Prompt	If set to "Yes", the phone will automatically start upgrading after downloading the firmware files. Otherwise, users would need confirm in the prompted message in LCD to start upgrading process. The default value is "Yes".
Factory Reset	It is used to reset the phone system to the default factory setting mode. If the "Clear the SD card" is checked, the SD card storage mounted to the phone will be format as well.

Maintenance – Upgrade

Maintenance – Recording

Call	Rename, download, and delete the recording that is saved in a call or a conference.
Normal	Rename, download, and delete the recording that is saved in Recorder app.

Maintenance – Recording

Recording. The recording page lists the recordings from calls and normal recording. For each record, users can rename, download, lock, and delete it. If the recording is locked, it cannot be deleted. Or users can batch delete the recordings by checking multiple records and delete them.

Maintenance – Troubleshooting

Syslog	
Syslog Protocol	Choose whether to send syslog messages over UDP or secured SSL/TLS connection to Syslog Server. Default is UDP. Notes: User can upload the CA file under Maintenance → Security settings. A reboot is required in order for the changes to take effect.
Syslog Server Address	Configures the URI, IPv4 or IPv6 which the phone system will send the syslog messages to. The default setting is “log.ipvideotalk.com”. Note: The address Max Length is 128 characters.
Syslog Level	Selects the level of logging for syslog. The default setting is “None”. There are 4 levels from the dropdown list: DEBUG, INFO, WARNING and ERROR. The following information will be included in the syslog packet: DEBUG (Sent or received SIP message,) INFO (Product model/version on boot up, NAT related info, SIP message summary, Inbound and outbound calls, Registration status change, negotiated codec, Ethernet link up) WARNING (SLIC chip exception) ERROR (SLIC chip exception, Memory exception)
Send SIP Log	Configures whether the SIP log will be included in the syslog messages. The default setting is “No”.
Syslog keyword filter	Configures syslog message to be filtered based on keywords provided. If multiple keywords are filled, it should be separated by “,”. Note: No spaces allowed.
Logcat	
Clear Log	Clears the log files saved in the phone system.
Log Tag	Configures the filter to display the specified process log file.
Log Priority	Selects the log priority to display. It can be selected from list below: Verbose (Default Setting) Debug Info Warn Error Fatal Silent (suppress all output)

Debug	
One-Click Debugging	
One-click Debugging	Capture the checked info in the debugging list, click “Start” to debug if including “Capture trace” item and click “Stop” to end. If “Capture Trace” is not checked “Start” button will change to “Capture”. All retrieved files will be generated to a package, and the last package will be overwritten, while the trace file will remain.
Debug Info Menu	Display a list of info items that can be debugged, currently supports Syslog, Logcat and Capture trace. The captured data can be viewed in “Debug information list”. The default is all selected.
Debug Info List	You can select the existing debugging info package or grab package. Click the “Delete” button on the right to delete the file.
View Debug Info	You can select the existing debugging info package or grab package. Click the “Delete” button on the right to delete the file.
Record	
Record	Click to start capturing audio data, click the “Stop” button to end. To capture the audio data of the device can help to locate audio issues. The default is not enabled. You can record up to 1-minute audio data.
Recording List	Choose the existing audio file. Click the “Delete” button on the right to delete this file.
View Recording	Click on the “List” button to view. The captured audio data will be sorted by time. Click to download the data to the computer for analysis.
Core Dump	
Enable Core Dump Generation	Configures whether to generate and save the core dump file when the program crashes. The default setting is “No”. This feature requires a reboot to take effect.
Core Dump List	Selects the existing core dump file in the drop-down box. Users could delete the file by pressing on “Delete” button.
View Core Dump	Press “List” button to view all existing core dump files. The files are listed in chronological order, users could click the file name to download it to local computer.
Traceroute	
Target Host	Input the domain name or IP address and click “Start to show trout tracing result in page below.

Maintenance – Troubleshooting

Maintenance – Event Notify

All Functions	<p>Set URL for specified event, send URL to the configured server when the event occurs on the device, the dynamic variables in which will be replaced with corresponding parameters to realize event notification purpose.</p> <p>Grammatical information:</p> <ul style="list-style-type: none"> ● The P address of SIP server that receive events should be at the front, with “/” to separate dynamic variables. ● “\$” should be added in front of dynamic variables. e.g.
----------------------	---------------------------------------------------------------------------------------------------------------------------------------------------------------------------------------------------------------------------------------------------------------------------------------------------------------------------------------------------------------------------------------------------------------------------------------------------------------------------------------------------------

	<p>local=\$local call-id=\$call-id</p> <ul style="list-style-type: none"> • Connect dynamic variables with “&”. E.g. 192.168.40.207/mac=\$mac&local=\$local, when event occurs, the device will send to server whose address is 192.168.40.207 its MAC address and device number.
--	------------------------------------------------------------------------------------------------------------------------------------------------------------------------------------------------------------------------------------------------------------------------------------------------------------------

Maintenance – TR-069

Enable TR-069	Sets the phone system to enable the “CPE WAN Management Protocol” (TR-069). The default setting is “No”.
ACS URL	Specifies URL of TR-069 ACS (e.g., http://acs.mycompany.com), or IP address
ACS Username	Enters username to authenticate to ACS.
ACS Password	Enters password to authenticate to ACS.
Enable Periodic Inform	Sends periodic inform packets to ACS. Default is “No”.
Periodic Inform Interval (s)	Configures to sends periodic “Inform” packets to ACS based on specified interval.
Connection Request Username	Enters user name for the ACS to connect to the phone
Connection Request Password	Enters password for the ACS to connect to the phone.
Connection Request Port	Enters the port for the ACS to connect to the phone.
CPE Cert File	Uploads Cert File for the phone to connect to the ACS via SSL.
CPE Cert Key	Uploads Cert Key for the phone to connect to the ACS via SSL.

Maintenance – Device Manager

Disable Missed Call Backlight	Keeps LCD screen turned on after screen timeout when there is unchecked missed call on the phone if set to “Yes”. Default is “No”.
Ringling Indicator	Configures the LED indicator status when incoming call rings.
Calling Indicator	Configures the LED indicator status during the call.
Mute Indicator	Configures the LED indicator status when the call or conference host are muted.
Holding Indicator	Configures the LED indicator status when the current call is on hold.
Unread Application Messages Indicator	Configures the LED indicator status when there exists unread message.
System Messages Indicator	Configures the LED indicator status when there exists system message.
Screen Off Indicator	Configures the LED indicator status when the screen is off.

Status Page Definitions

Status page lists Account Status, Network Status, System Info and Storage Info.

Status – Account

Account	All the SIP accounts on the phone. Each account will show its status in this page.
Number	SIP User ID for the account.
SIP Server	URL or IP address, and port of the SIP server.
Status	Registration status for the SIP account.

Status – Account

Status – Network

MAC Address	Global unique ID of device, in HEX format. The MAC address will be used for provisioning and can be found on the label coming with original box and on the label located on the back of the device.
NAT Type	The type of NAT connection used by the phone.
IPv4	
Address Type	The configured address type: DHCP, Static IP or PPPoE.
IPv4 Address	IP address of the phone.
Subnet Mask	Subnet mask of the phone.
Gateway	Default gateway of the phone.
DNS Server 1	DNS Server 1 of the phone.
DNS Server 2	DNS Server 2 of the phone.
IPv6	
IPv6 Address Type	The configured address type: DHCP, Static IP.
IPv6 Address	IPv6 address of the device.
IPv6 DNS Server 1	IPv6 DNS Server 1 of the device.
IPv6 DNS Server 2	IPv6 DNS Server 2 of the device.

Status – Network

Status – System Info

Product Model	Product model of the phone.
Hardware Revision	Hardware version number.
Part Number	Product part number.
System Version	Firmware version. This is the main software release version.
Recovery Version	Recovery image version.
Boot Version	Bootling code version.
Kernel Version	Kernel version.
Android™ Version	Android™ OS version: 4.4.2.
System Up Time	System up time since the last reboot.

Status – System Info

Status – Storage Info

Storage Info pages displays the available and used space of GAC2500 internal storage and SD card, the following screenshot show an example of the storage info.

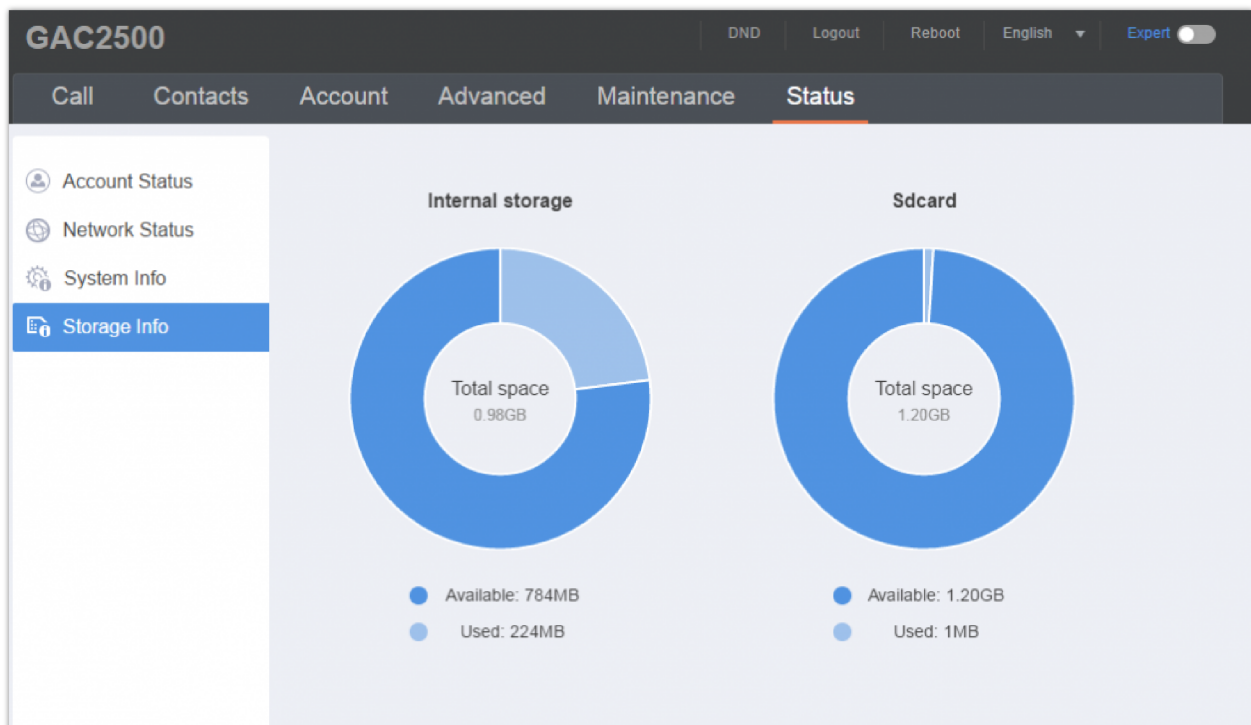

GAC2500 Storage Info

CALL FEATURES

GAC2500 supports traditional and advanced call features, including CID, Display Caller's name, call transfer, etc. Login the Web page and go to Account→Call Settings and select "Yes" in the checkbox behind the option "Activate Call Features" then use the following codes to realize synchronized settings on the corresponding web page.

Code	Feature
*01	Select the preferred codec used for the call (One-time Only) Dial *01+preferred codec+Phone/Ext. Number PCMU preferred codec: 7110 PCMA preferred codec: 7111 G726.32 preferred codec: 72632 G722 preferred codec: 722 ILBC preferred codec: 7201
*02	Force the unique codec used for the call. Dial *02+preferred codec+Phone/Ext. Number
*16	Force SRTP used for the call. Dial *16
*17	Disable SRTP Dial *17
*18	Enable SRTP (One-time Only) Dial *18+Phone/Ext. Number
*19	Disable SRTP (One-time Only) Dial *19+Phone/Ext. Number
*30	Anonymous Call (For all subsequent calls) Dial *30
*31	Cancel Anonymous (For all subsequent calls) Dial *31
*50	Disable Call Waiting (For all subsequent calls) Dial *50
*51	Call Waiting (For all subsequent calls) Dial *51
*67	Selective Anonymous Call (Current Call) Dial *67+Phone/Ext. Number Dial
*70	Disable Call Waiting (For all subsequent calls) Dial *70+Phone/Ext. Number Dial
*71	Enable Call Waiting (For all subsequent calls) Dial *77+Phone/Ext. Number Dial

*72	Unconditional Call Forward: Set up unconditional call forward Dial *72 + Phone/Ext. Number. Dial
*73	Cancel Unconditional Call Forward: Cancel unconditional call forward Dial *73
*74	Enable paging mode directly when dialing up Dial *74
*82	Selective Cancel Anonymous Call (Current Call) Dial *82+Phone/Ext. Number Dial
*90	Busy Call Forward: Set up busy call forward Dial *90 + Phone/Ext. Number. Dial
*91	Cancel Busy Call Forward: Cancel busy call forward Dial*91
*92	Delayed Call Forward: Set up delayed call forward Dial *92 + Phone/Ext. Number. Dial
*93	Cancel Delayed Call Forward: Cancel busy call forward Dial*93
***3424*	Access the factory diagnosis app Dial ***3424*

Feature Codes

UPGRADING AND PROVISIONING

GAC2500 supports software upgrade via TFTP /HTTP/HTTPS server. Please go to Maintenance →Upgrade to configure.
GAC2500 supports the following upgrade modes:

- Manual upload firmware file to upgrade
- Upgrade via TFTP firmware server
- Upgrade via HTTP/HTTPS firmware server

Upgrade and Provisioning Configuration

There are two ways to setup upgrade and provisioning on GAC2500. They are Keypad Menu and Web GUI.

Configure via Keypad Menu

In GAC2500 Settings, select **Advanced Settings**→**Upgrade**. Users may then select the upgrade mode and enter the IP address or FQDN for the Firmware server and the Config server. After making the changes, tap **Ok** button to save the change. Then reboot the phone.

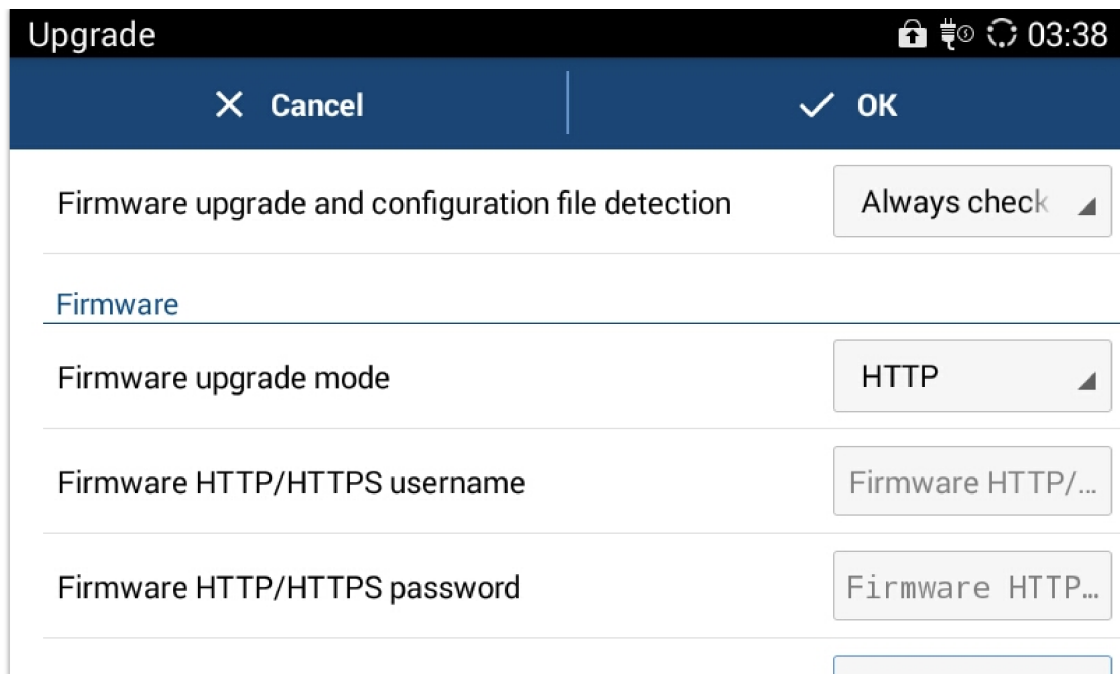

GAC2500 Upgrade Configuration via LCD

Configure via Web GUI

Open a web browser on PC and enter the IP address for the GAC2500. Then login with the administrator username and password. Go to Maintenance section, select Upgrade tab. In the Upgrade web page, enter the IP address or the FQDN for the upgrade server and choose to upgrade via TFTP, HTTP or HTTPS (The default setting is HTTPS). Save and apply the changes, then reboot the phone.

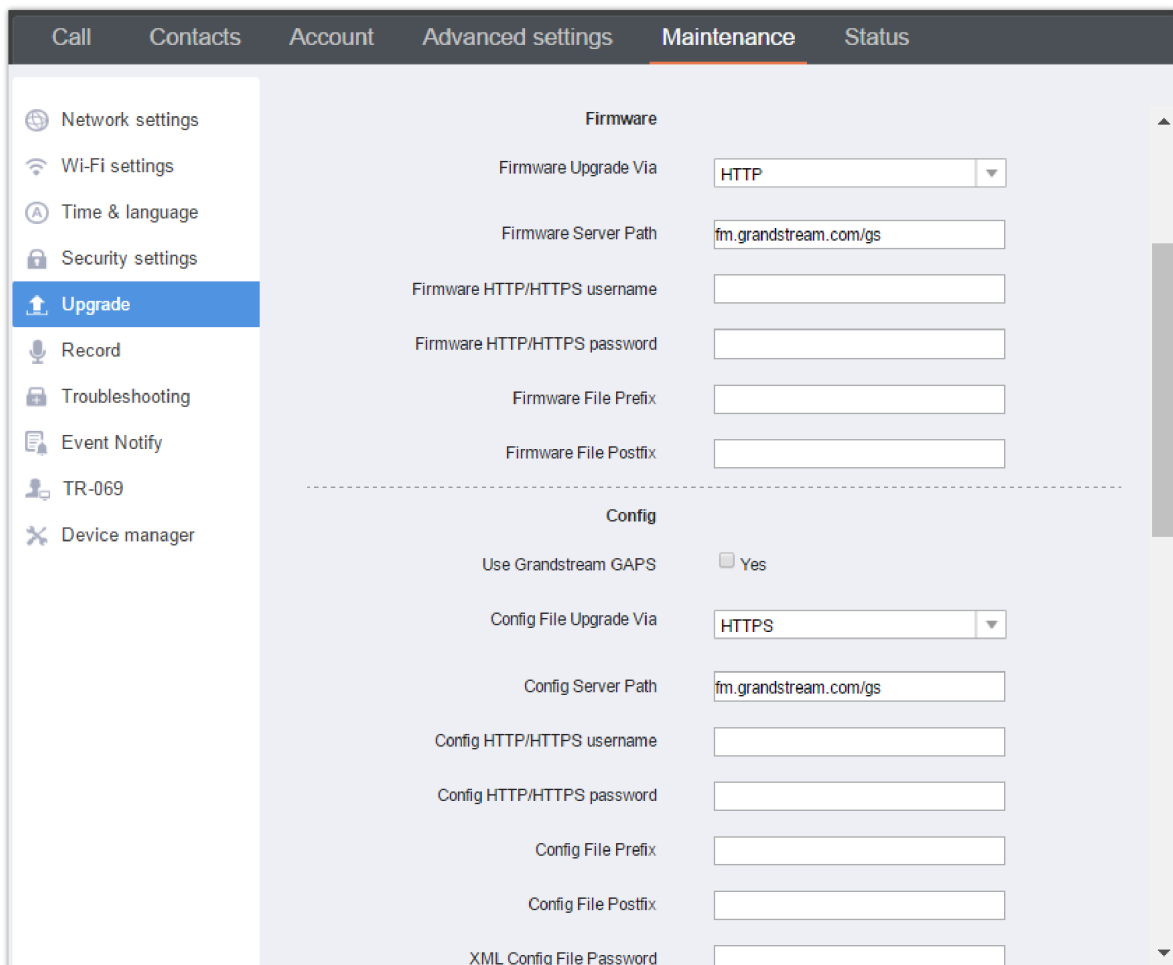

GAC2500 Upgrade Configuration via Web GUI

Upload Firmware Locally

If there is no HTTP/TFTP server, users could also upload the firmware to the GAC2500 directly via Web GUI. Please follow the steps below to upload firmware to GAC2500 locally.

Notes

1. It is HIGHLY recommended that use an Uninterruptible Power Supply (UPS) or it might be fail if emergency cutoff occurs in the process of update.
2. Please unpack the compression package before upgrade when manual update.
3. Please download the firmware file by visiting our website www.grandstream.com/support/firmware.
4. Please do not power off or unplug the GAC2500 when the upgrading process is on.

Download the latest GAC2500 firmware file from the following link and save it in your PC.
<http://www.grandstream.com/support/firmware>

Log in the Web GUI as administrator in the PC.

Go to Web GUI→**Maintenance**→**Upgrade**, configure Upgrade Via as “Manually Upload”.

Click the “Upload” button, a window will be prompted to select firmware file to upload.

1. Select the firmware file from your PC. Then uploading progress will show at the button where it was “Upload” in the above step.
2. When uploading is done, users can see the upgrading process starts on the GAC2500 LCD.
3. The phone will reboot again with the new firmware version upgraded.

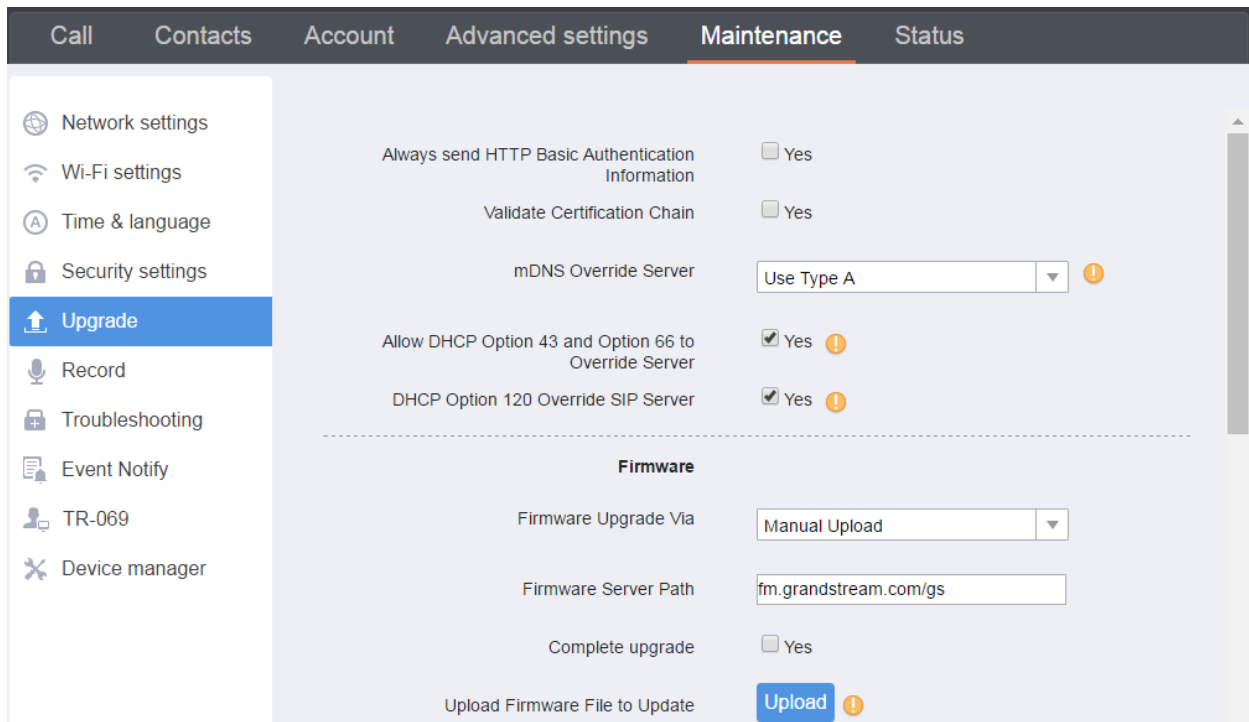

Upload Firmware Locally

No Local Firmware Servers

Service providers should maintain their own firmware upgrade servers. For users who do not have a TFTP/HTTP/HTTPS server, some free Windows version HTTP/TFTP servers are available for download from: <https://support.solarwinds.com/> and <http://tftpd32.jounin.net/>.

Please check our web site at <http://www.grandstream.com/support/firmware> for latest firmware.

Instructions for firmware upgrade:

1. Unzip the firmware files and put all of them in the root directory of the TFTP server;
2. Connect the PC running the TFTP server and the GAC2500 device to the same LAN segment;
3. Launch the TFTP server and go to the File menu → **Configure** → **Security** to change the TFTP server's default setting from "Receive Only" to "Transmit Only" for the firmware upgrade;
4. Start the TFTP server and configure the TFTP server in the phone's web configuration interface;
5. Configure the Firmware Server Path to the IP address of the PC;
6. Update the changes and reboot the GAC2500.

End users can also choose to download a free HTTP server from <http://httpd.apache.org/> or use Microsoft IIS web server.

Provisioning and Configuration File Download

Grandstream SIP Devices can be configured via the Web Interface as well as via a Configuration File (binary or XML) through TFTP or HTTP/HTTPS. The "Config Server Path" is the TFTP, HTTP or HTTPS server path for the configuration file. It needs to be set to a valid URL, either in FQDN or IP address format. The "Config Server Path" can be the same or different from the "Firmware Server Path".

A configuration parameter is associated with each particular field in the web configuration page. A parameter consists of a Capital letter P and 2 to 3 (Could be extended to 4 in the future) digit numeric numbers. i.e., P2 is associated with the "Admin Password" in the Web GUI → **Maintenance** → **Security** Settings page. For a detailed parameter list, please refer to the corresponding firmware release configuration template in the following link: <http://www.grandstream.com/support/tools>

When the GAC2500 boots up, it will issue TFTP or HTTP request to download a configuration XML file named "cfgxxxxxxxx" followed by "cfgxxxxxxxx.xml", where "xxxxxxxx" is the MAC address of the phone, i.e., "cfg000b820102ab" and "cfg000b820102ab.xml". If downloading "cfg[MAC].xml" file is not successful, the phone will issue a request to download a specific model configuration file "cfggac2500.xml". If this file is not available, the provision program will download a generic "cfg.xml" file. The configuration file name should be in lower case letters. For more details on XML provisioning, please refer to the following document:

<https://documentation.grandstream.com/knowledge-base/sip-device-provisioning-guide/>

P22421 to control reboot on provision. When set to 1 in the config file, the device will always reboot on provision.

Provision as Provision Server (PNP)

GAC2500 provides the Provision Server app for batch provision. The app setting is shown as follows:

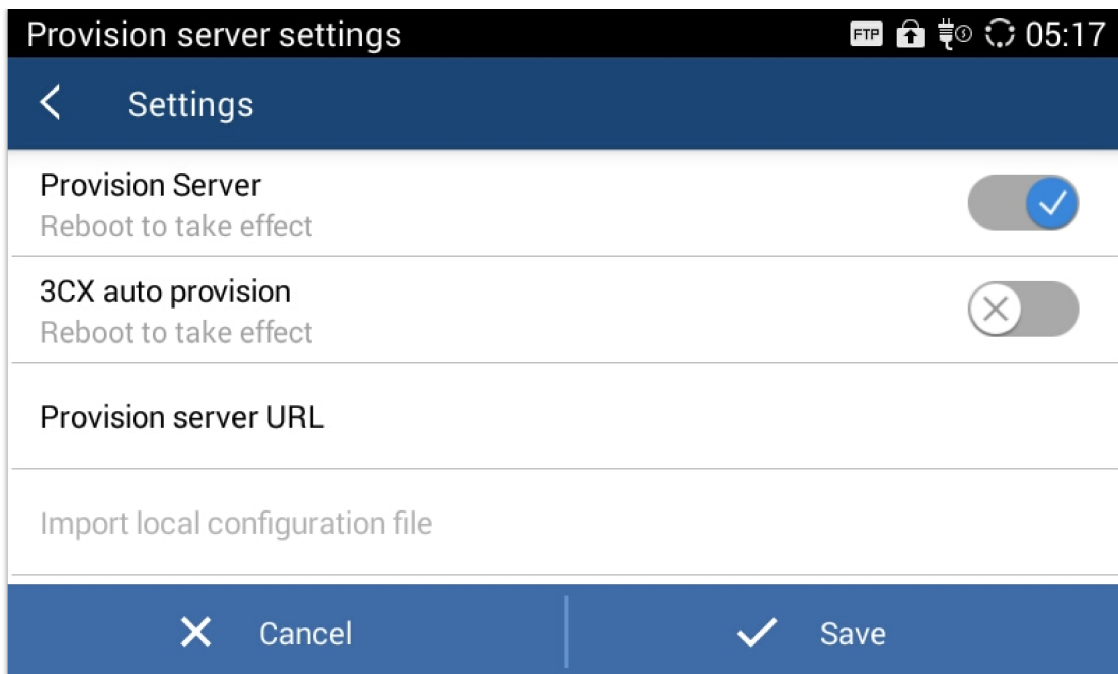

Provision Server Settings

Parameters	Description
Provision Server	Enables the PNP (Plug and Play) feature on the device. If it is enabled, the device will be set as a provision server to send SIP NOTIFY message including the provision URL to response the client phone's SIP SUBSCRIBE request. This feature will be enabled if the PNP URL is configured. If this setting is enabled, the 3CX Auto provision will be disabled automatically. Meanwhile, device would check whether SIP port is 5060. If SIP port is 5060, device would have a reminder to change the port number to a random one.
3CX auto provision	Sets the phone system to broadcast the SIP SUBSCRIBE message during booting up to allow itself to be discovered and be configured by the SIP platform. The procedure requires support from 3CX SIP server.
Provision Server URL	Configures PNP file URL address. The address needs protocol type, such as http/https/tftp. You can also tap on "Local" to auto fill in local address, such as, "http://192.168.121.111/pnp". So, users need to save the cfg file to /Internal Storage/pnp/ directory.

Provision Server Settings

After configuring the PNP provision, please reboot the device to take effect. After the provision takes effect, all the device in the same LAN would send SUBSCRIBE to GAC after boot up. Based on the information received to complete provision.

When using Provision Server, users can view the records of provision, shown as below:

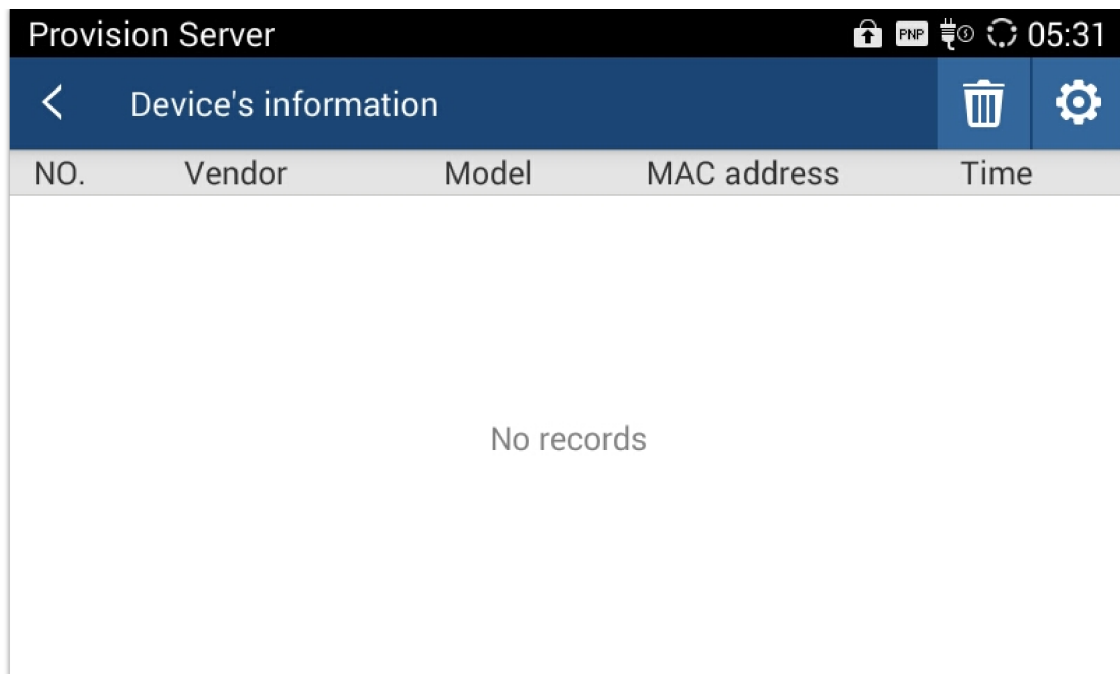

Provision Record

Note

When the prompt in the figure below shows up, it means the firmware/config authentication failed. So the user will be required to check the username/password on device web UI → Maintenance → Upgrade:

- Firmware HTTP/HTTPS username
- Firmware HTTP/HTTPS password
- Config HTTP/HTTPS username
- Config HTTP/HTTPS password

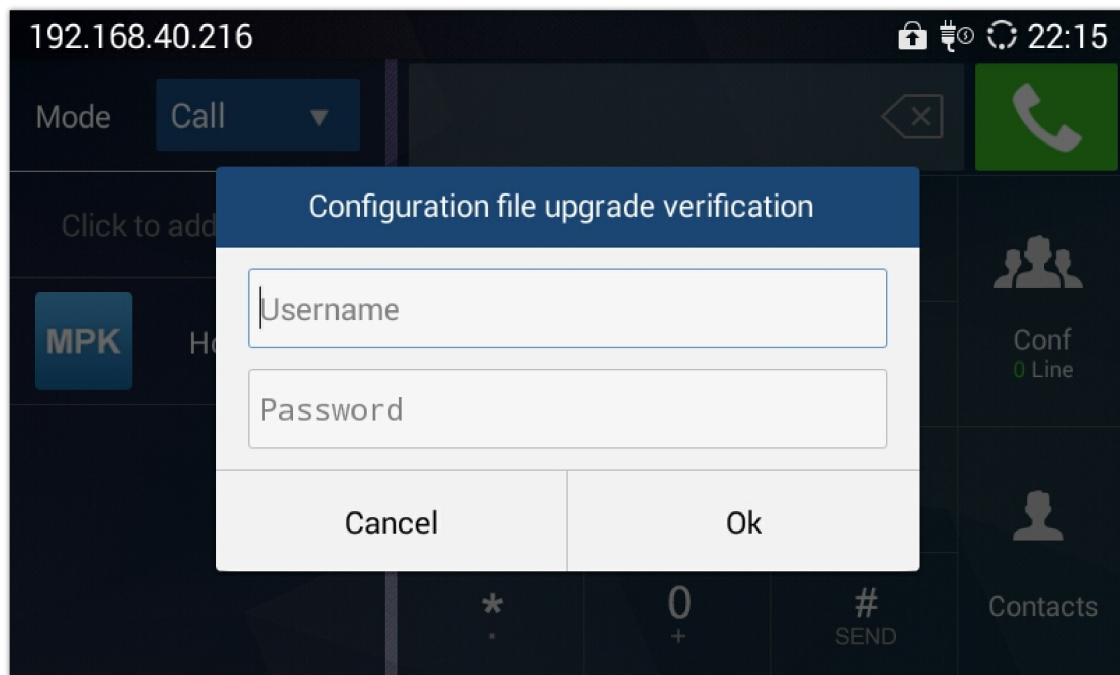

Config File Upgrade Verification

BACKUP

GAC2500 provides Backup app to support backup the data and restore data by importing backup files. The interface is shown as follows.

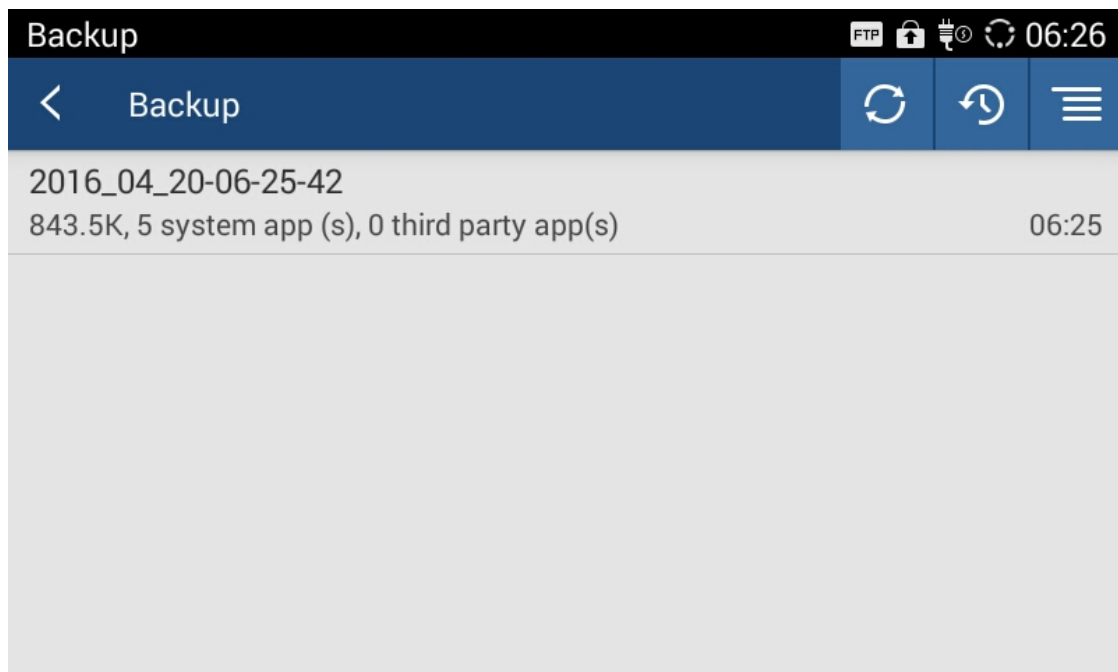

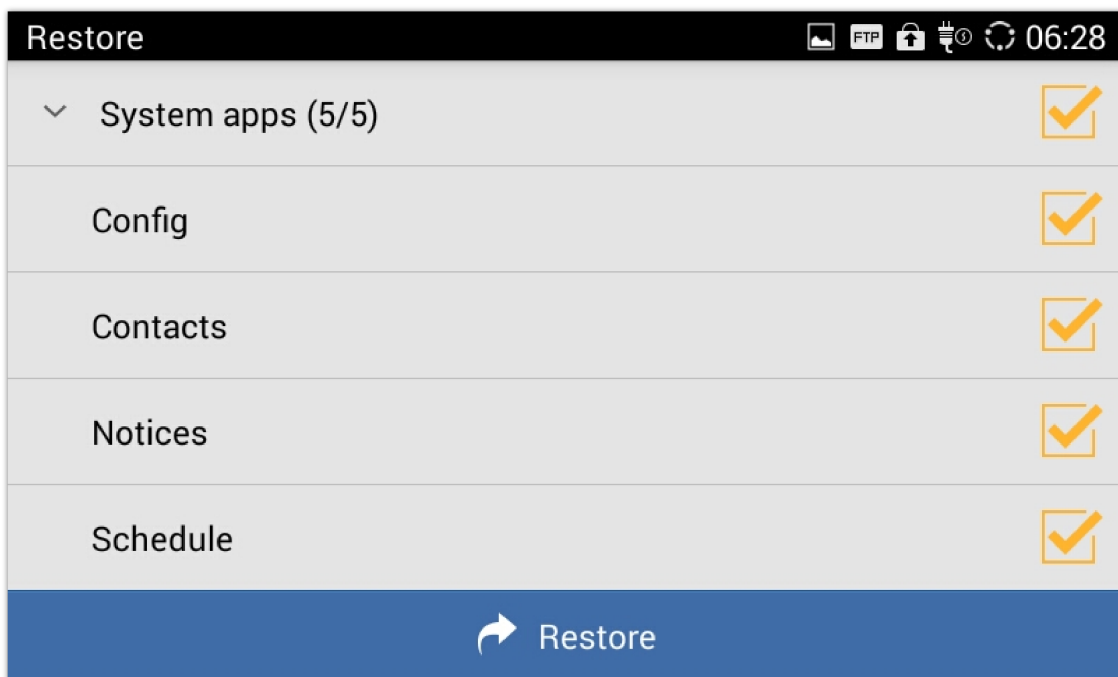

Backup Files List

Users can tap on  to import backup files from external storage. Tapping on one file to enter the page shown below. Choose part of the data and tap on "Restore" to recover.



Select Data to Restore

 GAC2500 supports manual or automatic backup. First, tap on  to select data to backup. Then tap on and select "Auto backup" to schedule an automatic backup

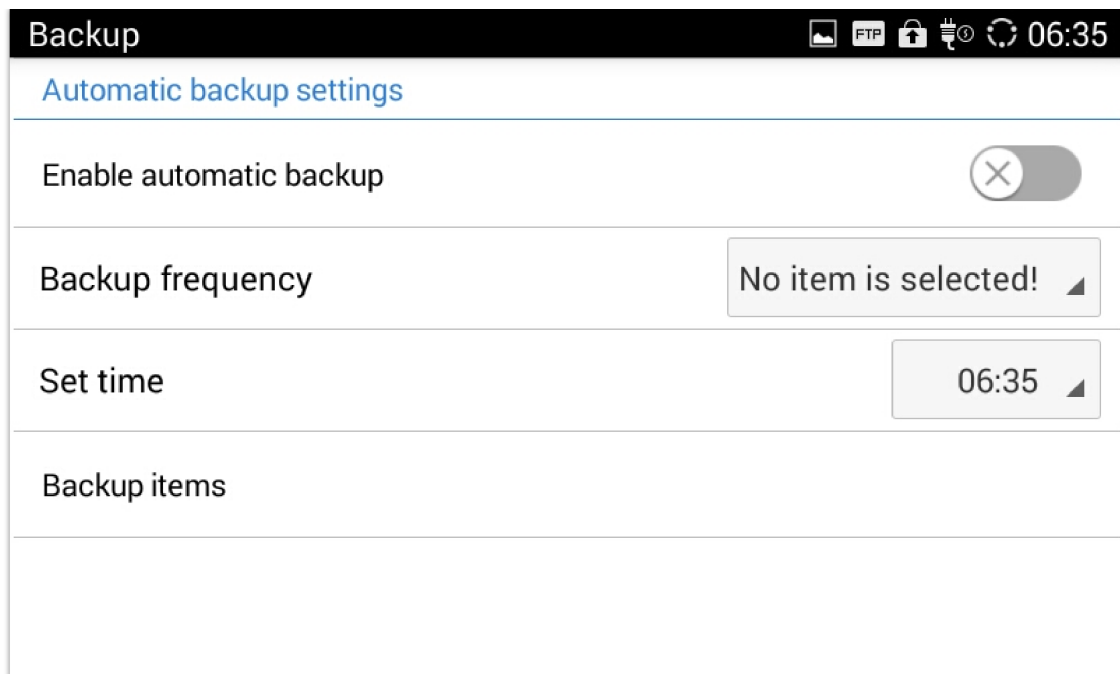

Auto Backup Settings

Users can also configure the directory to store backup files, as shown below.

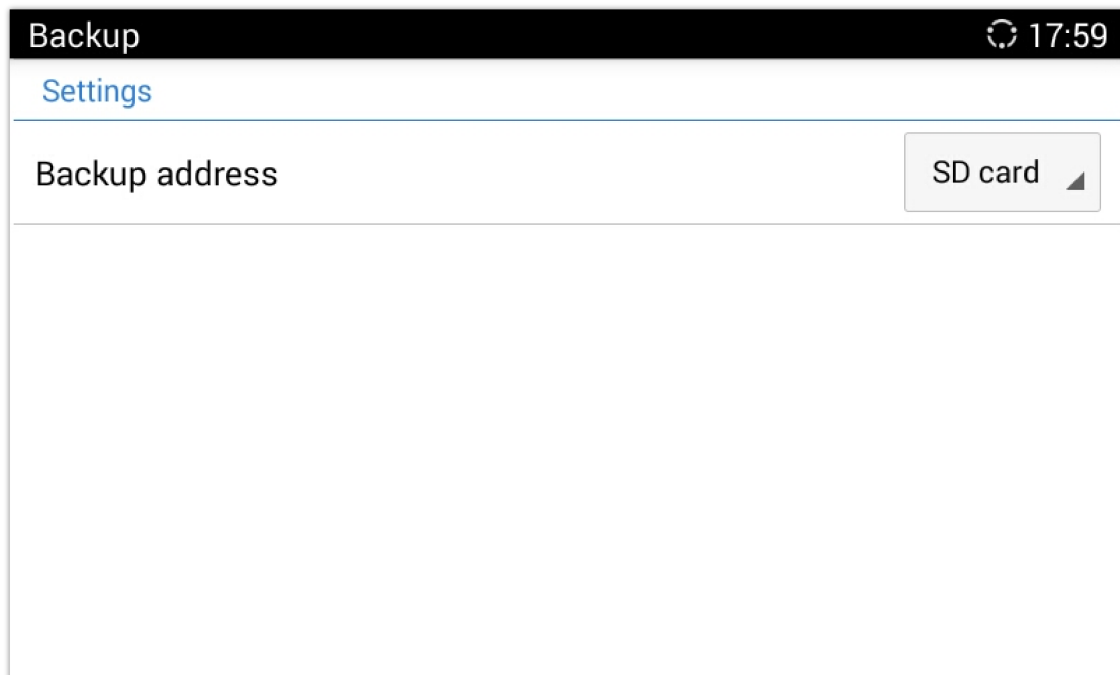

Configure Backup Files Directory

FACTORY RESET

Warning

Restoring the Factory Default Settings will delete all configuration information on the phone. Please backup or print all the settings before you restore to the factory default settings. Grandstream is not responsible for restoring lost parameters and cannot connect your device to your VoIP service provider.

Users could reset factory settings via the following ways: Reset via local GUI, via Web page, via the reset button on the back panel of GAC2500. Factory reset will delete configuration info and syslog info, the HDD data and videos will not be deleted.

Restore to Factory Default via LCD Menu

Access to the GAC2500 LCD Settings→Advanced Settings→Factory Reset, tap on Factory Reset, a confirmation message will be displayed. Tap on **OK** to confirm or return to avoid.

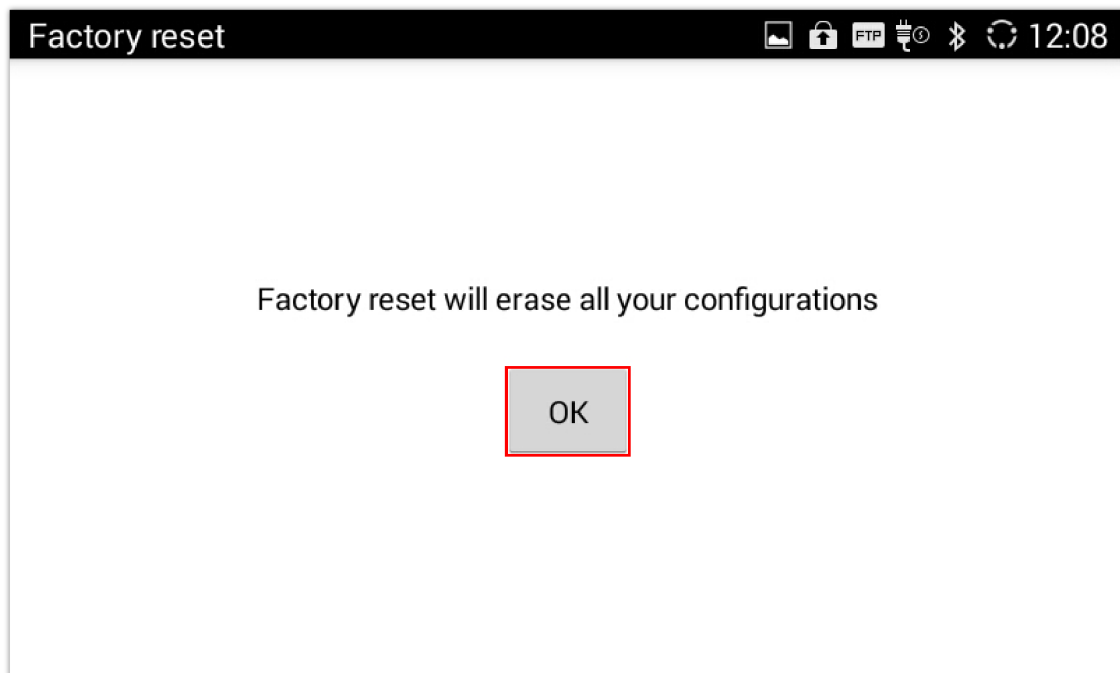
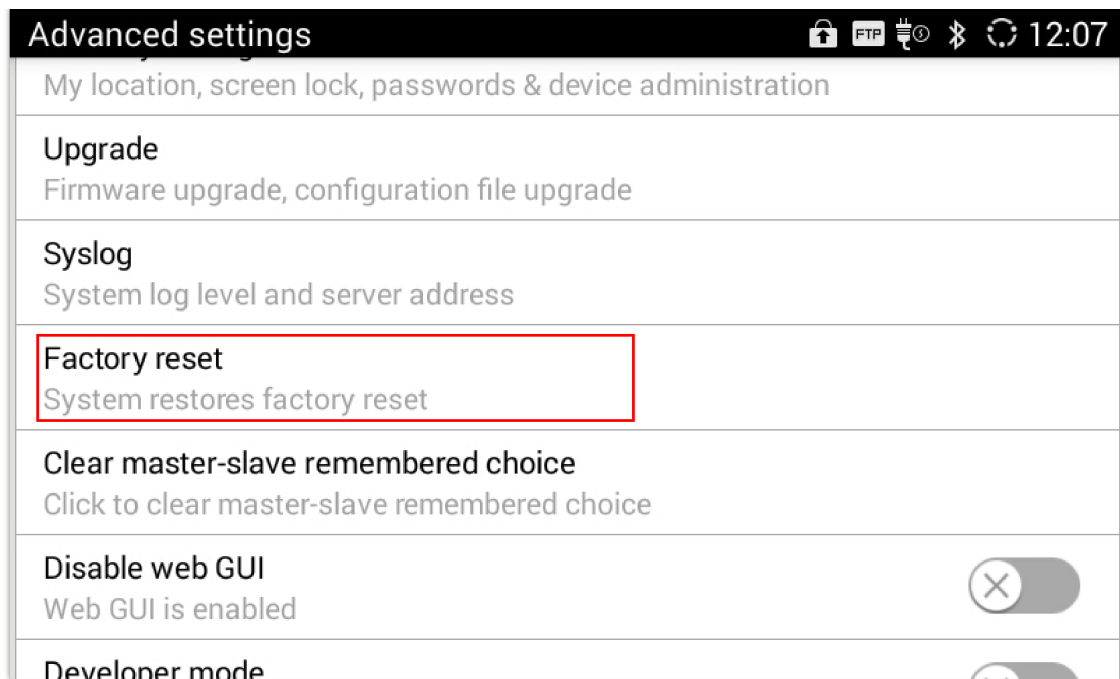

Restore to Factory Default via the Web GUI

1. Access to the GAC2500 Web GUI → **Maintenance**→**Upgrade** page.
2. At the bottom of the page, click on the **Reset** button for Factory reset. Select whether you would like to clear the SD card if there is SD card plugged in.

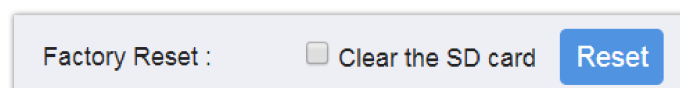

Factory Reset on Web UI

3. A dialog box will pop up to confirm factory reset;

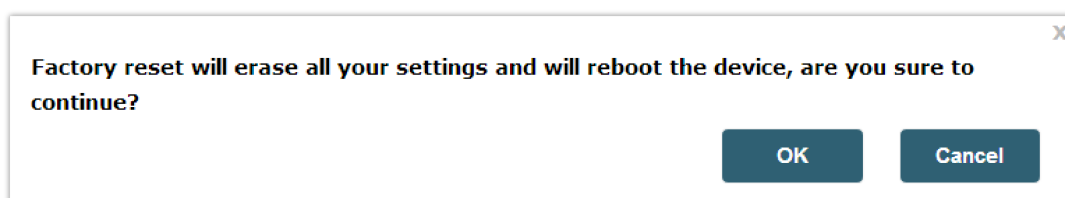

Web UI – Factory Reset Confirmation

4. Click **OK** to restore the phone to factory settings.

Reset Via Button

Use a small pin to press the button Reset button on the back panel of GAC2500 for more than 10 seconds to reboot and restore to factory reset.

EXPERIENCING THE GAC2500 APPLICATION PHONE

Please visit our website: <http://www.grandstream.com> to receive the most up- to-date updates on firmware releases, additional features, FAQs, documentation and news on new products.

We encourage you to browse our [product related documentation](#), [FAQs](#) and [User and Developer Forum](#) for answers to your general questions. If you have purchased our products through a Grandstream Certified Partner or Reseller, please contact them directly for immediate support.

Our technical support staff is trained and ready to answer all of your questions. Contact a technical support member or [submit a trouble ticket online](#) to receive in-depth support.

Thank you again for purchasing Grandstream Enterprise Application phone, it will be sure to bring convenience and color to both your business and personal life.

* **Android is a trademark of Google Inc.**

* **Skype and Lync are Registered Trademarks of Microsoft Corporation.**

CHANGE LOG

This section documents significant changes from previous versions of GAC2500 user manuals. Only major new features or major document updates are listed here. Minor updates for corrections or editing are not documented here.

Firmware Version 1.0.3.48

- No major Changes.

Firmware Version 1.0.3.47

- No major Changes.

Firmware Version 1.0.3.45

- Supported TLS version 1.2 when downloading contacts.

Firmware Version 1.0.3.42

- Supported provision fails over to config server path when the device fails to provision from DHCP Option. [[maintenance-network-settings](#)]
- Supported P22421 to control reboot on provision. When set to 1 in the config file, the device will always reboot on provision. [[provisioning-and-configuration-file-download](#)]

Firmware Version 1.0.3.38

- No major changes.

Firmware Version 1.0.3.37

- No major changes.

Firmware Version 1.0.3.35

- Supported BroadWorks Xtended Services Interfaces (XSI) features. [[Contacts – BroadSoft](#)]
- Supported one-click debug function. [[One-Click Debugging](#)]

Firmware Version 1.0.3.30

- Supported Ignore early media in conference in web UI → Advanced Settings → Call features. [[Ignore early media in conference](#)]

Firmware Version 1.0.3.27

- Replaced expired pem certificate for security improvement.
- Set the default value of Cust file download mode to HTTP. [[Cust File Upgrade Via](#)]
- Added a prompt for RTCP destination address if port number is not offered. [[RTCP Destination](#)]
- Supported adding custom CA certificate to device under web UI → Advanced Settings → General Settings. [[Custom Certificate](#)]

Firmware Version 1.0.3.20

- Updated the random automatic upgrade configuration so it can take effect without reboot.
- Optimize Bluetooth performance.
- Added support for TLSv1.1 and TLSv1.2. [[Security](#)]
- Updated web UI → Maintenance → Network settings → Layer 3 QoS for SIP default value to 26, Layer 3 QoS for Audio to 46. [[Layer 3 QoS](#)]
- Added support for auto download firmware/configuration files randomly in time window. [[Enable Randomized Automatic Upgrade](#)]
- Removed icon for reboot from web UI → Advanced Settings → General Settings → "STUN Server", "Use NAT IP" and "SIP TLS Private Key" settings. [[General Settings](#)]
- Added admin password authentication for factory reset if the "Configuration via Keypad Menu" is set to Constraint mode or Basic settings only. Press the same number key multiple times to generate letters. And press "#" to confirm the password. [[Admin authentication](#)]

Firmware Version 1.0.3.17

- Added DNS SRV Fail-over Mode under web UI → Account → Network Settings → DNS SRV Fail-over Mode. [[DNS SRV Fail-over Mode](#)]
- Supported 4 types of Internet Protocol: IPv4 only, IPv6 only, Both but prefer IPv4, Both but prefer IPv6. [[Preferred Internet Protocol](#)]
- Added Syslog protocol and Syslog keyword filter for Syslog. [[Syslog](#)]
- Added string validation for web UI → Advanced settings → General settings → Guest Login PIN Code [[Guest Login PIN Code](#)]
- Added default value "***" for web UI → Advanced Settings → MPK General Settings → BLF Call-pickup Prefix [[BLF Call-pick Prefix](#)]
- Updated some Chinese translation in web UI.
- Updated tooltips in web UI.
- Increased the length of configuration "Syslog server address" on web UI from 32 characters to 128 characters [[Syslog Server Address](#)]
- Supported contact download server using IPv6 address with subdirectory. [[Download server](#)]
- Supported IPv6 address for Syslog server. [[Syslog](#)]
- Supported IP call via TCP transport. [[IP Call](#)]
- Supported new config file format: cfggac2500.xml for GAC2500 [[model configuration file](#)]
- Removed SIP server field validation in web UI.
- Updated feature code to access factory diagnosis app. The feature code is "****3424*". [[***3424*](#)]

Firmware Version 1.0.3.13

- Updated tool tip for web UI → Maintenance → Network settings → Bypass Proxy For, Multiple IP addresses can be separated by ",". [[Maintenance – Network Settings](#)]

- Updated that DUT does not support multicast paging using port 0. [[Advanced Settings – Multicast Paging](#)]

Firmware Version 1.0.3.11

- Added support for RED with FEC. [[Enable Audio RED with FEC](#)]
- Updated default NTP server address. [[Specify NTP Server Address](#)]

Firmware Version 1.0.3.5

- Supported IPv6. [[IPv6 address](#)]
- Supported setting Wi-Fi from web UI → Maintenance. [[Maintenance – Wi-Fi Settings](#)]
- Added input inspection of multicast paging on web UI. [[Multicast paging](#)]
- Added support for DHCP Option 132 & 133 tunneled through DHCP Option 43. [[DHCP VLAN Override](#)]
- Added “Medium room & Rich voice” and “Medium Room & Clear Voice” option. [[Voice Mode](#)]
- Added support to disable SSH without reboot. [[Disable SSH](#)]
- On web UI MPK settings, Multicast Paging does not need to set the account. [[Advanced Settings – Multicast Paging](#)]
- Removed “Hide Local Call History” under web UI → Advanced → General Settings.
- Added contact categories when creating a new conference in web UI. [[Contacts – Schedule](#)]
- Changed web UI LDAP Max Hits valid range to 0 – 4000. [[Max Hits](#)]
- Updated tooltip for “Complete upgrade” and “Unregister before new registration”. [[Complete Upgrade](#)]
- Added more voice mode “Medium room & Rich voice”, “Medium Room & Clear Voice”, “Small room & Denoise”, and “Small & Enhanced Denoise”. [[Voice Mode](#)]
- Added support for “Hide Vocoder”. When set to “Yes”, the codec information in an active call will be hidden. [[Hide Vocoder](#)]
- Changed the layout of creating new group on web UI. [[Contacts – Groups](#)]
- Synchronized the mute icon of minimized call interface on web UI. [[Mute Icon](#)]
- Added Core dump feature. [[Core Dump](#)]
- Added “Disable web GUI”. [[Disable web GUI](#)]
- Updated description under Contacts → LDAP page. [[LDAP](#)]
- Added support for fixed slave mode in web UI. [[Fixed Slave Mode](#)]
- Added “User Authority Management” for admin under Web UI. [[User Authority Management](#)]
- Added support for special control character ‘T’ in dialplan. [[Dial Plan](#)]
- Added “Intercom barging” in Web UI. [[Intercom Barging](#)]
- Added support for dialing multiple members in Conf room during a call on web UI. [[Conference Room](#)]

Firmware Version 1.0.1.45

- Added support for new hardware version. [[Hardware version number](#)]

Firmware Version 1.0.1.44

- No major changes

Firmware Version 1.0.1.40

- Added Guest Login option. [[Guest Login](#)]
- Hided ‘Virtual Account Group’ setting, only visible under expert mode. [[Virtual Account Group](#)]

Firmware Version 1.0.1.34

- Dial plan improvements, supports direct IP call. [[Dial Plan](#)]
- Added UCM auto config number in Advanced Account settings. [[UCM Auto Config Number](#)]
- Added Codec Negotiation Priority in Codec & RTP settings. [[Codec Negotiation Priority](#)]

- Added Enable Conference Room Quite Mode. [[Enable Conference Room Quite Mode](#)]

Firmware Version 1.0.1.26

- Removed In-Call Sound EQ and added Voice Mode. [[Voice Mode](#)]
- Added Conference Mode option. [[Conference Server](#)]
- Added Mute Indicator control for device. [[Mute Indicator](#)]
- Added Recorder Editing from web UI. [[Record Mode](#)]
- Added storage information on web UI. [[Status – Storage Info](#)]
- Added Constraint Mode option in Configuration via Keypad Menu. [[Configuration via Keypad Menu](#)]
- Added Provision Server app. [[Provision as Provision Server \(PNP\)](#)]
- Added backup app. [[BACKUP](#)]
- Updated Advanced settings in LCD. [[Advanced Settings](#)]

Firmware Version 1.0.1.18

- Increased call history to 2000 entries. [[Telephony Features](#)]
- Updated 3.5mm AUX line sequence interface. [[Auxiliary Ports](#)]
- Updated the chapter of third party application. [[Sample Applications](#)]

Firmware Version 1.0.1.16

- This is the initial version.

Need Support?

Can't find the answer you're looking for? Don't worry we're here to help!

[CONTACT SUPPORT](#)