



Grandstream Networks, Inc.

GAC2500

User Guide



GAC2500 - User Guide

WELCOME

Thank you for purchasing Grandstream GAC2500 Audio Conference Phone for Android™. This User Guide describes the basic concept and tasks necessary to use and configure your GAC2500. This document covers the topics of conference environment setups, start conference and the relevant operations like conference reservation. To learn the advanced features and configurations, please visit <http://www.grandstream.com> to download the latest "GAC2500 Administration Guide".

GAC2500 is a next generation enterprise-grade 6-line Android IP conference phone with a 4.3" capacitive touch screen that runs the Android Operating System and therefore offers full access to the hundreds of thousands of Android apps in the Google Play Store, including business productivity apps such as Skype™, Skype for Business™, and Google Hangouts™. The phone features Gigabit ports, 7-way conference, 3x microphones, 1 Micro USB port, integrated WiFi and Bluetooth for network flexibility. The GAC2500 delivers superior HD audio quality, rich and leading-edge telephony features, automated provisioning for easy deployment, advanced security protection for privacy, and broad interoperability with most 3rd party SIP devices and leading SIP/NGN/IMS platforms. GAC2500 is a perfect choice for enterprise users looking for a high performance, feature rich conference phone with superb audio quality at competitive price.

PRODUCT OVERVIEW

Feature Highlights

The following tables contain the major features of the GAC2500:

 <p>GAC2500</p>	<ul style="list-style-type: none">• Runs Android™ 4.4 and offers full access to all Android™ conference apps in the Google Play Store (e.g., Skype™, Skype for Business™, Google Hangouts™, etc.)• World-class high-fidelity sound quality with audio bandwidth of up to 18Khz• 4.3" capacitive touch screen LCD with support for flexible layout/content customization• 3x microphones (12 ft. pickup range), 1x speaker (15 ft. coverage range)• Auto-sensing Gigabit Ethernet port, Wi-Fi, PoE+, Bluetooth, Micro-USB with 3.5mm audio interface• Supports standalone IP mode or USB slave mode• Supports daisy chain (up to 2 units via RJ48 CAT5) mode in large conference room for better audio quality• NAT-T enables the phone being the Plug and Play device• Automated provisioning using TR-069 or AES encrypted XML configuration file, TLS/SRTP/HTTPS for advanced security and privacy protection
--	---

GAC2500 Features in a Glance

GAC2500 Technical Specifications

The following table resumes all the technical specifications including the protocols / standards supported, voice codecs, telephony features, languages and upgrade/provisioning settings for the GAC2500.

Protocols/Standards	SIP RFC3261, TCP/IP/UDP, RTP/RTCP, HTTP/HTTPS, ARP, ICMP, DNS (A record, SRV, NAPTR), DHCP, PPPoE, SSH, TFTP, NTP, STUN, SIMPLE, LLDP, LDAP, TR-069, 802.1x, TLSv1.1, TLSv1.2, SRTP, IPv6, OpenVPN (pending)
Voice Codec	Support for G.711μ/a, G.722, G.726, iLBC, Opus, G.722.1 and G.722.1c (pending), in-band and out-of-band DTMF (In audio, RFC2833, SIP INFO), G.729A/B, VAD, CNG, AEC, PLC, AJB, AGC

Platform Bridging	Bridge SIP calls with any Android™ VoIP apps such as Skype™, Skype for Business (Lync), Google Hangouts™ and more
Telephony Features	Hold, transfer, forward (unconditional/no-answer/busy/conditional), call park/pickup, 7-way audio conference, auto answer, downloadable XML phone book (up to 2000 entries), LDAP, call waiting, call history (up to 2000 entries), flexible dial plan, personalized music ringtones, server redundancy & fail-over.
Sample Applications	Skype™, Google Hangouts™, Skype for Business (Lync), Web browser, Facebook™, Twitter™, YouTube, Google calendar, mobile phone data import/export via Bluetooth, etc. API/SDK available for advanced custom application development
Application Deployment	Allows Android 4.4 compliant applications to be deployed in the device with provisioning control
QoS	Layer 2 QoS (802.1Q, 802.1p) and Layer 3 (ToS, DiffServ, MPLS) QoS
Security	User and administrator level passwords, MD5 and MD5-session based authentication, 256-bit AES encrypted configuration file, TLSv1.1, TLSv1.2, 128/256-bit SRTP/TLS, HTTPS, 802.1x media access control
Multi-Language	English, German, Italian, French, Spanish, Portuguese, Russian, Turkish, Polish, Chinese, Korean, Japanese, and more
Upgrade/ Provisioning	Firmware upgrade via TFTP / HTTP / HTTPS or local HTTP upload, mass provisioning using TR-069 or AES encrypted XML configuration file
Network Interface	1x auto-sensing Gigabit Ethernet port, integrated 2.4GHZ auto-band Wi-Fi (802.11a/b/g/n) and Bluetooth.
HD Audio	3x microphones (12 ft. pickup range), 1x speaker (220-18,000 Hz, 15 ft. coverage range up to 86dB)
Auxiliary Ports	3.5mm audio interface, Micro-USB interface, RJ48 interface, reset pin
Graphic Display	4.3" (800*480) capacitive touch screen LCD
Power & Green Energy Efficiency	Universal power adapter included: Input: 100-240VAC 50-60Hz; Output: 12VDC, 2A (24W)
Temperature and Humidity	Operating: 32 – 104oF / 0 – 40oC Storage: 14 – 140oF / -10 – 60oC Humidity: 10% to 90% Non-condensing
Compliance	FCC: Part 15 (CFR 47) Class B; UL 60950 (power adapter) CE: EN55022 Class B, EN55024, EN61000-3-2, EN61000-3-3, EN60950-1, EN62479, RoHS RCM: AS/ACIF S004; AS/NZS CISPR22/24; AS/NZS 60950; AS/NZS 4268

GAC2500 Technical Specifications

GETTING STARTED

This chapter provides basic installation instructions including the list of the packaging contents and also information for obtaining the best performance with the GAC2500.

Equipment Packaging

GAC2500
<ul style="list-style-type: none"> • 1 x GAC2500 Main Case. • 1 x 12V Power Adapter. • 1 x Ethernet Cable • 1 x Micro-USB Cable • 1 x RJ48 CAT5 • 1 x Quick Installation Guide • 1 x GPL License

Equipment Packaging

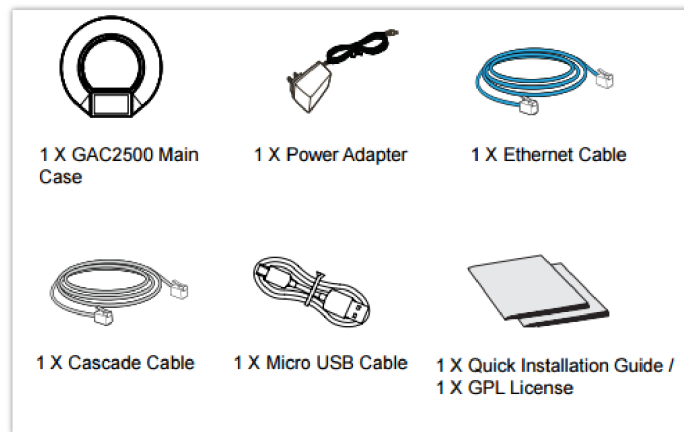

Package Content

Important

Check the package before installation. If you find anything missing, contact your system administrator.

Product Appearance

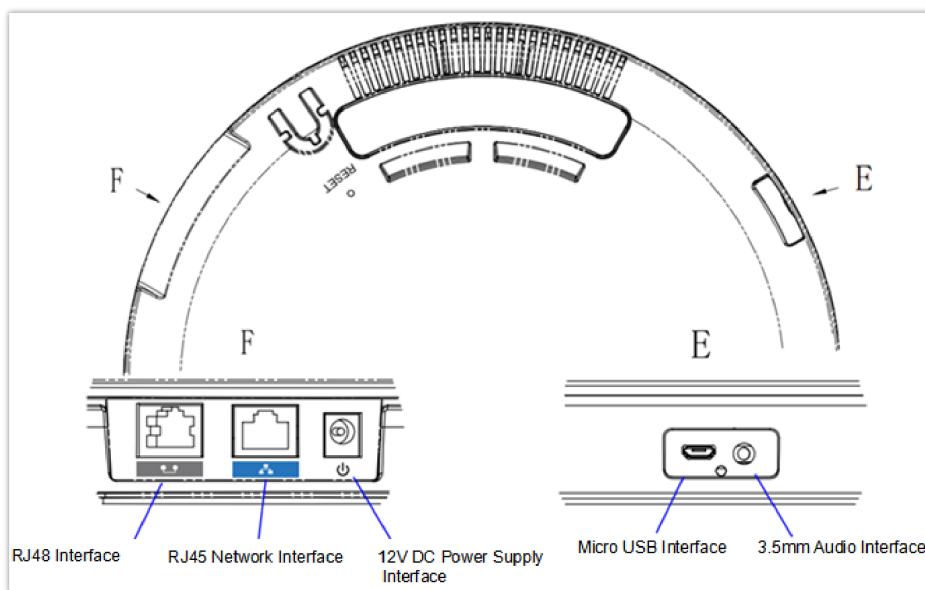

GAC2500 Host Interface

Name	Explanation

RJ48 Interface	Daisy chain (up to 2 units via RJ48 CAT5) mode in large conference room for better audio quality.
RJ45 Network Interface	Connect to LAN port.
12V DC Power Supply Interface	Connect to Power Adaptor.
Micro USB Interface	USB OTG devices can be connected to GAC2500 via the USB cable. For example, connect a USB flash drive to read data, or PC USB Interface or GVC32XX SPKR Interface can be connected to the GAC2500 USB Interface via USB cable for audio pickup and play
3.5mm Audio Interface	Connect to 3.5mm devices like mobile phone or PC for mobile audio pickup and play
Reset Pin	When the GAC2500 is powered up, use a small pin to press the button one time to reboot. When powering up GAC2500, long press the button for 4 to 9 seconds to detect whether firmware file exists in USB OTG device to update system. When powering up GAC2500, long press the button for more than 10 seconds to quick restore factory settings.

GAC2500 Interfaces Explanations

Powering the GAC2500

The GAC2500 can be powered either using POE or PSU, please refer to the following picture to have more visibility how to connect your audio conferencing system.

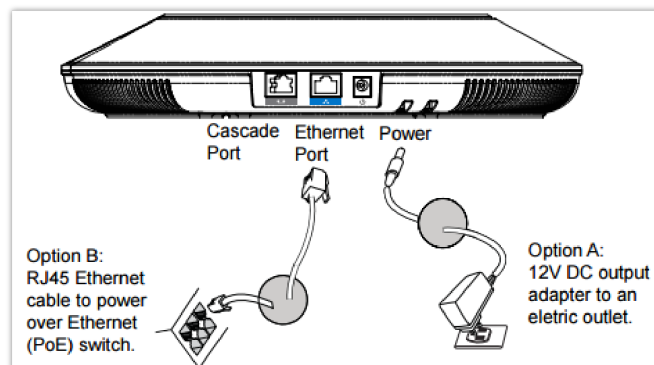

Powering the GAC2500

Connection Configuration

GAC2500 provides the following connection configurations:

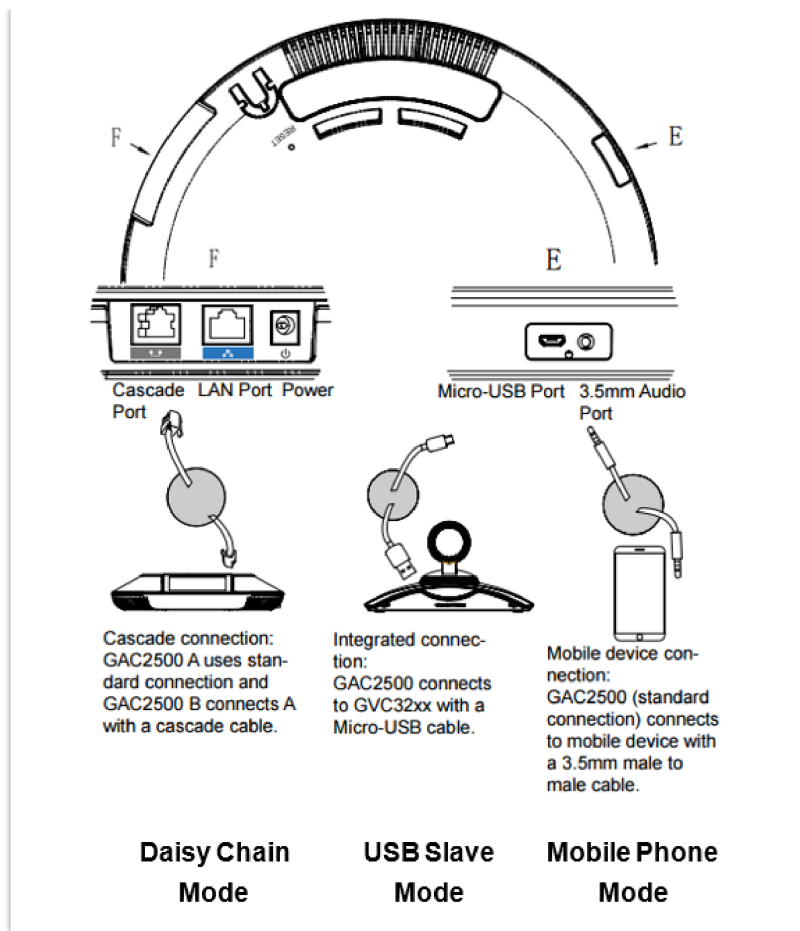

Connecting the GAC2500

IP Mode

The GAC2500 is used as an independent phone in IP mode. Please follow the steps below to connect.

1. Connect the LAN port of the device to the external network port (the port in the office or at home) via Ethernet cable;
2. Plug in the power adapter into the power supply interface then power up the GAC2500.

Note

It is recommended to use IP mode in room 3.6m* 7.2m or smaller.

USB Slave Mode

GAC2500 can be used as [auxiliary](#) device for GVC3200 or PC for audio acquisition and play. The conference feature will be disabled in USB slave mode. Follow the steps below to connect route.

1. Connect one end of the USB cable to the Micro USB port of the device and the other end to the USB port of GVC3200/PC;
2. Plug in the power adapter into the power supply interface then power up the GAC2500.

The GAC2500 screen is as shown below in USB slave mode.

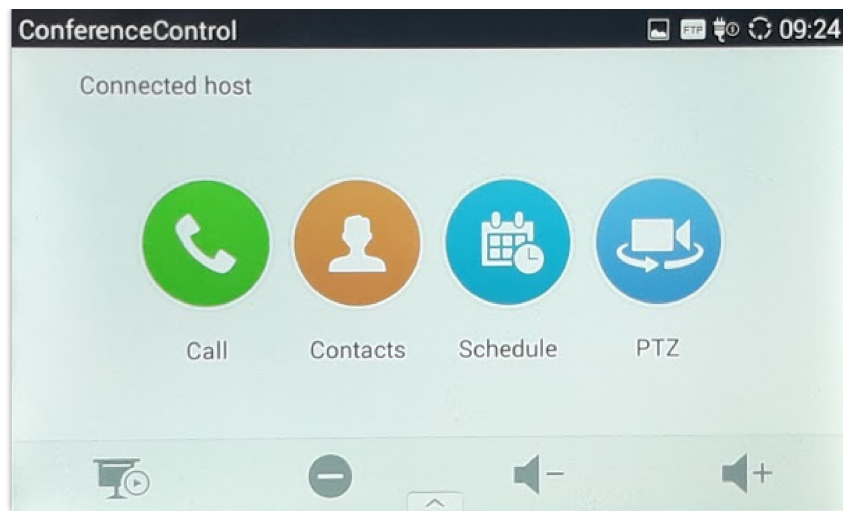

GAC2500 Slave Mode Screen

- o **Call**

Tap on the Call icon to see the GVC3200 call screen, users can make Audio/Video calls, share contents, Hold/UnHold, Record, Enable/Disable DND, and add more users to the conference.

- o **Contacts**

Tap on contact and a list of the GVC3200 will show up, users can search, make calls and sync with GVC3200 contacts if a new entry is added from the GVC3200.

- o **Schedule**

Tap on Schedule to view all the scheduled meeting from GVC3200.

- o **PTZ**

Tap on PTZ to access the GVC3200 PTZ settings, users could control PTZ movement in camera mode, set presets, zoom In/Out and adjust the focus.

If the GAC2500 is not connected to the SPKR USB interface it will prompt the following message in order to switch the port on the GVC3200.

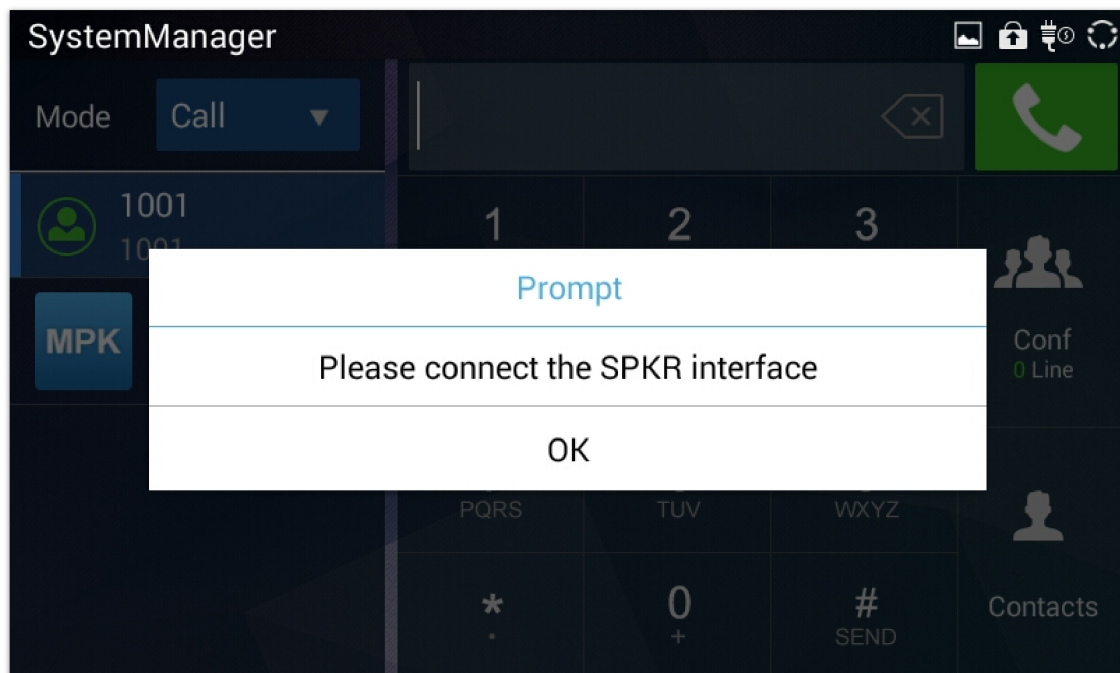

Connected to Wrong USB Port

Note

If GAC2500 is connecting to PC via Micro-USB but there is no audio output from GAC2500, it is because the PC uses default audio output in most cases. Please configure GAC2500 as default audio output.

Cascade Mode

Connect two GAC2500 (s) via RJ48 CAT5 for larger space. Please follow the steps below to connect.

1. Connect the LAN port of the device to the external network port (the port in the office or at home) via Ethernet cable;
2. Connect the RJ48 ports of two devices with RJ48 CAT5;
3. Plug in two power adapters into the power supply interfaces then power up two devices;
4. The screen is as shown below. Tap on "Yes" on the first device and set it to be the master while the other the slave.

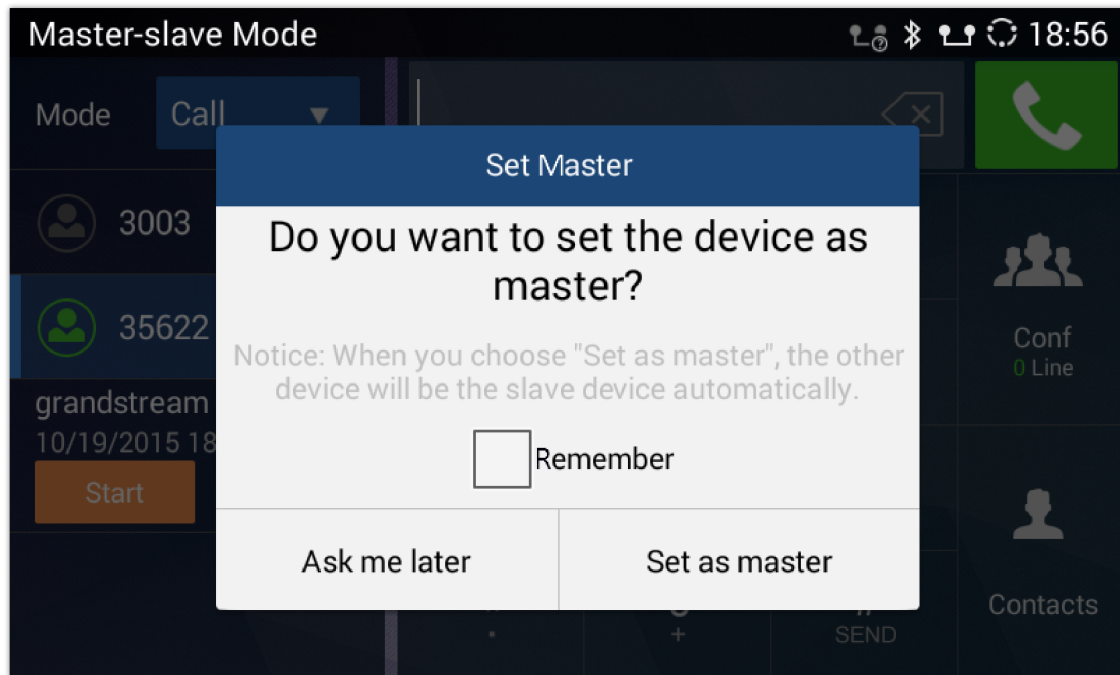

Figure 7: GAC2500 Cascade Mode Screen

Note

- It is recommended to use cascade mode in room 7.2m*12.2m or smaller.
- Please keep a distance of 5m between two devices.
- Please make sure the master device is connected to the network or it may not work properly.
- The slave device will synchronize with the master device and their dial screens will be shown synchronously.

Mobile Phone Mode

GAC2500 could be connected to mobile phone for expanded use. Please follow the steps to connect.

1. Connect the LAN port of the device to the external network port (the port in the office or at home) via Ethernet cable;
2. Plug in the power adapter into the power supply interface then power up the GAC2500;
3. Connect one end of the via 3.5mm audio aux cable to 3.5mm headset interface on the mobile phone first, then connect the other end to 3.5mm audio interface on GAC2500, once connected, it will access 3.5mm AUX call screen;

Note

If the audio quality is not good, it may be the line sequence issue, you can hold the screen at the top of the status bar, drag and drop down to open the status bar, tap on line sequence notifications and select the line sequence the same as the one of 3.5mm headset interface on the mobile phone.

4. When the mobile phone is answering an incoming call or dialing out, GAC2500 will collect and play the sound.

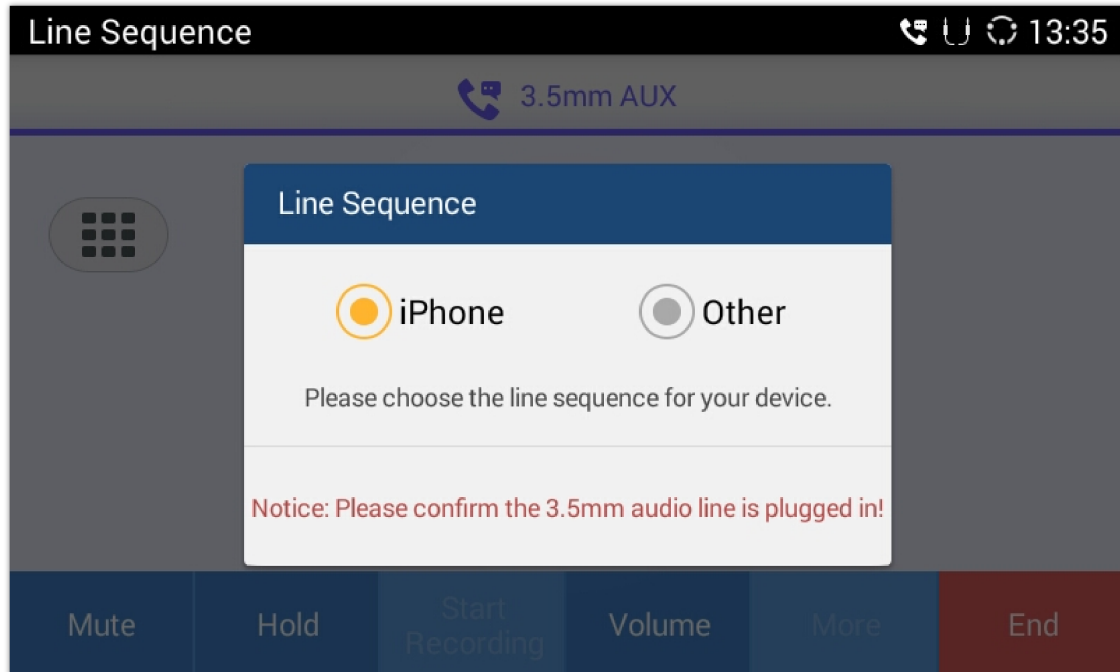

GAC2500 Select Line Sequence Screen

Note

- The GAC2500 package contains no 3.5mm audio aux cable, you can buy one at electronic gadgets store.
- The line sequence of GAC2500 must be the same as the one of your mobile phone, or the microphone may work improperly.
- It is recommended to connect mobile phone first, then GAC2500.
- You cannot dial or call a number via GAC2500 keypad directly.
- Once mobile phone mode is enabled, the 3.5mm audio aux line is regarded as one call line.
- Once a conference is established, the 3.5mm audio aux line is regarded as one party of the conference.
- Please do not unplug the 3.5mm audio aux cable or it may cause call exception.
- The audio quality may vary according to different types of 3.5mm audio aux cable and mobile phones.
- Once the 3.5mm male to male cable is inserted, some types of mobile phones may be detected by GAC2500 only after the call is established.

GETTING TO KNOW GAC2500

Desktop

When the GAC2500 is on idle screen, hold the screen at the bottom of the screen, drag upward to bring up 5 soft keys; hold the screen at the top of the status bar, drag and drop down to open the status bar,

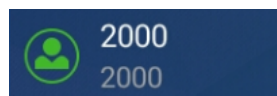

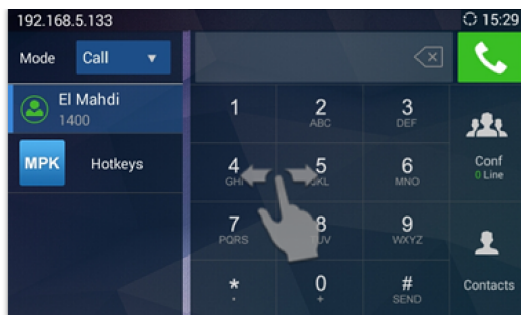















GAC2500 Multi-screens

- **Home Screen.** GAC2500 Home screen is a dial screen by default. You can dial up or start a conference on this screen. To change the home screen, please long press the blank area and select "Edit desktop". Press the  button in the preview desktop to set it as home screen.
- **Widget.** GAC2500 supports tools and Apps like Clock, MPK, and etc.
- **Status Bar.** The GAC2500 status bar is located on the top of the screen to indicate the current status of the device. Please refer to chapter **Status Icons** for more details.
- **Soft Keys.** 5 softkeys Including Volume+, Volume-, Back, Home, and Process Manager. Drag and slide upward at the bottom of the screen o bring out soft keys, the keys will be hidden automatically if no operation timeout.

Status Icons

Touch the status bar of GAC2500 and slowly drag it down to display the full status list. Users could view status icons that indicate the current status of the device. The following table lists the main status icons used on GAC2500.

Icon	Descriptions	Icon	Descriptions	Icon	Descriptions
	Ethernet is connected		Trying to connect to Ethernet		Ethernet is disconnected
	Missed call		One line is in active		Unread voicemail
	Calls from blacklist		Call forward is set up		Auto answer is set up
	DND mode is enabled		Wi-Fi is connected		Wi-Fi is enabled but not connected
	Bluetooth is connected		Sending files via Bluetooth		Bluetooth has been plugged in
	Using Bluetooth headset for calls		Volume is turned to silent		Mute is enabled.
	Downloading		Download failed		Updating Application
	3.5mm headset is inserted		Switch 3.5mm headset line sequence		Powering the device with PoE
	PPPoE is connected		PPPoE connection failed		Missed conference

	Warnings		New message		Full messages storage
	VPN is connected		VPN connection failed		More notifications
	The USB mouse is connected		The USB keyboard is connected		VPN is connected
	RJ48 CAT5 is connected		Set GAC2500 as master device		Set GAC2500 as slave device
	Hotspot is enabled		USB device is inserted		Full USB device storage

GAC2500 Status Icons Descriptions

Using the Onscreen Keyboard

Keyboard

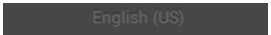
The default keyboard on the GAC2500 is English keyboard. The GAC2500 English keyboard supports multiple languages input methods. Users could tap on  to switch among different languages configured under LCD Menu Settings → Language & Keyboard → Keyboard & Input methods. See figure below.





GAC2500 Soft Keyboard – English Input Method

Tap on  to switch Caps Lock.



GAC2500 English Keyboard – Uppercase

Numbers and Symbols

To input numbers and symbols, tap on the default keyboard  to switch to numbers/symbols. Tap on  for more numbers/symbols.

Using the LED Indicator

The GAC2500 LED indicator is located on the top part of the device. It can be used to notify the users with current status of the device. The priority of the indicator from high to low is shown below.

Color	LED Indicator Status	Descriptions
Blue	Fast Flashing	Incoming call (including calls when conferencing and when phone is busy).
	Solid	Calling, Talking, Conferencing, Screensaver status.
	Slow Flashing	Call on hold.
Orange	Slow Flashing	Unhandled events. Including missed call (s), new voicemail (s), new SIP message (s).
	Solid	High memory usage, full message box, full contacts storage, network disconnection.
	Rapid Flashing	Upgrading.
None	OFF	Normal.

GAC2500 LED Indicator Descriptions

Note: The colors and statuses of LED indicators are by default. You can go to Web page→Maintenance→Device Manager to custom indicators.

ASSISTIVE TOUCH

Use the Touchscreen

To fully manipulate the GAC2500 capacitive touch screen, use your fingers to operate the following on the GAC2500 icons, buttons, menu items, onscreen keyboard and etc.

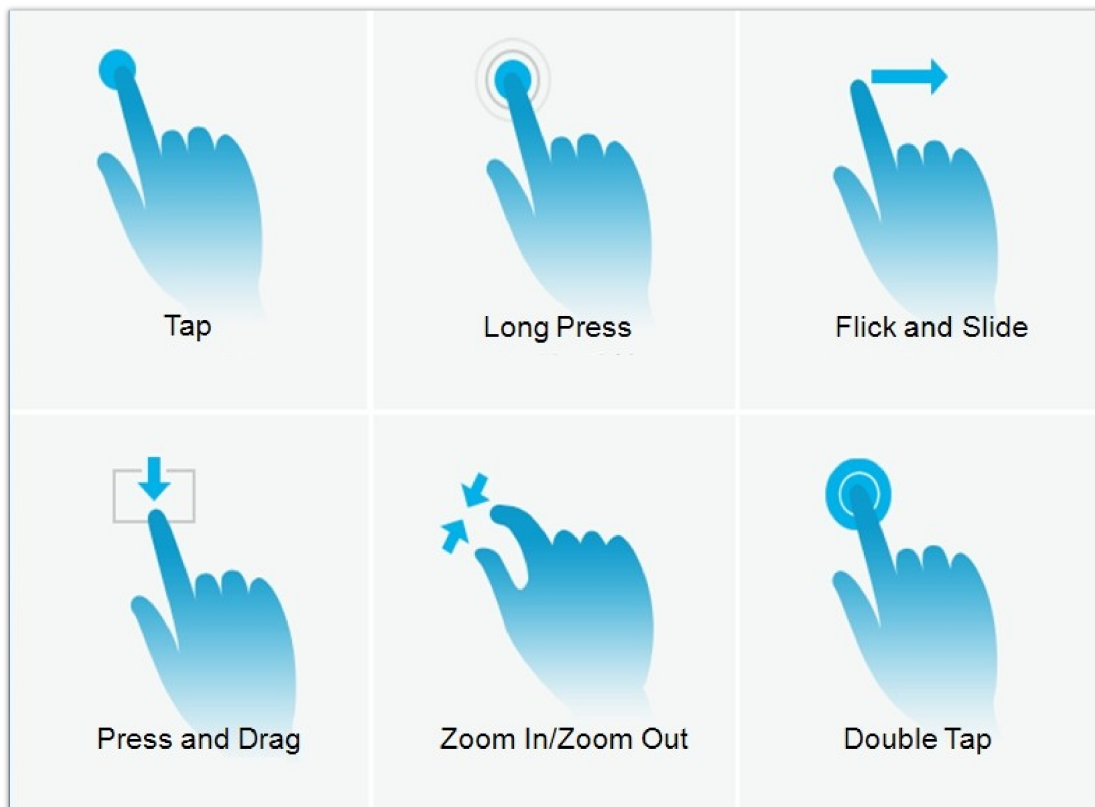

GAC2500 Finger Gestures on the Touch Screen

- Tap

Slightly touch the screen with fingertip to initiate menu, options or applications. For example, to select items on the screen (e.g., setting options, apps and etc.); to press onscreen buttons (e.g., "End" or "Options" soft key during the call); to type letters and symbols using the onscreen keyboard.

- **Long Press**

Touch the screen with fingertip and press for about 2 seconds without lifting your finger from the screen till an action occurs. For example, long press on a picture to bring up selection option.

- **Flick and Slide**

Touch the screen with fingertip and slide over the screen. For example, user could slide up to scroll up the page, slide down to open dropdown menu, slide left or slide right to delete an item from the list. If your finger stays on the screen for too long, the item may be selected and sliding won't occur.

- **Press and Drag**

Touch and press the item, then move it by dragging it up, down, left or right, without lifting your finger from the screen.

- **Zoom in/Zoom Out**

Place two fingers on the screen, then pinch them together (zoom out) or spread them apart (zoom in).

- **Double Tap**

Quickly touch the screen twice with fingertip to switch between default display and zoomed-in display. This is usually used when viewing photos or web pages.

Shortcut Keys

GAC2500 supports shortcuts for some special operation like Screenshots, Factory Reset, Upgrade and Security.

- **Screenshot.** Long press the Process Manager icon  on GAC2500 screen, the screenshot file will be saved automatically in the screenshot folder under SD card. Go to File Manager→Storage→Pictures→Screenshots to view files.
- **Factory Reset.** When powering up GAC2500, long press the reset button on the back of the device for more than 10 seconds to restore to factory settings.
- **Upgrade.** When powering up GAC2500, long press the button for 4 to 9 seconds to update system.

Managing Status Bar

The GAC2500 status bar is located on the top of the screen. Touch the bar and slowly drag it down to display the full status list. Once the status bar is opened, users could view Notifications.

The Notifications in the Status Bar is as shown in figure below.

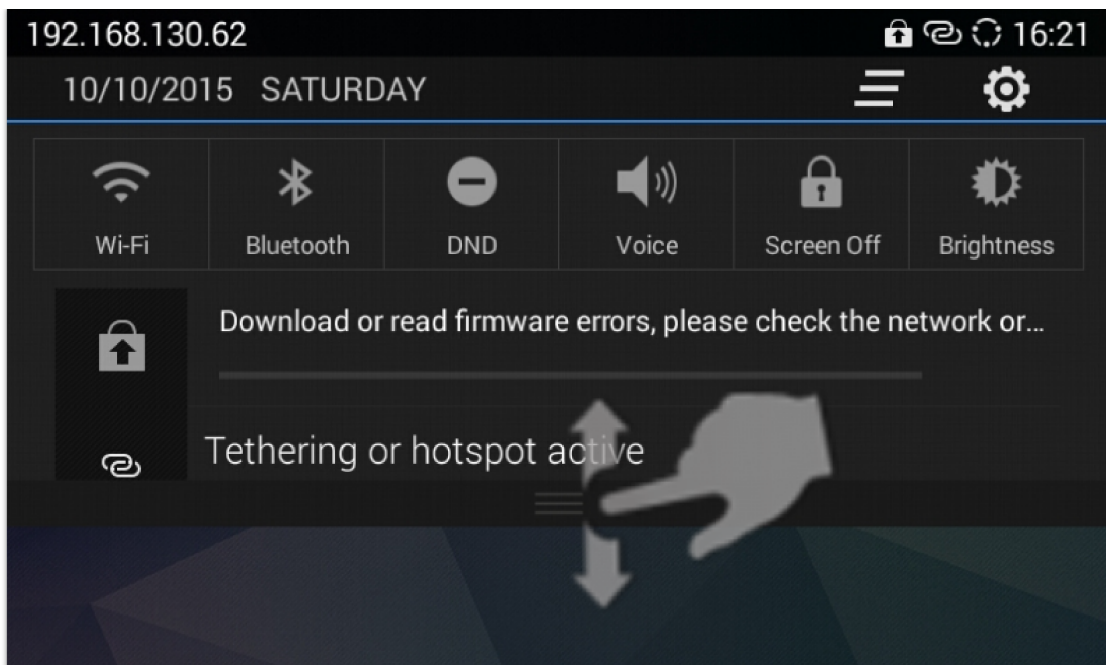

GAC2500 Status Bar – Notifications

Click on button  on the upper right corner to clear all notification messages.

- Slide a notification message to left or right to delete it.
- Click a notification message to view the details.
- Tap on the corresponding icon on the top of the screen to quick turn on/off the applications.
- Long press the corresponding icon on the top of the screen to quick access the applications.
- Drag the seek bar behind the icon  to adjust LCD brightness.

Desktop Menu

When the GAC2500 is on idle screen, long press the blank area, then you can tap on “Edit desktop” or “Set wallpaper”. See figure below.

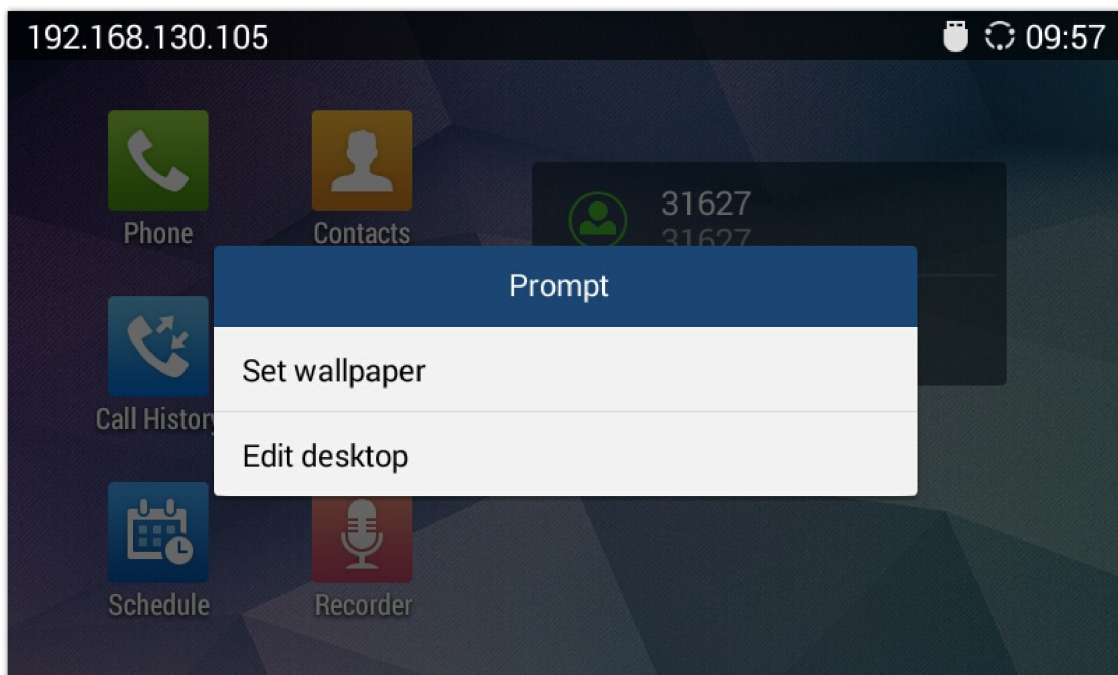

GAC2500 Idle Screen Menu

- **Edit Wallpaper:** Edit the idle screen wallpaper.
- **Edit Desktop:** Add, delete, edit desktop or add widgets on the desktop.

Edit Wallpaper

You can set wallpapers, live wallpapers or choose photo from gallery. See figure below.

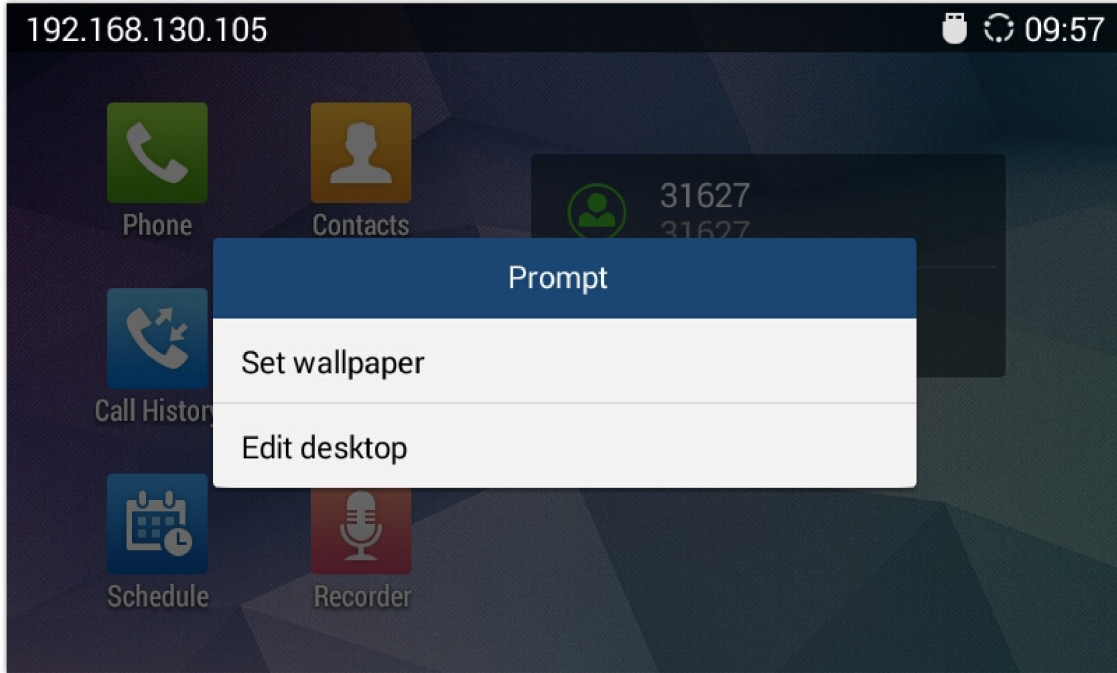

GAC2500 Choose Wallpaper

1. Long press the blank area on home screen then tap on "Set Wallpaper";
2. Slide wallpapers to left or right to view a list of sample wallpapers embedded in the GAC2500, tap on wallpaper to preview, tap on "Set Wallpaper" to confirm the selection. You can also select photo from gallery or file manager, or set live wallpapers.



Note: The user has the ability to block image gallery options using GUI Customization Tool 3.9.0. The GUI Customization Tool can be found under the link: <http://www.grandstream.com/support/tools> .

Edit Desktop

The desktop screen is as shown below.



GAC2500 Edit Desktop

- Add Desktop: Press finger slightly in free space of the screen and fast slide to the last screen and click  on the middle screen to add a new desktop. Users could add up to 15 desktops.
- Delete Desktop: Click  on the upper right corner of the blank desktop to delete it. The desktop with widgets and shortcuts on it is undeletable.
- Tap on the  icon of a preview desktop to set it as home screen.

Adding an Item to Desktop

Users could add commonly used items (Weather Forecast, RSS News, etc.) to the desktop. Follow the steps below:

1. When the GAC2500 is running on idle screen, long press the blank area, then tap on "Edit Desktop";
2. Slide left or right to view a list of options;
3. Press and drag the shortcut or widget you would like to add and drag it to the desktop you want to put on.

Notes

- Please ensure that there is enough space on the desktop when adding widget.
- Users may need to select the specific items before adding them to the desktop. i.e., browser, bookmark, star-labeled contact, photos, etc.

Managing Desktop Apps and Items

All the GAC2500 apps/items can be accessed /removed. Take Weather Forecast as an example in the following chapter.

○ Opening an app

Tap on Weather Forecast icon to access screen as shown on the following figure. Users could edit Weather Forecast after accessing it.



GAC2500 Weather Forecast Screen

○ Moving an app

Touch and hold the Weather Forecast icon, when the icon begins to float, drag it to any desktop with free space.

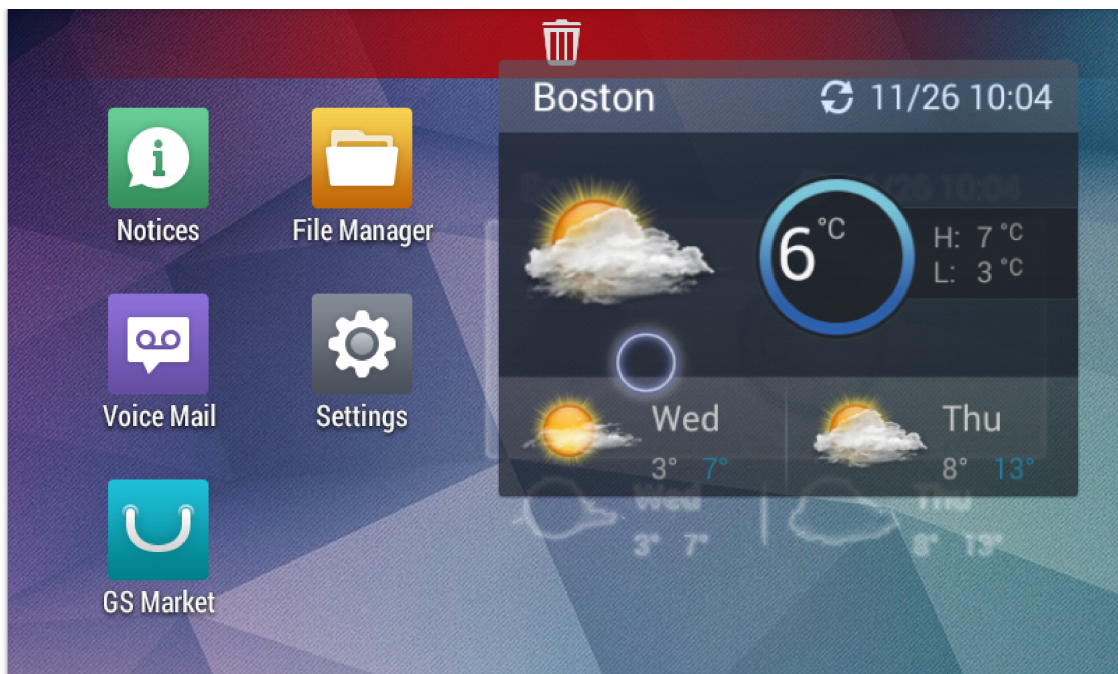

GAC2500 Move Weather Forecast to Desktop

o **Removing an App**

Touch and hold the Weather Forecast icon until the Recycle Bin  icon displayed on the top as shown in figure 18, drag the widget to the Recycle Bin, when the item gets close to the Recycle Bin, it will turn red. Now release your finger to delete.

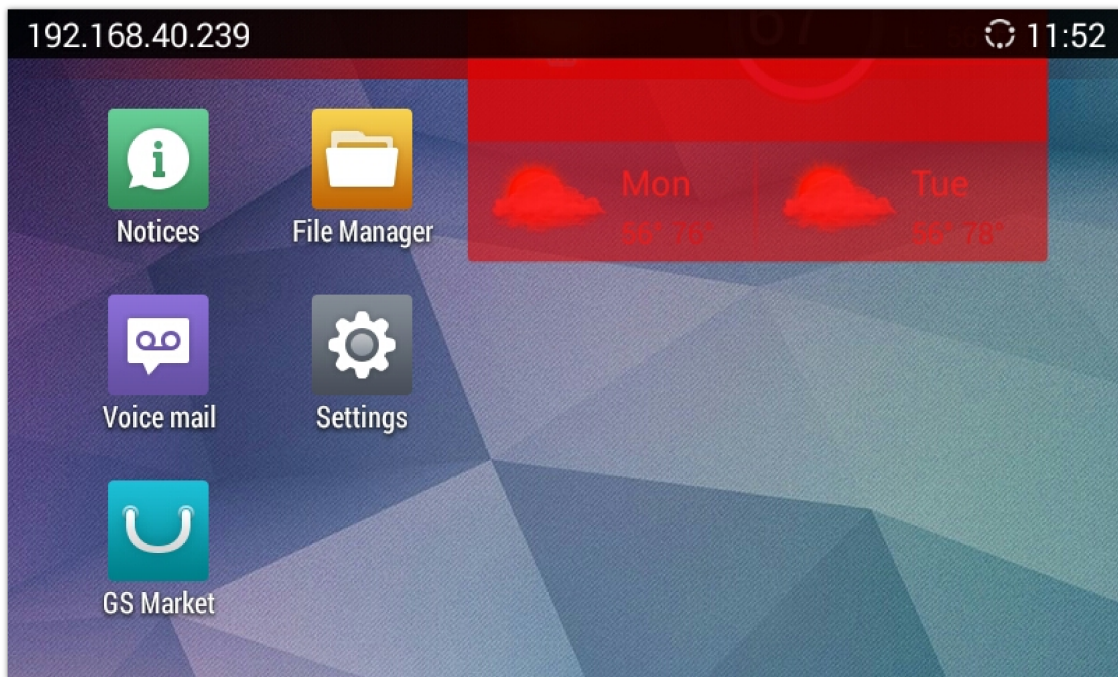

GAC2500 Remove Weather Forecast from Desktop

Note

The system applications cannot be deleted.

Managing Applications

Tap on the Process Manager icon  on screen to view the running applications on the GAC2500 as shown below.

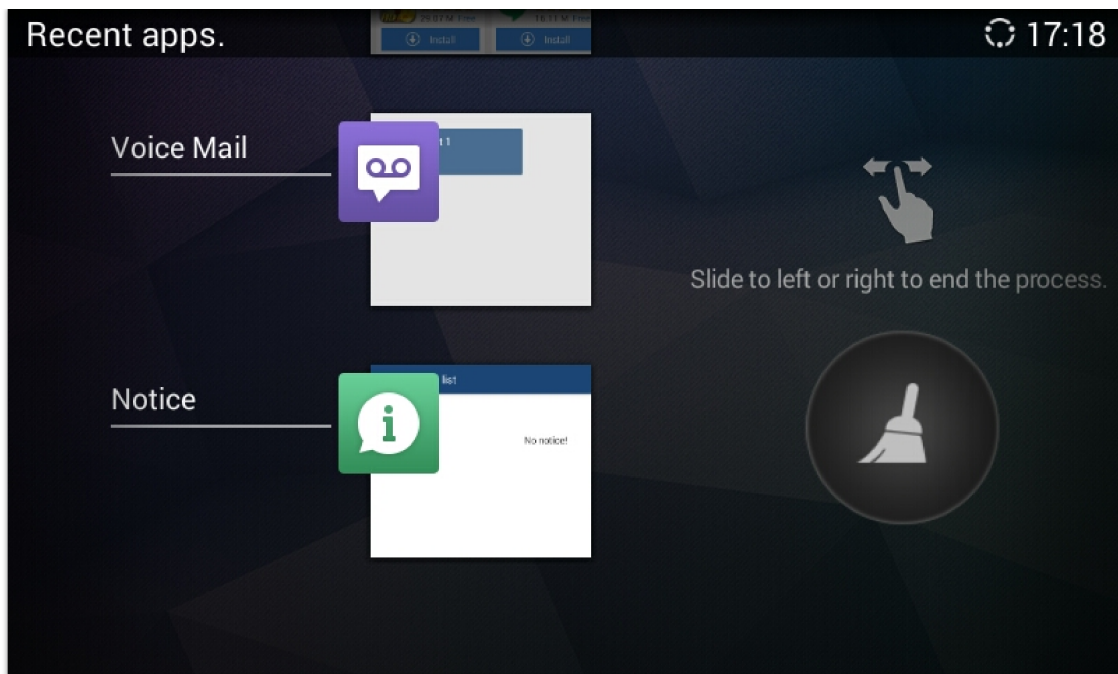

GAC2500 Managing Applications

Slide up/down to view the applications, tap on one and slide left/right to turn it off, or tap on it to access the corresponding interface. Tap on to turn off all running applications.

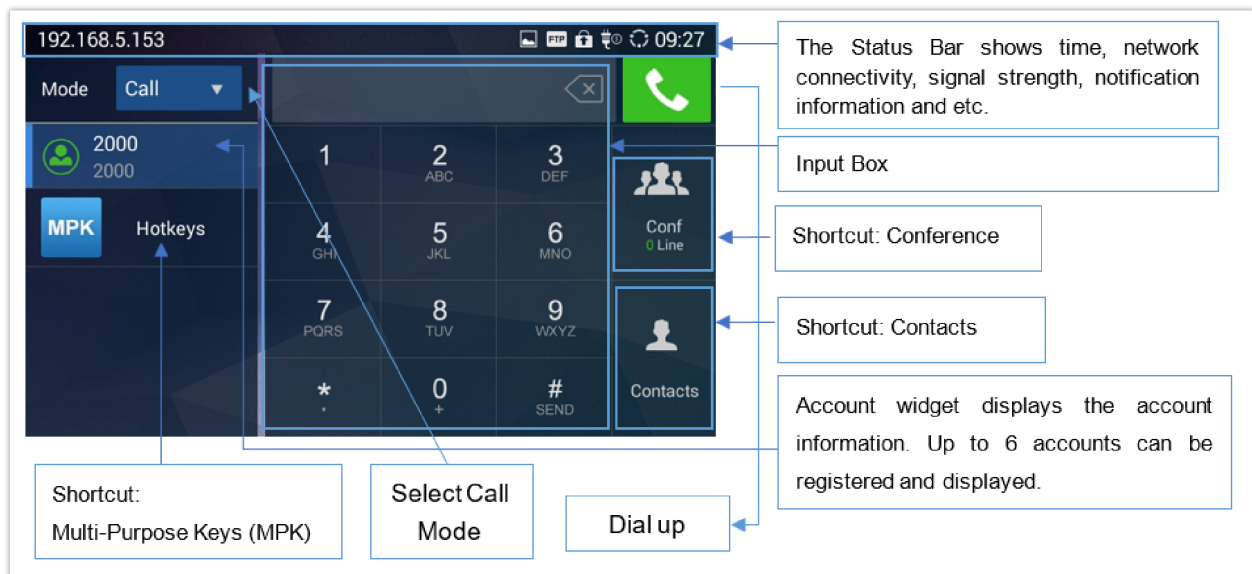

GAC2500 Home Screen

- **Mode.** Set the call mode.
- **Account.** Display all registered accounts. Tap to select account.
- **Input box.** Tap on digits below to input phone number, or tap on the input box to bring out the soft keyboard. You will see all the matching numbers on the left when you are inputting digits, tap on the number to add it to input box directly, you can add up to 6 numbers.
- **Dial-up.** Tap to dial out.
- **Conference.** Display the conference line. Tap to access conference interface.
- **Contacts.** Tap to access Contacts interface to add more contacts to the input box.
- **Hotkeys.** This is a quick access to MPK app.

You can slide left or right to the Conference app on other desktops, or dial out multiple numbers to start a conference on home screen.

CONNECTING TO NETWORK AND DEVICES

The GAC2500 supports a variety of network connections (Ethernet, Wi-Fi) and device connections, you can configure on GAC2500 or log in the GAC2500 web UI to configure. For more information about using web UI, please refer to the GAC2500 Administration Guide in www.grandstream.com.

Network

Network connection has a variety of ways, one is wired connection via the cables, and the other way is to connect via Wi-Fi.

Ethernet

If the user would like to use Ethernet connection for network access, please connect the Ethernet cable to the LAN port of the GAC2500. Ethernet connection is turned on as DHCP by default.

To configure Ethernet settings on GAC2500:

1. Plug the Ethernet cable into the LAN port on the back of the GAC2500.
2. Go to LCD menu→Settings→Advanced settings → Wireless & network → Ethernet → IPv4 Settings.
3. Tap on "Address Type" to select DHCP, Static IP or PPPoE as the address type.
 - For DHCP, save the setting and the GAC2500 should be able to get IP address from the DHCP server in the network.
 - For static IP, enter IP Address, Subnet Mask, Default Gateway, DNS Server and Alternative DNS server for the GAC2500 to correctly connect to the network.
 - For PPPoE, enter PPPoE account ID and password so the GAC2500 can get IP address from the PPPoE server.

WI-FI

Turning Wi-Fi On or Off

Wi-Fi is supported and built-in on the GAC2500. On the LCD display, go to Settings→Advanced settings→Wireless & network → Wi-Fi to turn on and configure Wi-Fi.

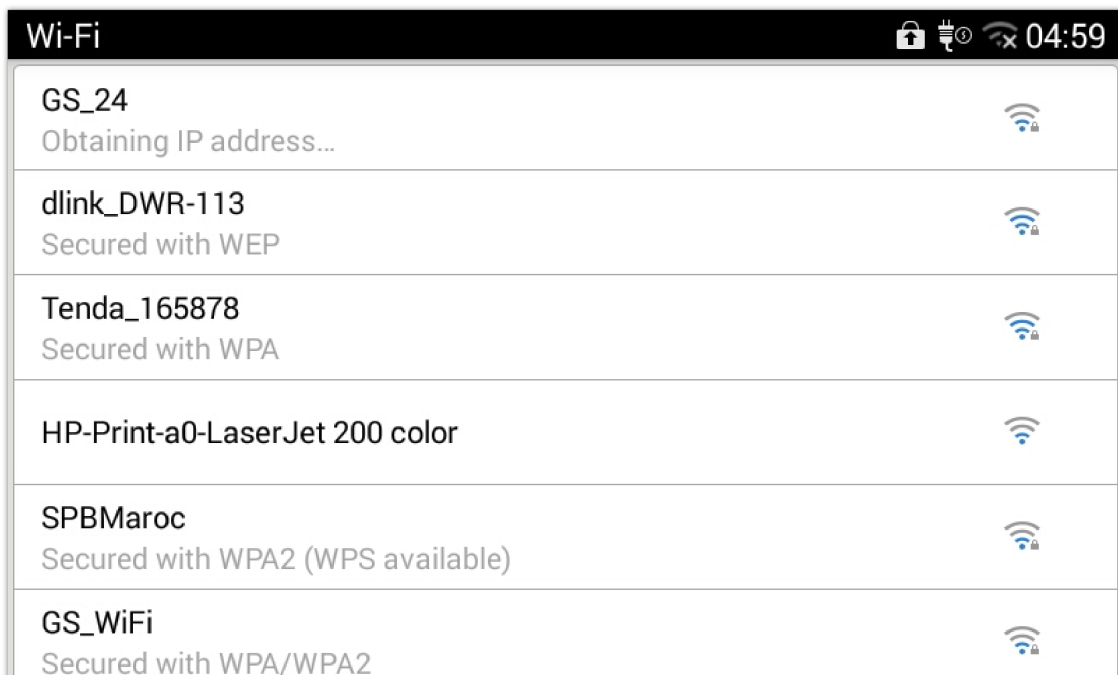

GAC2500 Add Wi-Fi Screen

Search and Add Wi-Fi

Once Wi-Fi is turned on, GAC2500 will automatically start the scanning within the range. A list of Wi-Fi networks will be displayed as scanning result. Tap on the SSID and enter the correct password information to connect to the selected Wi-Fi network.

Follow the steps below for static IP usage in Wi-Fi environment:

1. Tap on one Wi-Fi network in the scanned Wi-Fi list to bring up the dialog that shows signal strength, security, password and option "Show advanced options".
2. Select "Show advanced options". The dialog will show additional option "IP settings".
3. In "IP settings", select Static IP, enter IP Address, Subnet Mask, and Default Gateway for the GAC2500 to correctly connect to the network.

Bluetooth

Users could use the Bluetooth to send or receive files to cellphone, or use Bluetooth speaker and etc.

Turning Bluetooth On or Off

There are two ways to enable Bluetooth:

- On the LCD display device, go to Settings→Network→Bluetooth.
- Click  to enable the Bluetooth in the drop-down status bar.

Pairing GAC2500 with a Bluetooth Device

Before connecting GAC2500 with other Bluetooth device, users must pair them first. They will stay paired afterwards unless they are manually unpaired. To pair Bluetooth device:

1. On the LCD display device, go to Settings→Bluetooth. Switch the "Bluetooth" option.
2. Select "Bluetooth settings", drag up from LCD bottom and press  button on the remote control and select "Search for devices".
3. The GAC2500 scans and displays the IDs of all available Bluetooth devices in range. Once the Bluetooth device shows up in the result, tap on it to start pairing.
4. Confirm the passkey in the prompted message (if any). Or if passcode is required, please refer to the device's documentation or other procedures to obtain the passcode.

Connecting to a Bluetooth Device

After successfully paired, the device will be connected to the GAC2500 immediately. Users will see this device listed under "Paired Devices". Tap on  next to the connected device. Users will see options "Rename", "Unpair" and etc.

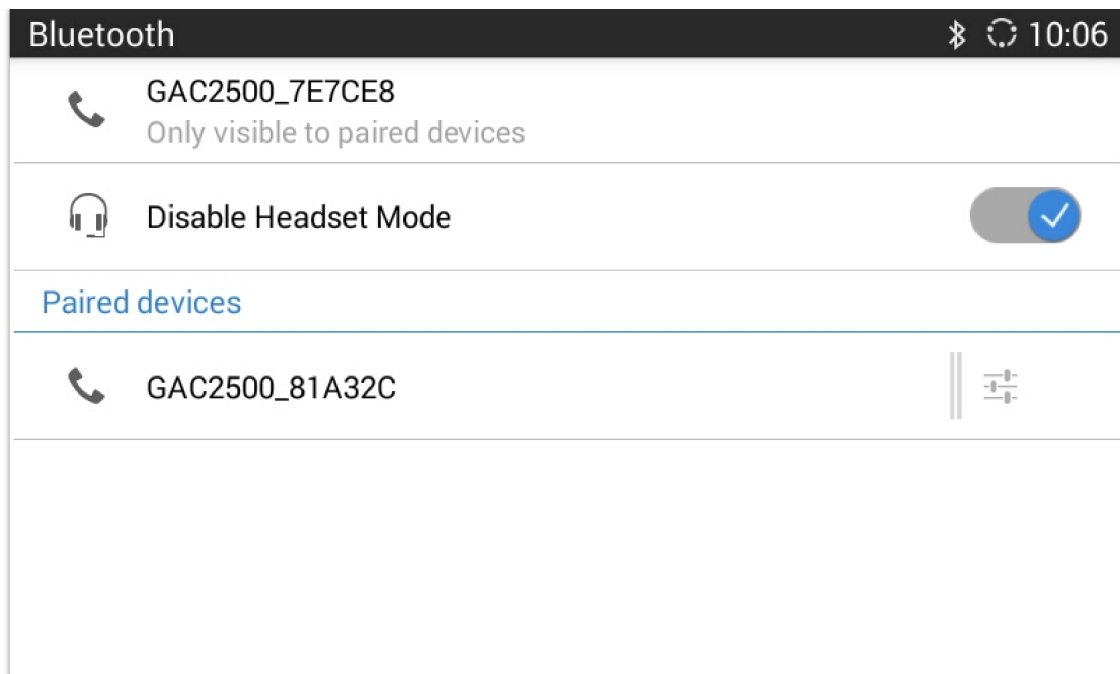

GAC2500 Bluetooth – Paired Device

If the connection is lost between the Bluetooth device and GAC2500, go to LCD menu → Settings → Bluetooth → Bluetooth setting and click on the device name under “Paired devices” again to reconnect.

When enabled headset mode, the connected Bluetooth device could use GAC2500 as a headset audio device. You can see the Bluetooth device is displayed as an account on the left home screen. You can make dial-ups with this account directly, or as a party to join conference.

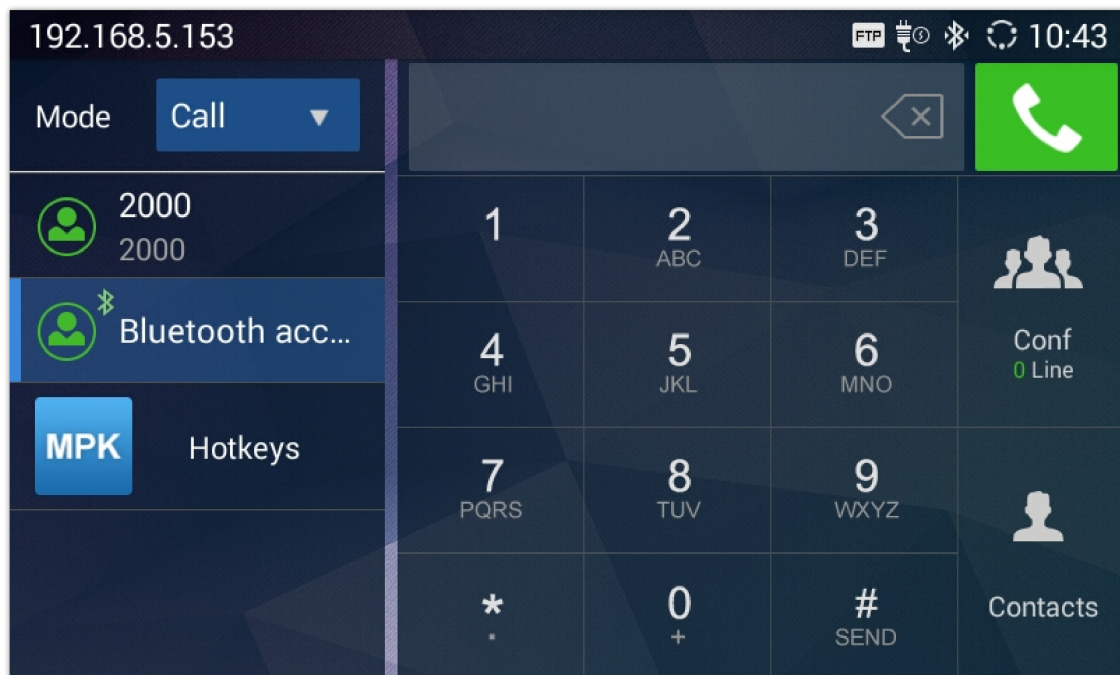

GAC2500 Bluetooth – Headset Mode

Note

- When enabled Bluetooth headset mode, a pop-up dialog will prompt to remind users whether import contact or call history from Bluetooth device (your phone), if agree, when you input digits in input box, the device will automatically start contact/call history matching.
- When enabled Bluetooth headset mode, when your Bluetooth device has an incoming call, GAC2500 also rings and displays call screen at the same time. You can either answer the call with your Bluetooth device or GAC2500.
- When enabled Bluetooth headset mode, you can switch audio channels freely on your Bluetooth device.
- please note when enabled Bluetooth headset mode, making calls with Bluetooth account is actually with your device and it may generate flow/communication fees, GAC2500 only serves as a Bluetooth headset to transmit and control audio.

Sending Files via Bluetooth

Users could transfer files, share contacts information from other Bluetooth portable devices to GAC2500 after pairing and connection. A prompt for file transferring will be displayed on GAC2500 LCD display device when the GAC2500 receives the file transferring request. Accept the request to receive file and the file will be stored under SD Card/Bluetooth directory.

VPN Settings

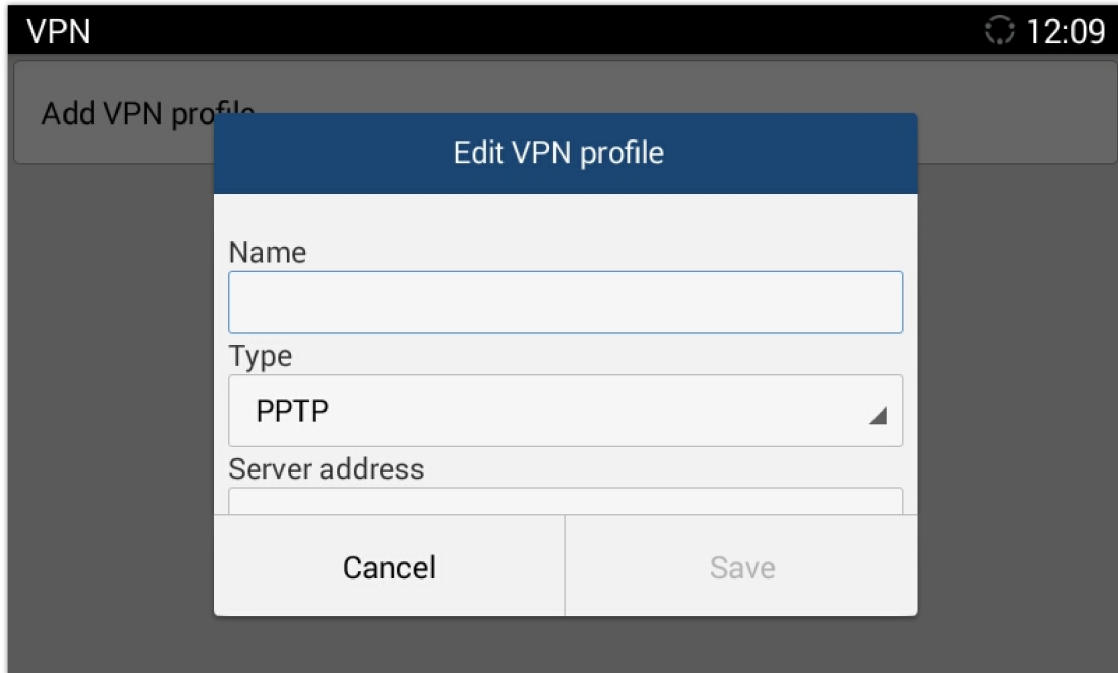

Users can add VPN using different protocols. Follow the steps below to set up VPN.

1. On the LCD display device, go to Settings → **Advanced settings** → **Wireless & network** → **VPN**.
2. Tap on "Add VPN file" to access configuration page as shown below;



GAC2500 Add VPN Files Screen

1. Fill in parameters and save, go back to VPN page, you will find the new VPN file you just added;
2. Tap on the VPN file to open the validation page, fill in correct username and password to connect to VPN.

If the GAC2500 is connected to VPN successfully, icon  will be shown in the top status bar; if the connection is failed, a prompt box will pop up to remind users whether to connect again. If icon  displays in the top status bar, please check whether your VPN configuration is correct.

Parameters	Descriptions
Layer 2 QoS 802.1q/VLAN Tag	Assigns the VLAN Tag of the Layer 2 QoS packets for LAN port. Default value is 0. Note: Please do not change the setting before understanding the VLAN's settings or consulting the network administrator. Otherwise, the device might not be able to get the correct IP address.
Layer 2 QoS 802.1p Priority	Assigns the priority value of the Layer 2 QoS packets. Default value is 0.

GAC2500 VLAN Configuration Parameters

LLDP Settings

Access GAC2500 home screen, go to **Settings** → **Advanced settings** → **Wireless & network** → **Additional network settings** to configure LLDP settings on the GAC2500.

Parameters	Descriptions
LLDP	Enable or disable LLDP. The default setting is disabled.
Layer 3 QoS for SIP	This field defines the layer 3 QoS parameter for SIP packets. It is the value used for IP Precedence, Diff-Serv or MPLS. The Default value is 48.
Layer 3 QoS for Audio	This field defines the layer 3 QoS parameter for audio packets. It is the value used for IP Precedence, Diff-Serv or MPLS. The Default value is 48.
LLDP TX Interval(s)	Configures the interval the phone sends LLDP-MED packet, the default setting is 30s.

GAC2500 LLDP Configuration Parameters

802.1x Mode

Access GAC2500 home screen, go to **Settings**→**Advanced settings**→**Wireless & network**→**Additional network settings**→**802.1X Mode**. By default, 802.1X is disabled. Select 802.1X mode to "EAP-MD5", "EAP-TLS5" or "EAP-PEAP" to turn on 802.1X. Once 802.1X mode is enabled, the user will be required to enter the identity and Password to be authenticated in the network.

Parameters	Descriptions
802.1x Mode	Allows the user to enable/disable 802.1X and configure 802.1X mode. The default setting is disabled.
Identity	Enter the Identity information for the 802.1X mode.
MD5 Password	Enter the MD5 Password for the 802.1X mode.
CA Certificate	Upload the CA certificate for the 802.1X mode.
Client Certificate	Upload the CA certificate for the 802.1X mode.
Private Key	Upload the private key for the 802.1X mode.

GAC2500 802.1X Mode Parameters

MAKING PHONE CALLS

Account

GAC2500 supports up to 6 independent SIP account and 1 BlueJeans™ account. Users need to register their own accounts to the SIP server to make calls via the accounts.

The following figure shows the account is successfully registered (account icon is highlighted in green).

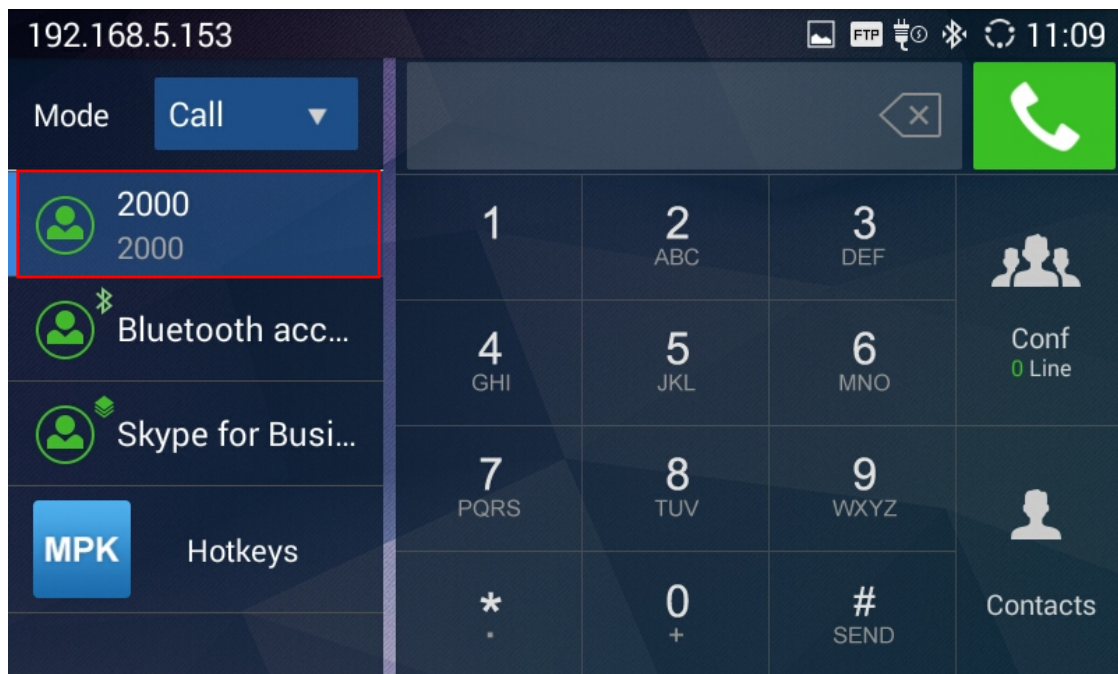



GAC2500 Registered Account Statu

The GAC2500 supports also using dial pad to dial out call in Skype for business app.

Making a Call

Direct Dialing

GAC2500 home screen is the dial screen or you can tap on  on desktop to access dial screen.

1. Enter the dial screen, select account and call mode;
2. Enter the necessary digits on the keypad;
3. Tap on  to dial out.

Note

1. GAC2500 allows users to configure the “#” key as the “Send” key. If users need to cancel this setting, please log in the built-in Web page to set the parameter “use # as the dial key” to “No”.
2. Enter digits in the dial-up box. If the digits or the letters for the digit matches contacts and call history, a dropdown list of numbers will be displayed. For example, entering 5 (JKL), 6 (MNO), 4 (GHI) and 6 (MNO) will display 5646 or john if contact “john” exists. Users can then select it to dial out.
3. Users do not need to change call mode to “IP call” to make a IP call. Dial the full IP such as 192*168*124*123#5062 would make the call. But quick IP call still needs “IP call” selected.
4. If input area has a number, the GAC2500 will check the account call settings to see if “Use # as Dial Key” is enabled or not.
5. If input area has no number, DUT will use ‘#’ as redial directly.

Redial is to dial the last dialed-out number. It is only available when the call log exists.

1. Enter the dial screen;
2. Press the button  or tap on “#” to dial the last dialed-out number automatically.

Note

You can redial the last dialed-out number, but unable to dial the conference.

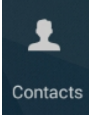

Dialing a Number via Contact

Follow the steps below to dial from dial pad Contacts.



1. Click on the Contacts  on the down right of dial pad.

2. Input the number.



3. Tap on the dial key  to dial out.



Or, check the  for more than one contact, then tap on  on the up right to start a conference.

Follow the steps below to dial a number via Contacts app.



1. On the LCD display device, access Contacts by tapping on the icon  on LCD.
2. Navigate and select in the Contacts entries using the remote control navigation keys.
3. Tap on the dial key  to dial out.

Dialing a Number via Call History

1. On the LCD display device, access Applications on home screen and access call history by selecting icon .
2. The LCD will display all call history types. Navigate in the call history list by selecting the call history category. Select the call history entry you would like to dial out.
3. Press  to dial out.

Or, check the  for more than one contact, then tap on  on the up right to start a conference.

Follow the steps below to dial a number via Contacts app.

1. On the LCD display device, access Contacts by tapping on the icon  on LCD.
2. Navigate and select in the Contacts entries using the remote control navigation keys.
3. Tap on the dial key  to dial out.

Direct IP Call

Direct IP Call allows GAC2500 and another VoIP device to talk to each other in an ad-hoc fashion without a SIP proxy. VoIP calls can be made between these two if:

- Both GAC2500 and VoIP phone have public IP addresses

Or

- Both GAC2500 and VoIP phone are on the same LAN / VPN using private or public IP addresses

Or

- NAT is disabled in network or GAC2500 NAT is disabled for the account.

Both devices can be connected through a router using public or private IP addresses (with necessary port forwarding or DMZ).

To make a direct IP call, please follow the steps below:

1. Access the dial screen on GAC2500;

2. Set the mode to "IP Call";
3. Input the target IP address. For example, if the target IP address is 192.168.124.123 and the port is 5062, input the following:

192*168*124*123#5062

The * key represents the dot (.) and the # key represents the colon (:).

4. Press  to dial out.

Notes

- In dial pad, default call mode also supports IP call by dialing IP address. GAC2500 would analyze the input and make IP calls.
- Default call mode does not support quick IP call. If you want to make quick IP call, please change the call mode to "IP call".

Paging/Intercom

Before placing paging/intercom, please make sure the callee has paging/intercom enabled so it can automatically answer the paging/intercom call. To make paging/intercom call:

1. Access the dial screen on GAC2500;
2. Set the mode to "Paging";
3. Enter the number to dial;
4. Press  to dial out.

Answering a Call

When the device is in idle and there is an incoming call, the device will show the call screen as below.

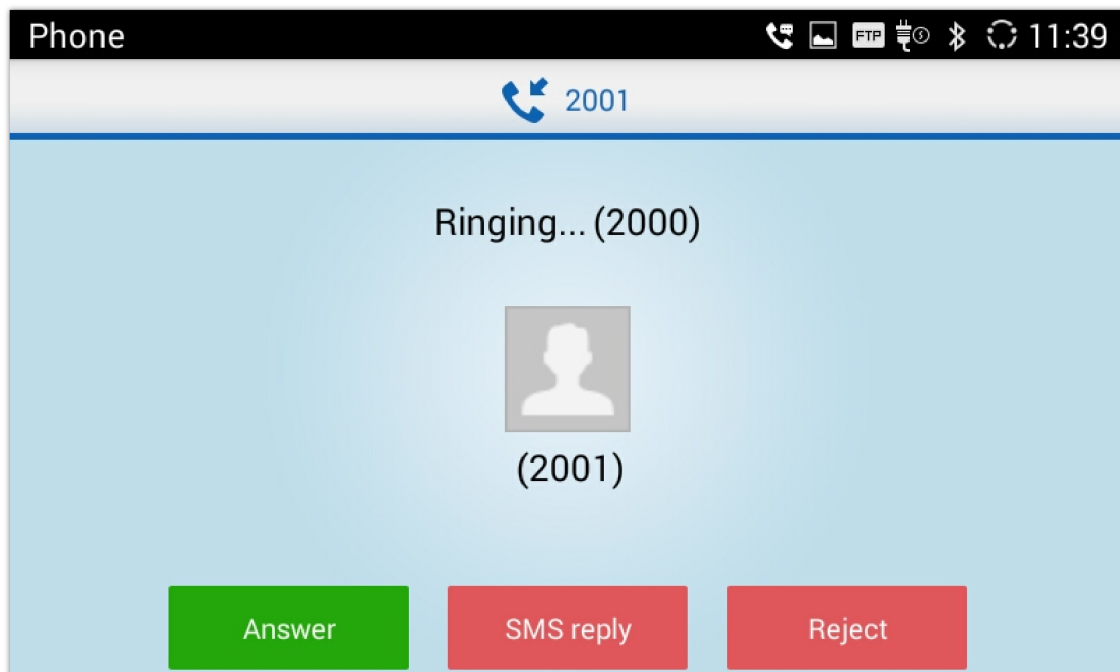

GAC2500 Single Incoming Call Screen

Select "Answer" to answer the call, or reject the call by pressing the "Reject" soft key.

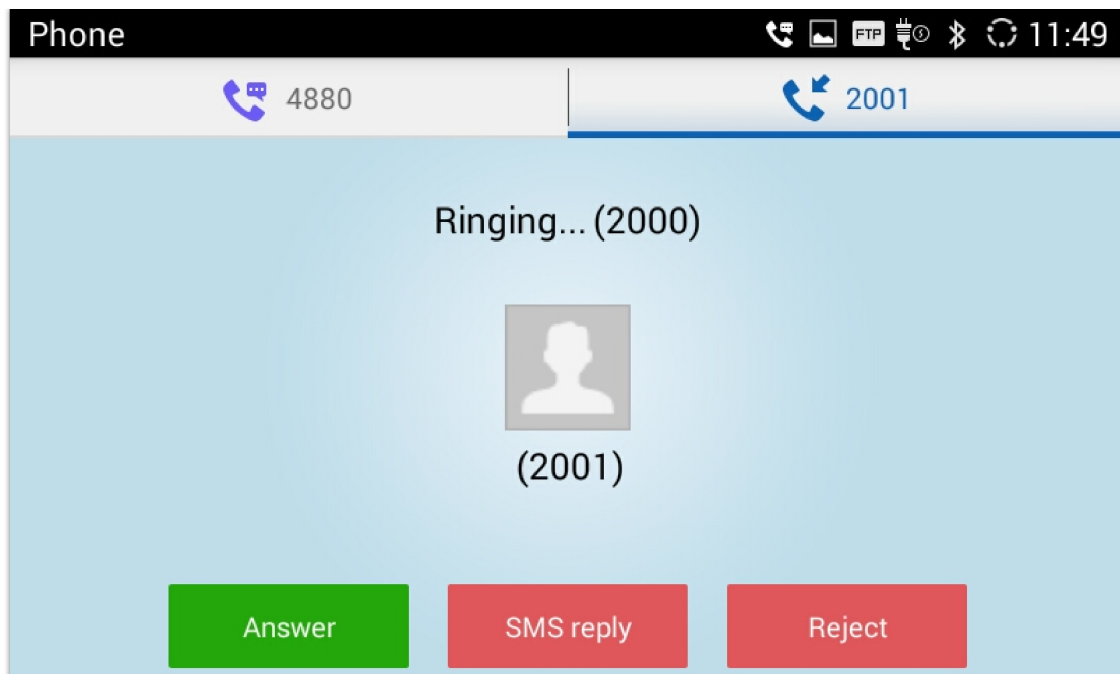

When there is an incoming call during an active call, users will hear a call waiting tone with the LCD displaying the caller name and ID for the incoming call.



GAC2500 New Incoming Call Screen

Users could select "Answer" to answer with audio only, or eject the call by pressing the "Reject" soft key.

Reject Call via SMS

Users could reject incoming calls via messages. Please access Notices application  on desktop and tap on Settings  on the upper right corner, and enable "Enable Quick Reply". You can also tap on  below to custom your reply.

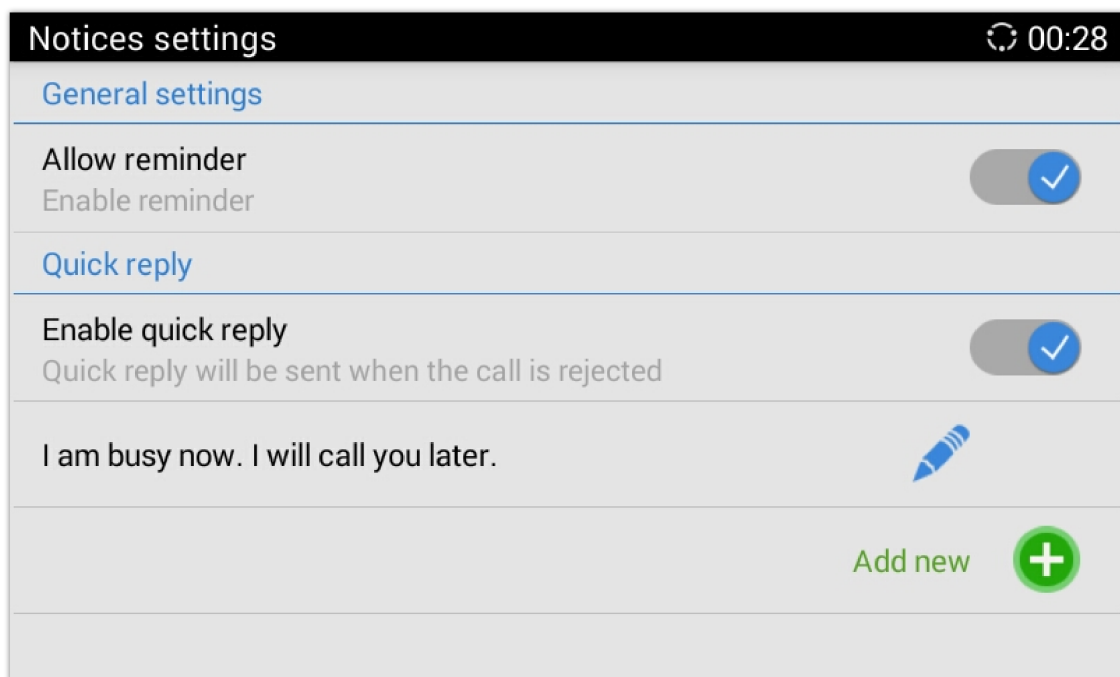

Reject Call via SMS

Once enabled "Enable quick reply", when there is an incoming call, you can tap on "SMS reply" to access quick reply list, select the reply to send the reject call.

Note

Notices reject function works when the callee sends the SIP message to the caller to reject call, please confirm your service provider supports this service.

Call Management

During an active call, you can make other operations like hold/hold, mute/unmute, call recording, add a new call, start conference, or end the call.

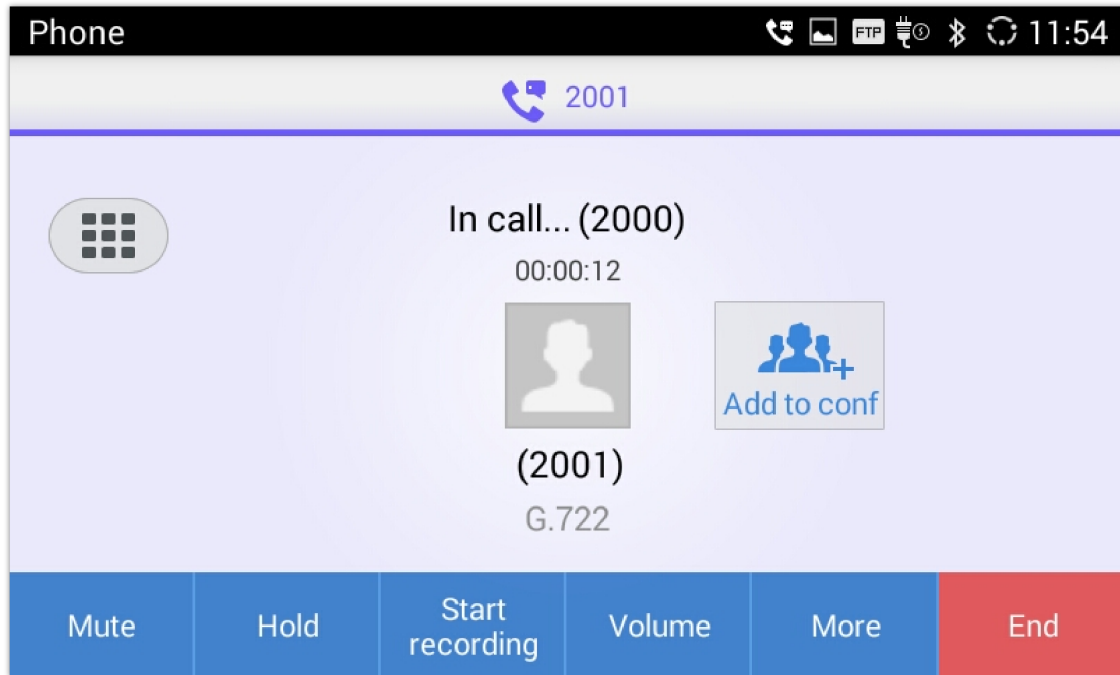

GAC2500 Single Calling Screen

- **Call Lines:** Display the current line status: active, hold, incoming, outgoing.
- **Add to Conf:** Tap to add all active lines to conference members.
- **Mute/Unmute:** Tap to mute/unmute the call.
- **Hold/UnHold:** Tap to hold/hold the call.
- **Start/Stop recording:** Tap to start/stop recording.
- **Volume:** Tap to bring up the volume bar to adjust the volume, The 3.5mm interface is mainly used for placing a cellphone in a conference. So, the volume range differs from cellphones. Please adjust the volume on the cellphone if it is too high.
- **More:** Bring up more options including like MPK, Transfer, etc.
- **DTMP Keypad:** Tap to bring up the DTMF keypad.
- **End:** End the current line.

Call Hold and Call Resume

- **Call Hold**

During the active call, press HOLD  button to put the current call on hold. Users could then make or answer a new call. It shows as follows:

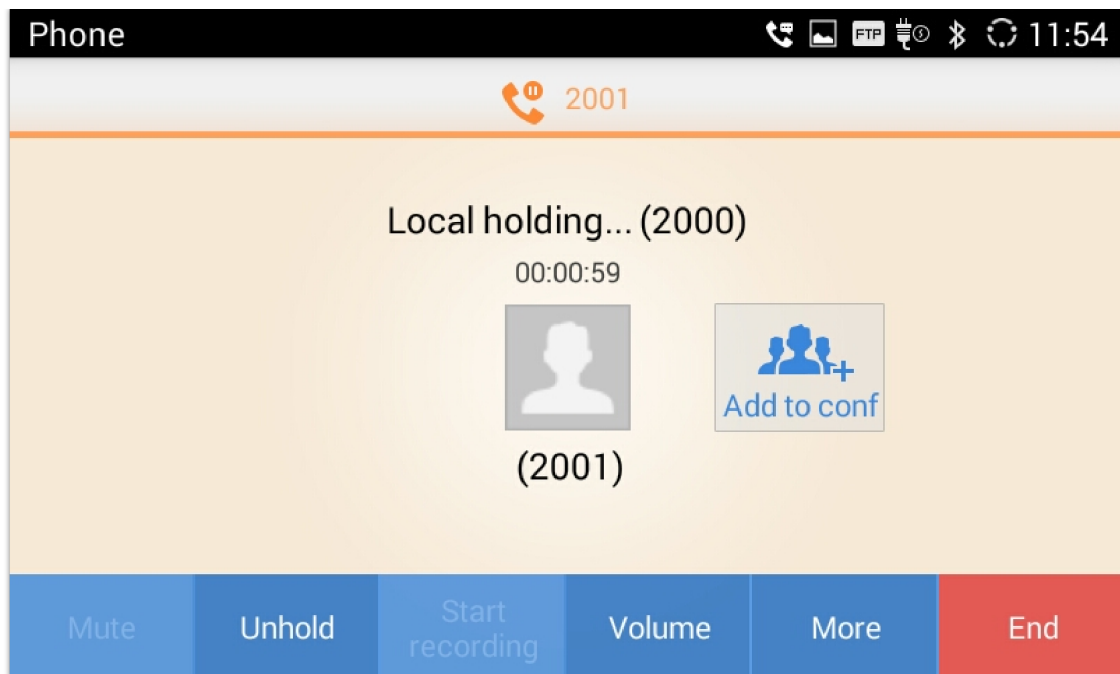

GAC2500 Call On Hold Screen

o **Resume to Call**

If the active call is on hold, users could press the “UnHold” button to resume call or tap on the “End” button to hang up the call.

Call Record

Users could save the call conversations to the GAC2500 by recording during an active call. You can listen to the recordings from Recorder, please refer to the chapter Recorder for details.

1. During an active call, tap on the “Start Recording” soft key in the bottom to start recording as shown in the figure below:
2. Tap on the Stop Recoding soft key to stop recording.

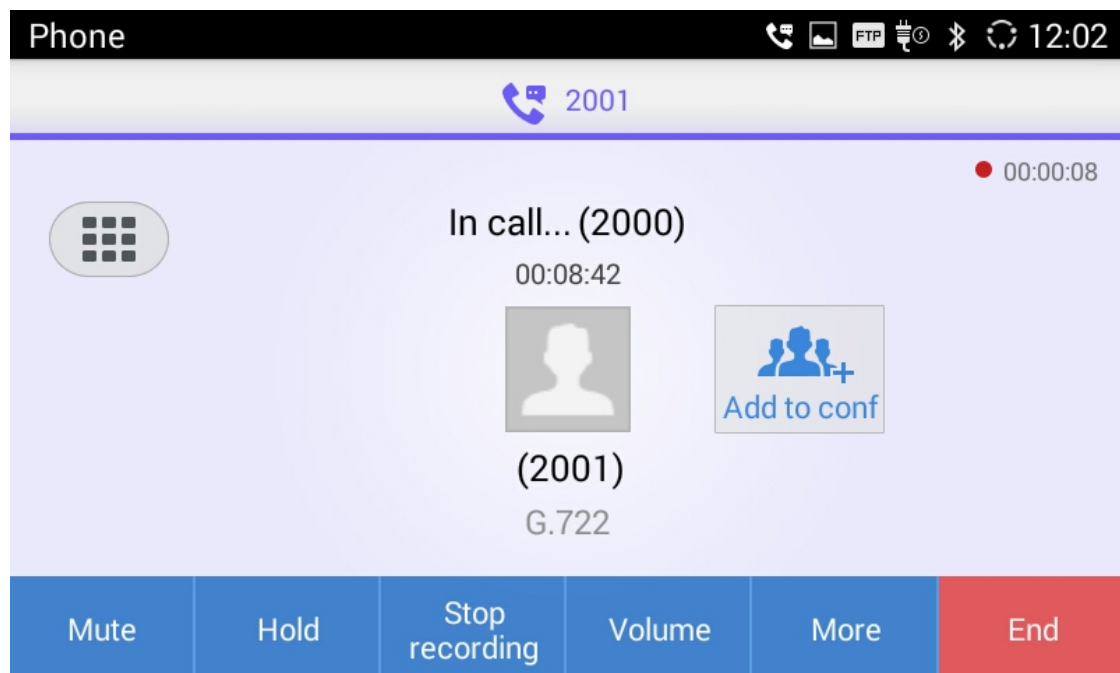

GAC2500 Mew – Start Recording

Call Details

Users could view the call details of the GAC2500 during an active call by following steps below:

1. During an active call, tap on the "More" soft key in the bottom to show more options as shown in the figure below:

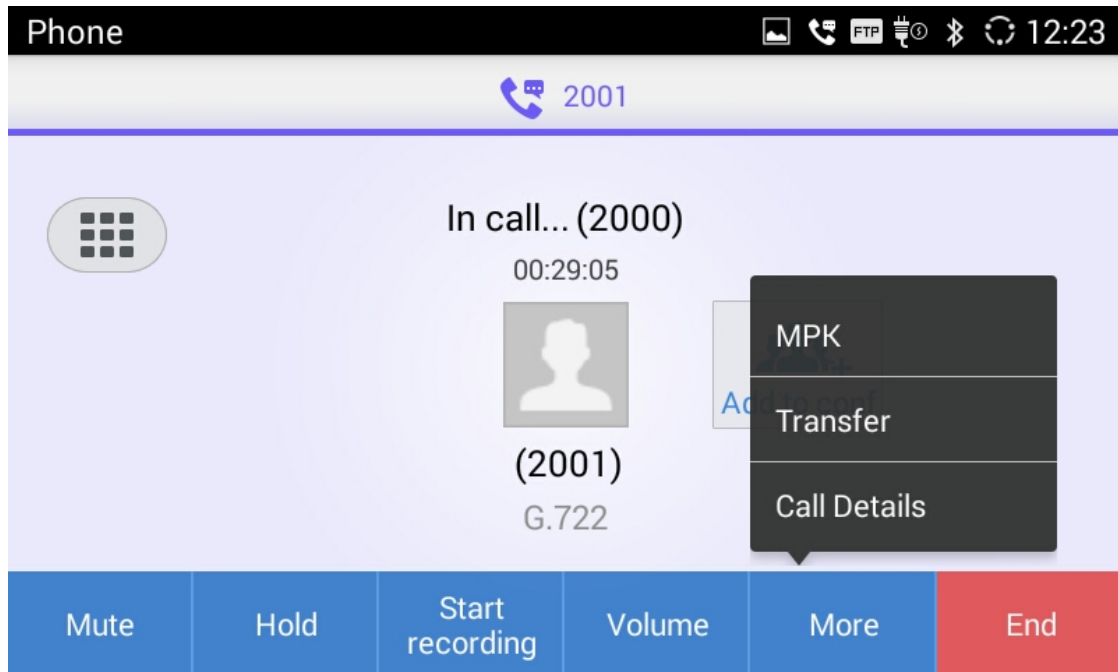

More softkey

2. Tap on the "Call Details" soft key to show the call details.

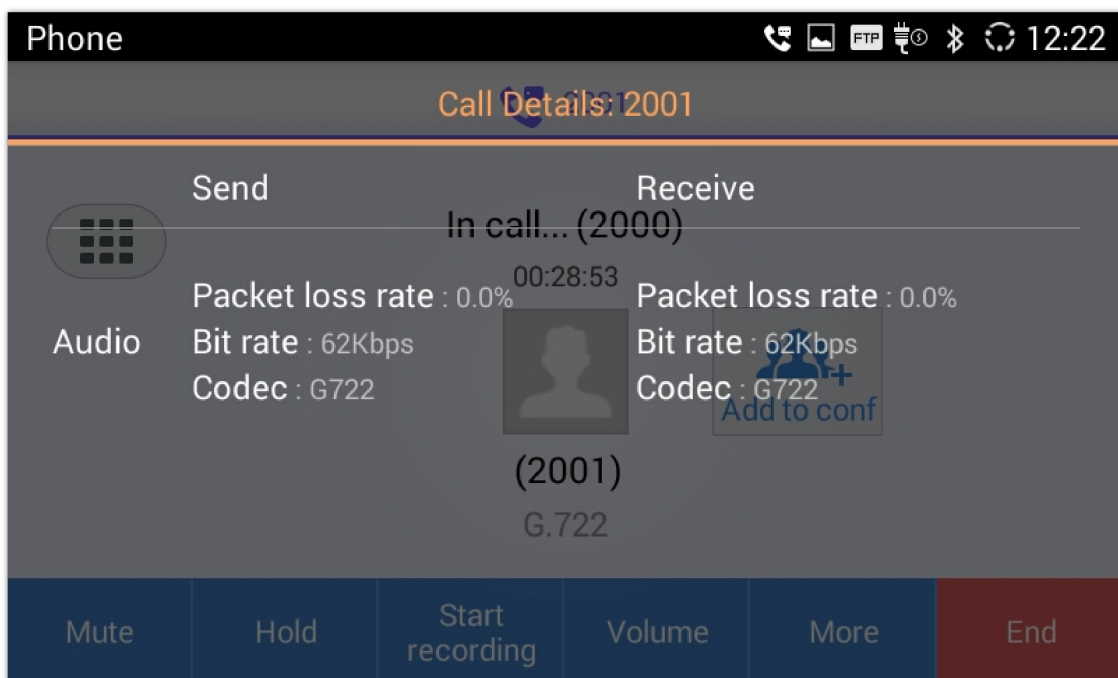

Call Details

Mute

During the active call, you can tap on the "Mute" button to mute the call, you will not be heard by others. The screen is as shown below.

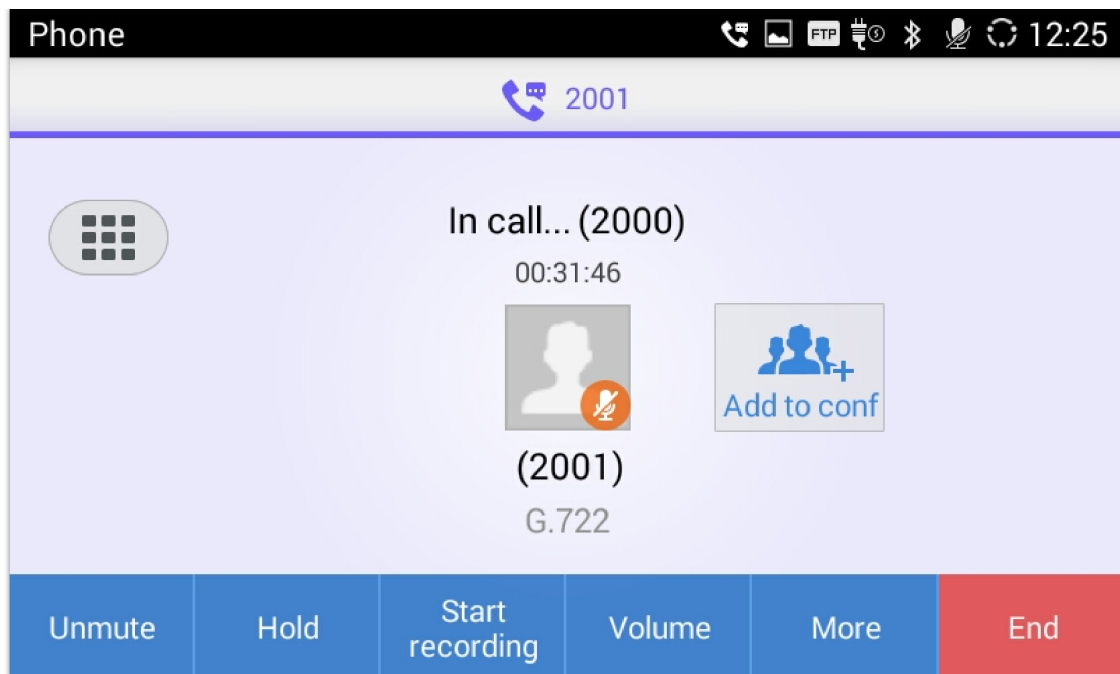

GAC2500 Mute Call Screen

Call Transfer

is a telecommunications mechanism that enables a user to relocate an existing telephone call to another phone or attendant console, call transfer including blind transfer and attended transfer according to different situations, for example, if user A wants to transfer the call with user B to user C, blind transfer or attended transfer is optional.

Blind Transfer

1. User A and user B are in an active call.
2. User A tap on Transfer button to bring up the transfer screen;
3. Set the transfer mode to Blind. The default mode is Blind;
4. Enter the digits and press the SEND to transfer the call with user B to User C. When user C's phone rings, the phone interface of user A is shown in figure 32. If user C answers the call, user A will automatically go back to the idle screen, which indicates the successful transfer;
5. User C's phone will ring, the phone with CID function will display user B's number on screen as the caller.

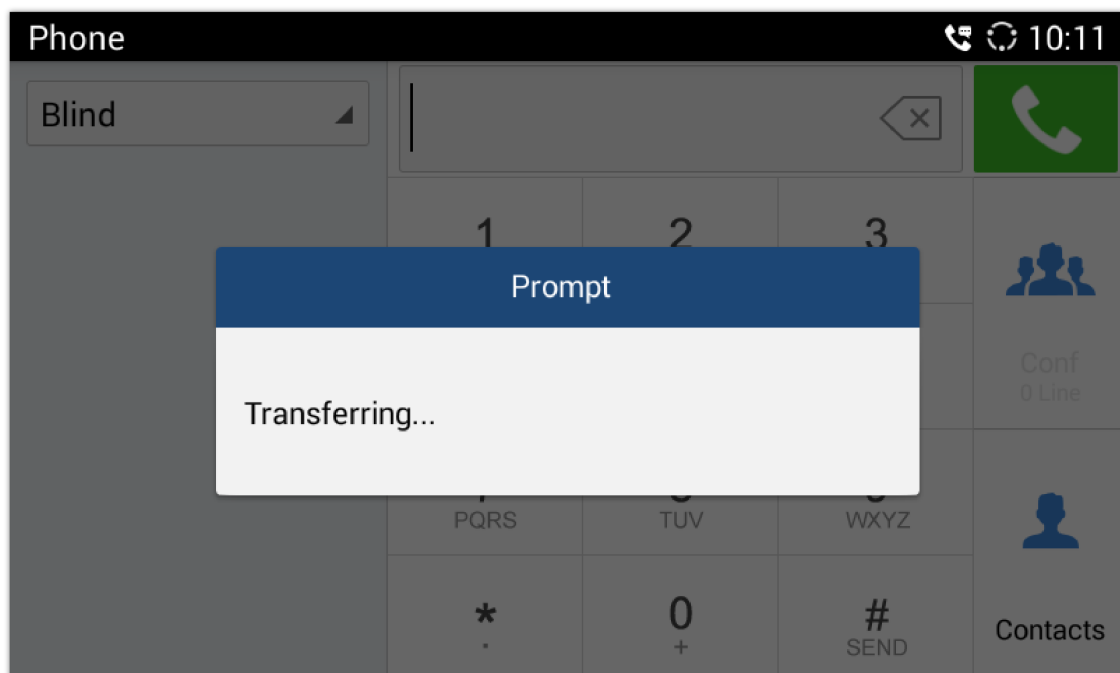

GAC2500 Transfer – Blind Transfer

Note

- If inputted the wrong digits, press the button  to delete the digit one by one, or long press the button to empty all digits.
- Users could drag up the bottom of LCD and tap on Back icon to go back to the active call interface if wants to cancel transfer.
- The result of step 4 and 5 may differ because of SIP servers. The result described below is based on Grandstream SIP server.

Attended Transfer

There are two ways of attended transfer: Call Forward and Call Transfer.

◦ CALL TRANSFER

1. User A and user B are in an active call;
2. User A presses the button  to add a new line with user C. The call with user B will be automatically put on hold;
3. User C answers the phone to set up the line with user A; User A taps on More button in the menu then choose Transfer to bring up the transfer screen. The line with user B will be displayed on screen;
4. User A sets the transfer mode to Attended then choose to display user B's number, the call will be transferred to user C. User B and user C could talk directly via the phone.

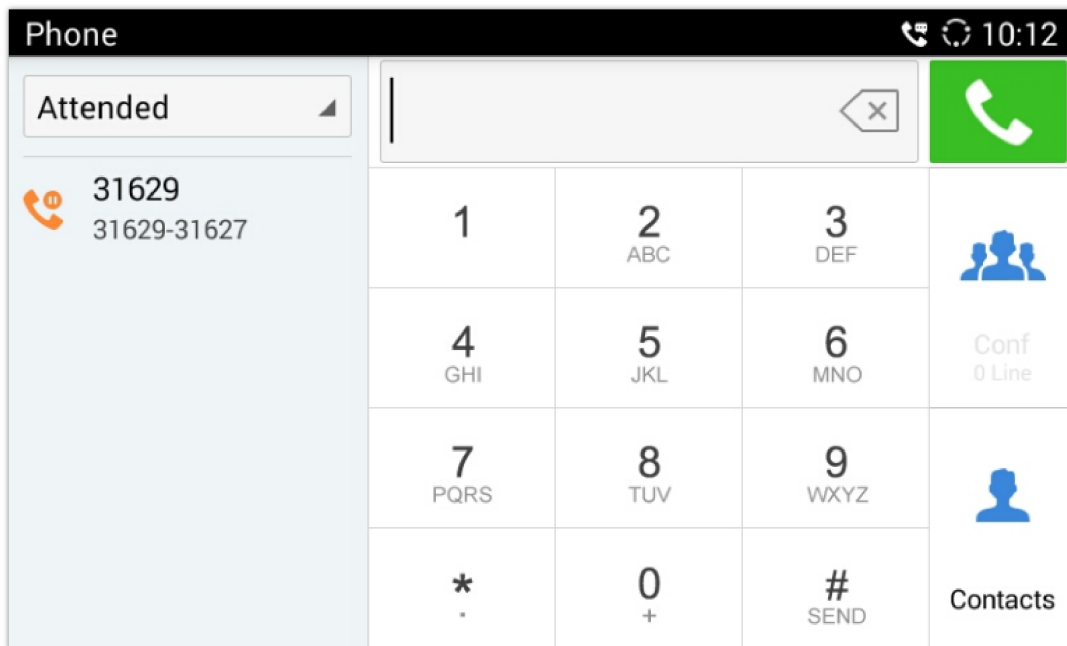

GAC2500 Transfer – Attended Transfer

Note

When receiving Incoming call which has been transferred to the GAC, the device will indicate that by displaying the message "Transferred from" as shown on the screen below.

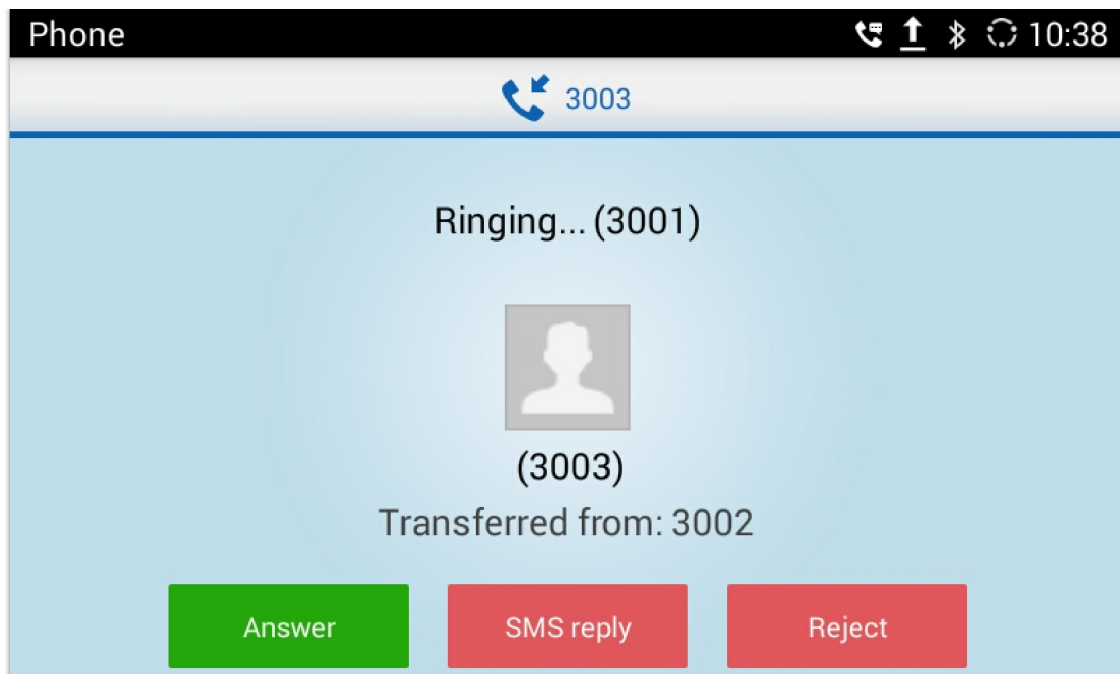

Incoming Transferred call notification

o **CALL FORWARD**

1. User A and user B are in an active call. User A tap on More button in the menu to choose Transfer to bring up the transfer screen;
2. Select the Transfer mode. As shown in figure 34;

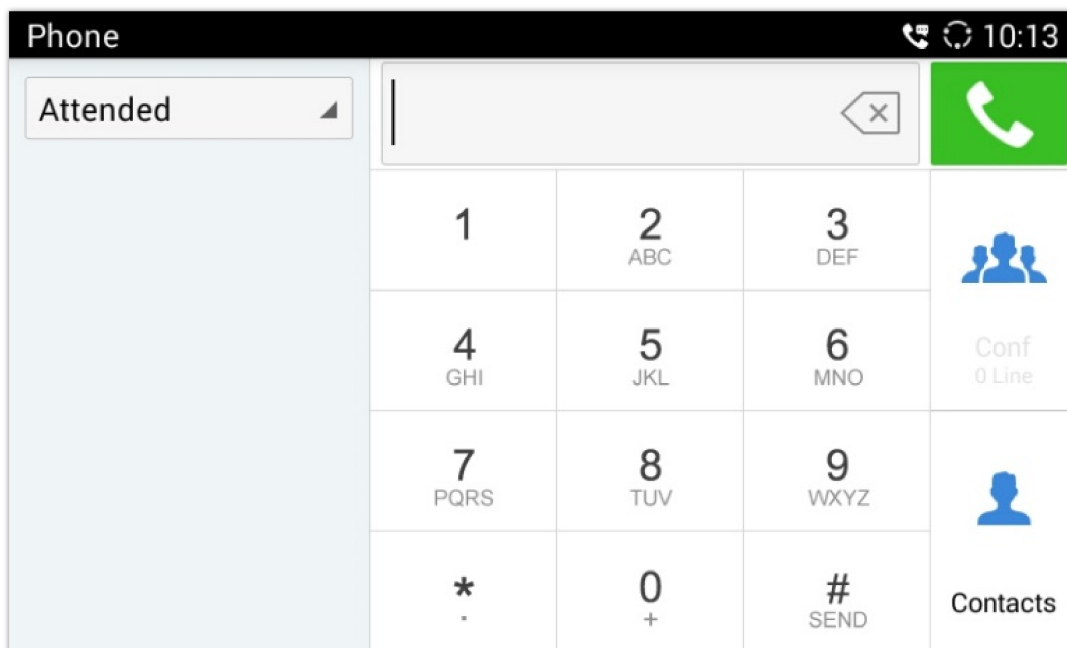

GAC2500 Call Forward – Select Forward Mode

3. Input digits and then press the Send soft key;
4. Users will hear the ring back tone and see the prompt as shown below. Hang up the phone to transfer the call to the third party C automatically; press the "Cancel" button will cancel the transfer;

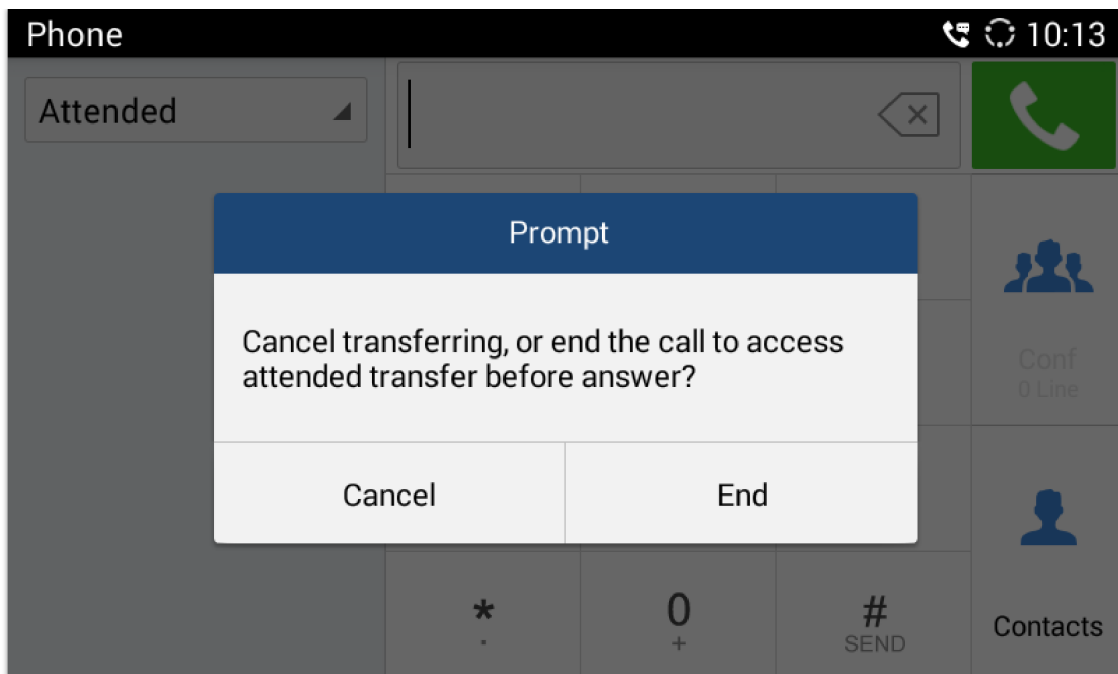

GAC2500 Call Forward – Transferring

5. User A could press the “Transfer” button to forward the call to user C. Click on “Split” button to establish line with the third party, while user B will be put on hold.

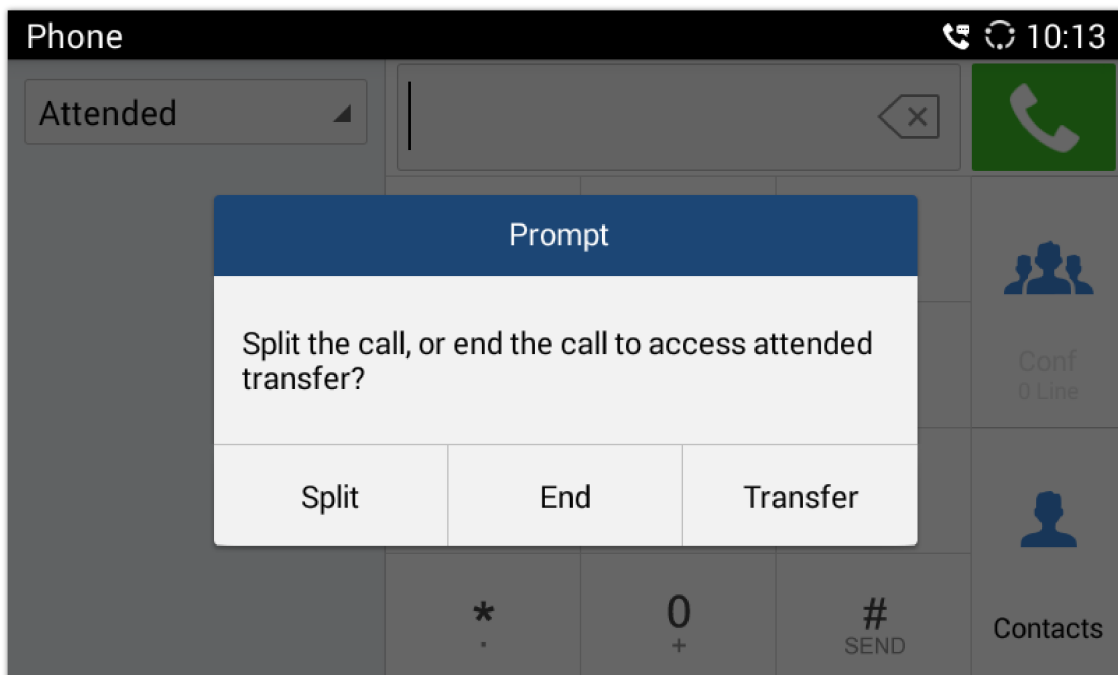

GAC2500 Call Forward – Split

DND (Do Not Disturb)

When DND is on, the incoming calls to the GAC2500 will be blocked without ringing. Users could see the blocked calls in call history. Once enabled, the DND icon  will be displayed in the status bar on the top of the screen.

1. Hold the screen at the top of the status bar, drag and drop down to open the status bar.
2. Touch the DND icon  to turn it on/off.

Note

- When DND is on, the active call will not be affected, all the calls after to the registered accounts will be blocked.
- When DND is on, the incoming calls to the GAC2500 will be saved in the call history.

Missed Call

When there is a missed call, the LCD will show missed call screen instead of regular idle screen.

Users can tap on the one of missed call entry to access the missed call log. To close the missed call screen and return to the idle screen, tap on  on the upper right.

Call Forward

Call forward (Unconditional/No-answer/Busy/Time-based) can be set up on device or from web GUI. Log in GAC2500 web GUI and go to Settings page→**Account**→**Call Settings**. For details, please refer to “GAC2500 Administration Guide”.

Set On LCD

Go to Settings→Personalized account to select the account and access configuration page and Tap on Call Forwarding Type to access and specify the forward type.

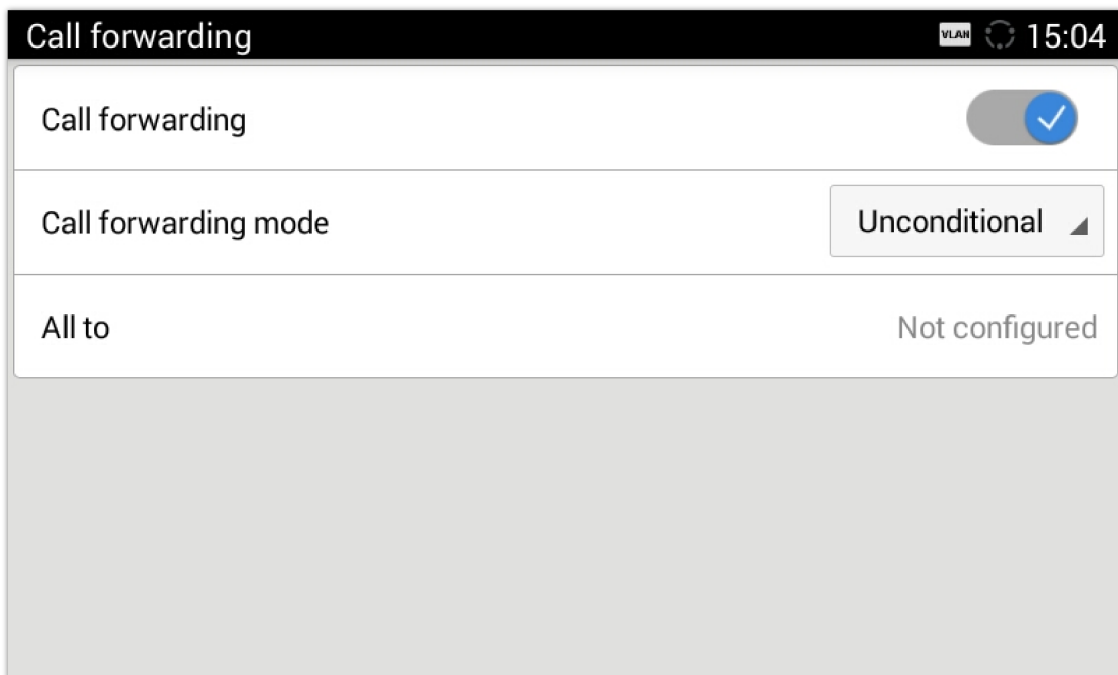

GAC2500 Call Forward Type Setting Screen

- **Unconditional:** Forward all calls to particular number
- **Time based:** Forward calls based on the time range.
- **Busy:** Forward calls when an active call exists.
- **No-answer:** Forward calls when phone is not answered.

Set from Web GUI

Log in the Web GUI and go to **Account**→**Call Settings** to find Call Forward option as shown below and specifies the call forward mode in the drop-down list.

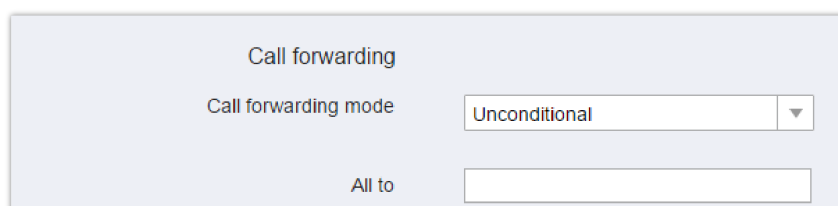

GAC2500 Call Forward Mode On Web GUI

7-way Conference



The GAC2500 supports up to 7-way conference. The GAC2500 can be the host to initiate a conference or join other conferences as a party.



Initiating Conference

The conference can be initiated from dial screen, or start conference from schedule. The following steps introduces two ways to start conference from dial screen, please refer to chapter [Schedule Conference](#) for more details about initiating conference from schedule.

- o **Enter multiple numbers in the text box or select parties from the list below.**

1. Access dial screen when the phone is on idle;
2. Set call mode and select account;
3. Enter digits in the textbox;
4. Tap on the matching phone number on the left to add it to the textbox, you can add multiple numbers.
5. Repeat the steps 3-4 to add more numbers;
6. Tap on  to dial out.

- o **Press  to access conference page, then tap on  to add parties.**

1. Access dial screen when the phone is on idle;
2. Tap on Conf button  or the icon  on desktop to access conference page as shown below;

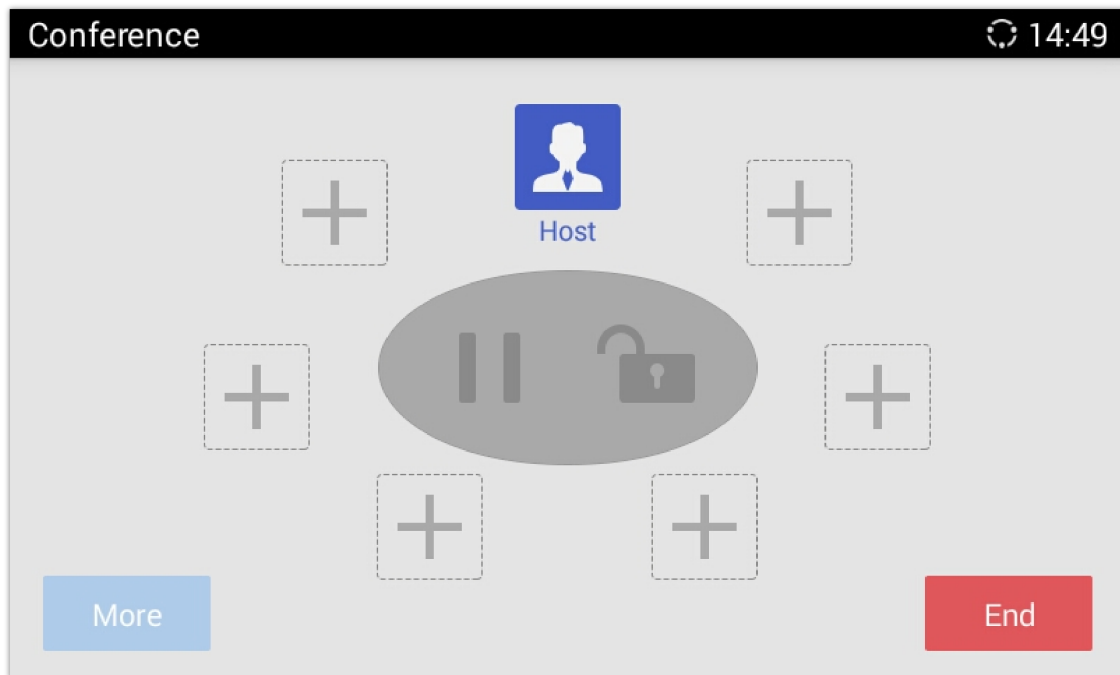

GAC2500 Conference Screen

3. Tap on  to start adding parties to conference;

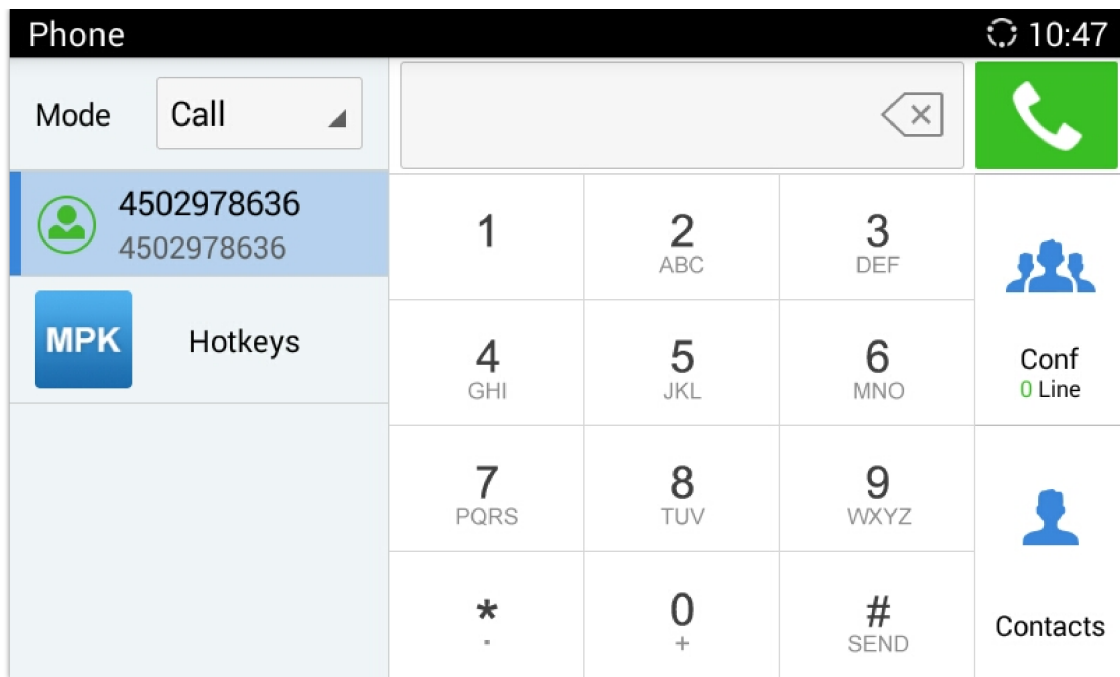

GAC2500 Add Party To Conference

4. Enter digits and then tap on  to dial out;

5. Repeat the steps 3-4 to add more parties.

Note

- o You can add multiple members to conference at one time.
- o You cannot stay in one single active line once joined conference.

Answering an Incoming Call in Conference

You can specify how your GAC2500 handles incoming calls. Depending on your configuration, your GAC2500 automatically answers a call or prompts you to answer a call manually. Log in GAC2500 web GUI and go to Account→Call Settings and set "Auto-answer" option to "Yes", or go to **Settings→Personalized Account→Account** and set "Auto-answer" to "Yes" on GAC2500. Once enabled, All incoming calls will be automatically answered, you can see the icon  displayed on the status bar.

During a conference call, when an incoming call is received, the following prompt will be displayed:

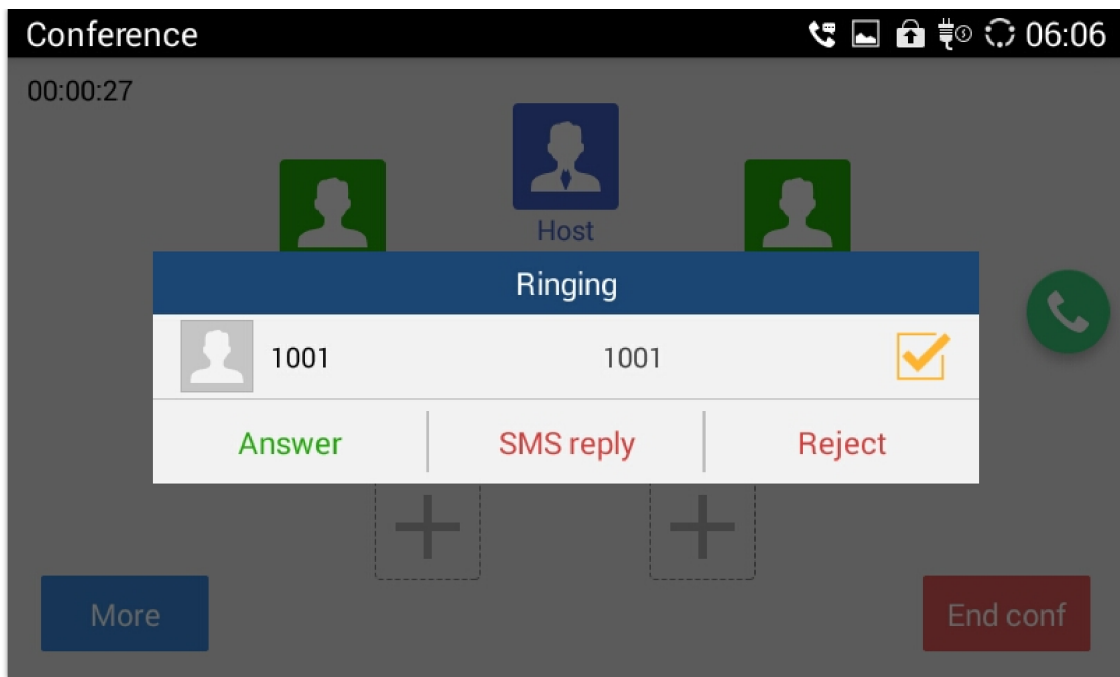

Conference Incoming Call

If the call is answered, it will be added automatically to the conference.

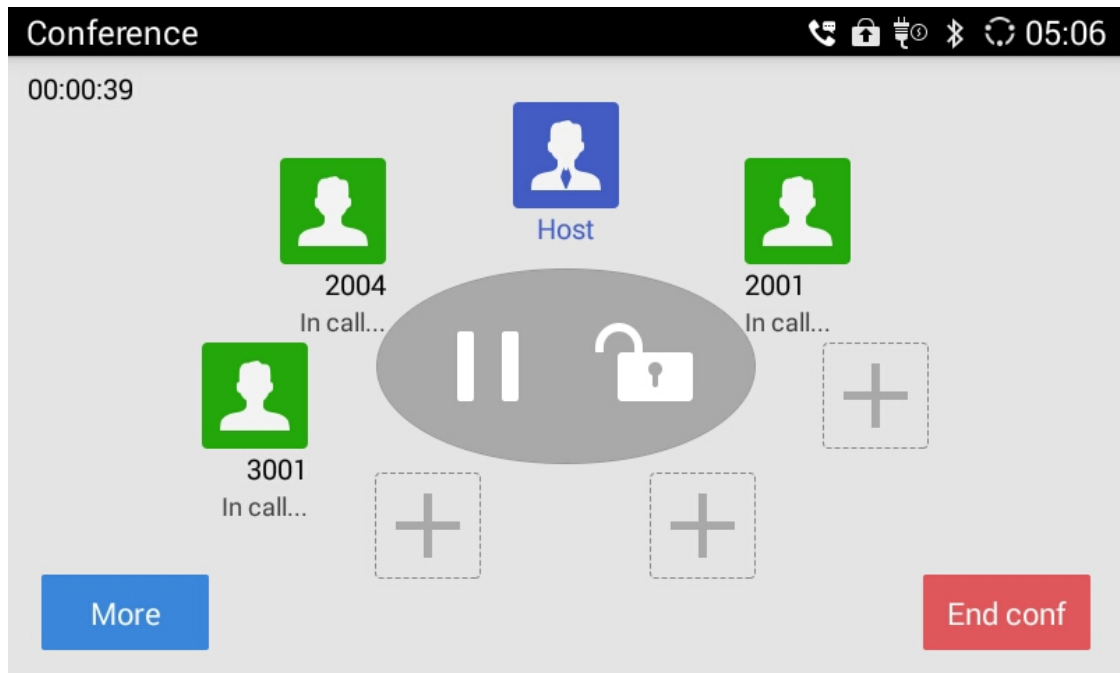

Call Added to Conference

Conference Management



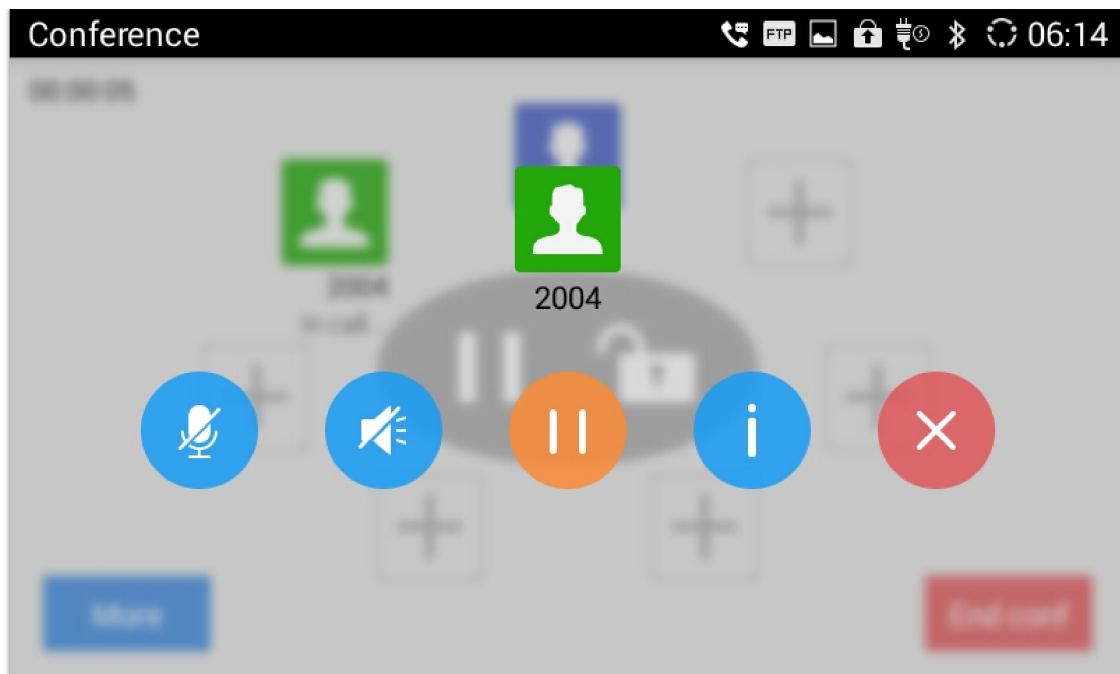

The following figure shows a 3-way conference established.







GAC2500 3-Way Conference

Tap on participant icon to bring up more operations.

 **Redial.** Tap on the icon to dial out again if the call failed.

 **Mute.** Once enabled, the icon next to the conference member will turn to , and the Mute icon becomes . The selected member will not be heard by other parties. You can tap on  to unmute the member.

 **Block.** Once enabled, the icon next to the conference member will turn to , and the Block icon becomes . The selected member will not hear other members. You can tap on  to unblock the member.

 **Hold.** Tap to put participant on hold.

 **Details.** Tap to view conference details, including whether to use SRTP or codec.

 **Delete.** Tap to delete conference members.

More. Bring up more options including Open DTMF, Mute All, Block All, etc.

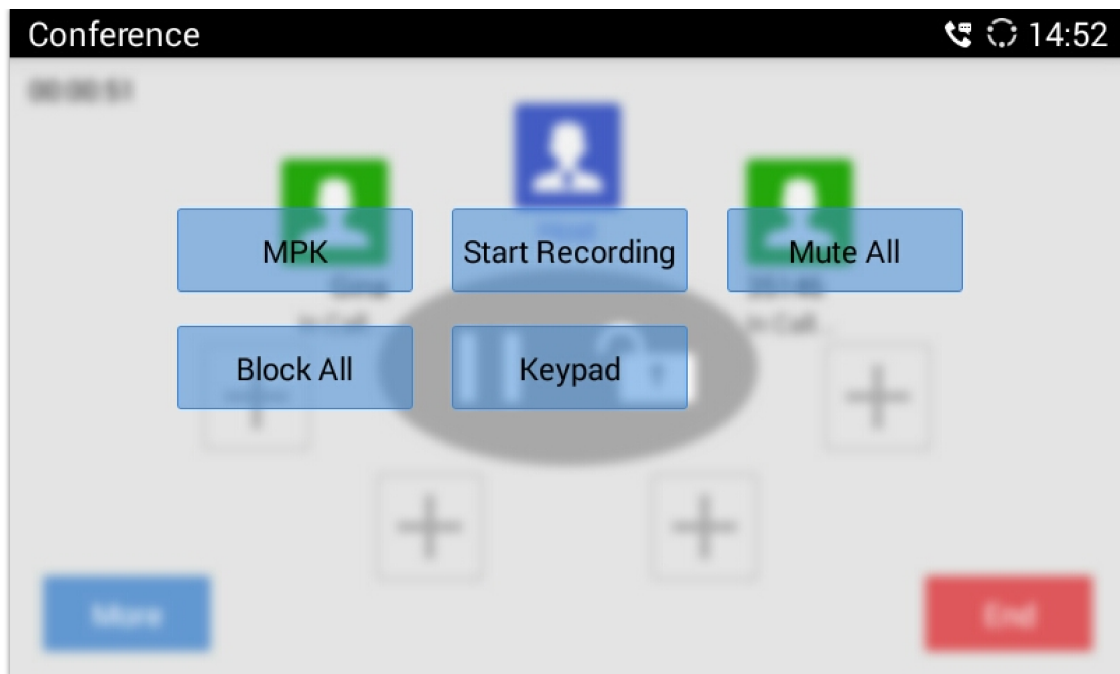

GAC2500 Conference-More

- **MPK.** Tap to access MPK interface.
- **Mute All.** Tap to mute/unmute all parties except the host.
- **Block All.** Tap to block/unblock all parties except the host.
- **Start Recording.** Tap to start/stop recording. The recording file will be saved automatically.
- **Keypad.** Tap to pen DTMF keyboard.



Hold. Hold/UnHold conference.

Lock. Lock/Unlock conference.

End. End conference and go back to home screen.

Invite Members to Conference

Users could use one of the following ways to add members.

- Access the dial screen by clicking on the ADD icon  on conference screen. Then enter the number to dial out. Once the member answers the call, it will be connected into the conference automatically.
- Tap on  to access the dial screen, then enter the number to dial out. Once the member answers the call, it will be connected into the conference automatically.
- The member calls the conference number. If the host answers the call, the member will join conference automatically.

Removing Member from Conference

To remove a member from the conference, tap on the member icon and click  to delete it.

Third Party Applications

The GAC2500 runs the Android Operating System and therefore offers full access to the hundreds of thousands of Android apps in the Google Play Store, including Skype for Business™, Google Hangouts™ etc. For example, to use third party app Skype for Business™ during the conference:

1. Establish a conference call on the GAC2500;

2. On conference screen, click on  ;
3. Input numbers or contacts of Skype for Business™ and dial out;
4. The new call will be added to conference.

Notes

- o You should install the third party app and sign in first.
- o You should go to Web GUI→**Advanced**→**Call Features** and set Display Soft Keyboard as Yes.
- o Some third party apps may not support the GAC2500's dial pad, you have to go to the application's GUI to dial out.
- o If you dial SIP numbers and third party apps' numbers at the same time, the SIP numbers will be dialed out first and go to the conference room, you need return to the dial pad, and then the third party apps' numbers will be dialed out automatically.
- o In order to fully use of Skype for Business™ (Lync), you should download it from the GS Market. Other versions may not compatible.

End Conference

To end the conference, tap on END button to disconnect. If the GAC2500 is the conference host, ending the conference will disconnect all the members from the conference. If the conference member hangs up the call, it will be disconnected from the conference but other parties in the conference will stay in the conference.

Schedule Conference

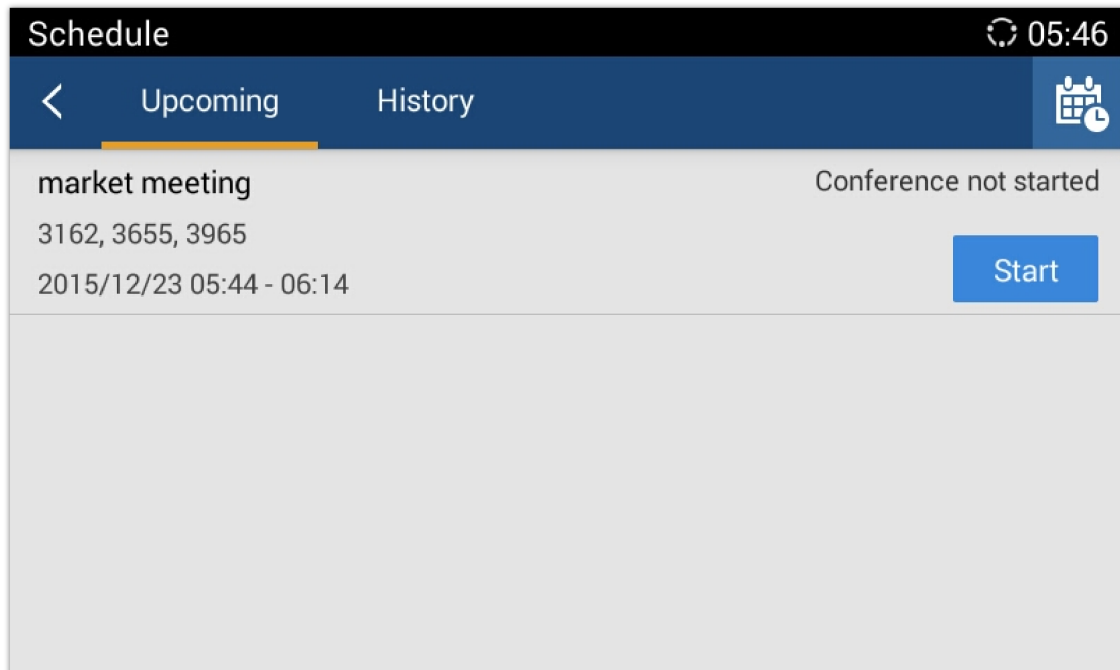

Schedule feature allows the user to set a specific time to hold a conference in advance, with conference reminder and members.

Tap on  on desktop to access Schedule screen, the schedule page is shown below, including upcoming conferences and conferences that has been held:



GAC2500 Schedule Screen

View Conference Details



Users could view scheduled conference details after the current time. Select one conference and tap to view conference details. Press  on the upper left corner or  to exit.



GAC2500 Conference Details Screen

Add Scheduled Conference

Follow the steps below to add a scheduled conference:

1. Tap on  on desktop to access Schedule screen.
2. Tap on  on the upper right corner to access "Add Conference" screen as below.

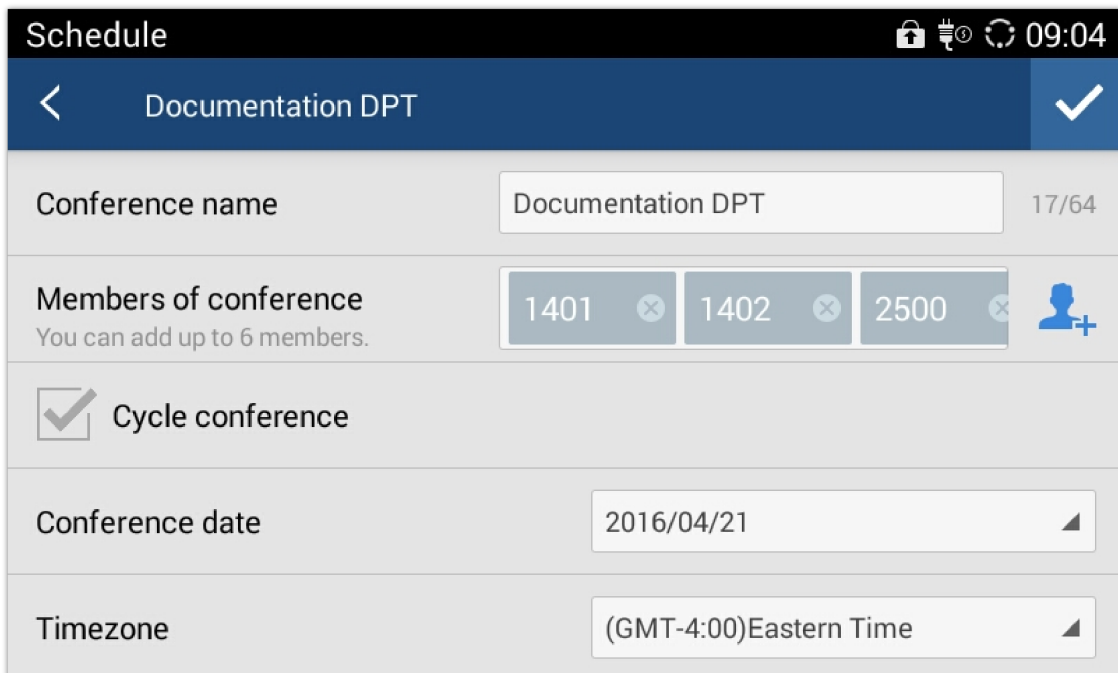

GAC2500 Add Conference Screen

3. Fill in conference name, members, start time, conference duration, etc.;
4. Tap on  to save the scheduled conference and go back to schedule screen.

Parameters	Descriptions
Conference name	Set the conference name to identify this conference.
Members of conference	<p>Click on the add button to access the Add Member screen. You can add one member or a group of members. Tap on</p>  <p>on the upper right corner to save and go back to the Add Conference screen. Up to 6 members can be added. Note: You can only add up to 6 members.</p>
Cycle conference	Set conference cycle.
Conference date	Configure the date when the conference starts. It should not be earlier than the current date.
Time zone	Configure conference time zone.
Start Time	Configure the time when the conference starts. It should not be earlier than the current time.
Duration (Min)	Configure conference duration.
Reminder time	Configure whether to remind users in advance. A prompt dialog box will pop up on the GAC2500 screen before the conference starts.
Auto conference	Configure whether to initiate conference when the conference time comes. If disabled, a prompt dialog box will pop up on the GAC2500 screen 10 minutes before the conference starts to remind users whether to start conference.
Auto-answer for conference member	Configure whether to answer the call from the conference member automatically. If the call is not from the conference member, it will not be answered automatically.
Lock	Users could lock/unlock the scheduled conference. Once locked, the other incoming calls will not be able to join conference. The conference screen will display the lock icon when the scheduled conference started, you can also disable this function, please refer to chapter Conference Management for more details.
Auto record	Configure whether to record automatically once the conference started. If enabled, it will record when the conference starts (with active line).
Block when enter	Configure whether to block conference members when they enter conference. If enabled, conference members who auto answered will not hear others unless unblocked by the host.

GAC2500 Add Conference Parameters

Schedule Conference via Google Calendar

Access Schedule screen, then tap on



, the following page is shown:

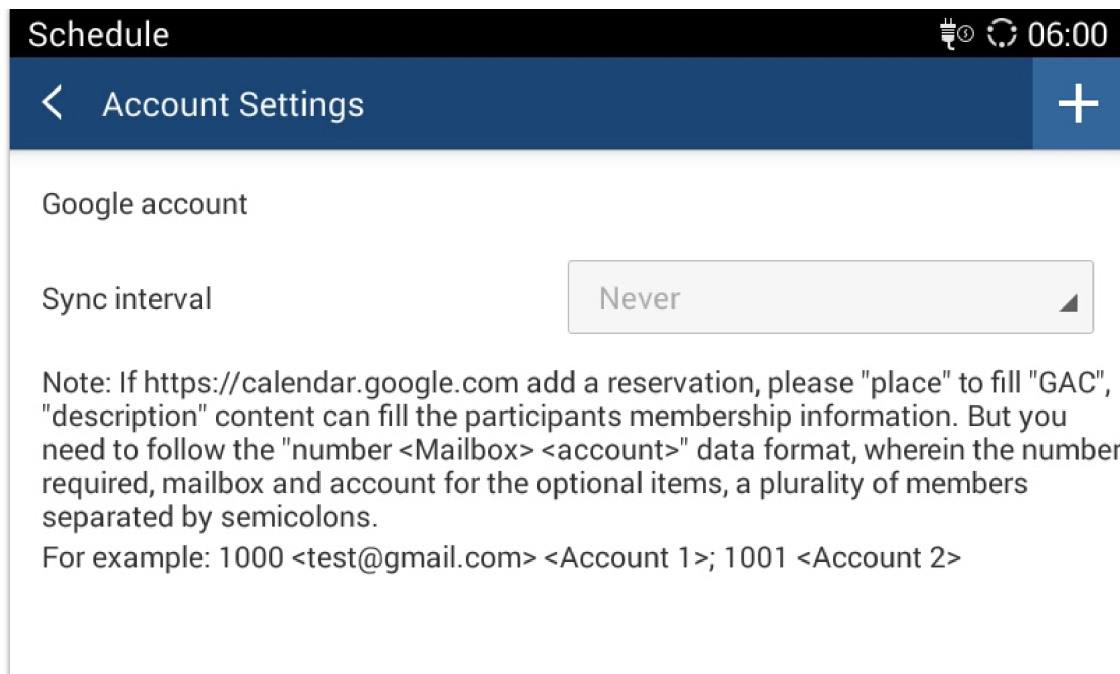

Add Google Schedule

1. Click on  .
2. Add an existing or create a new email, and follow instruction.
3. Once done the following screen will be shown:

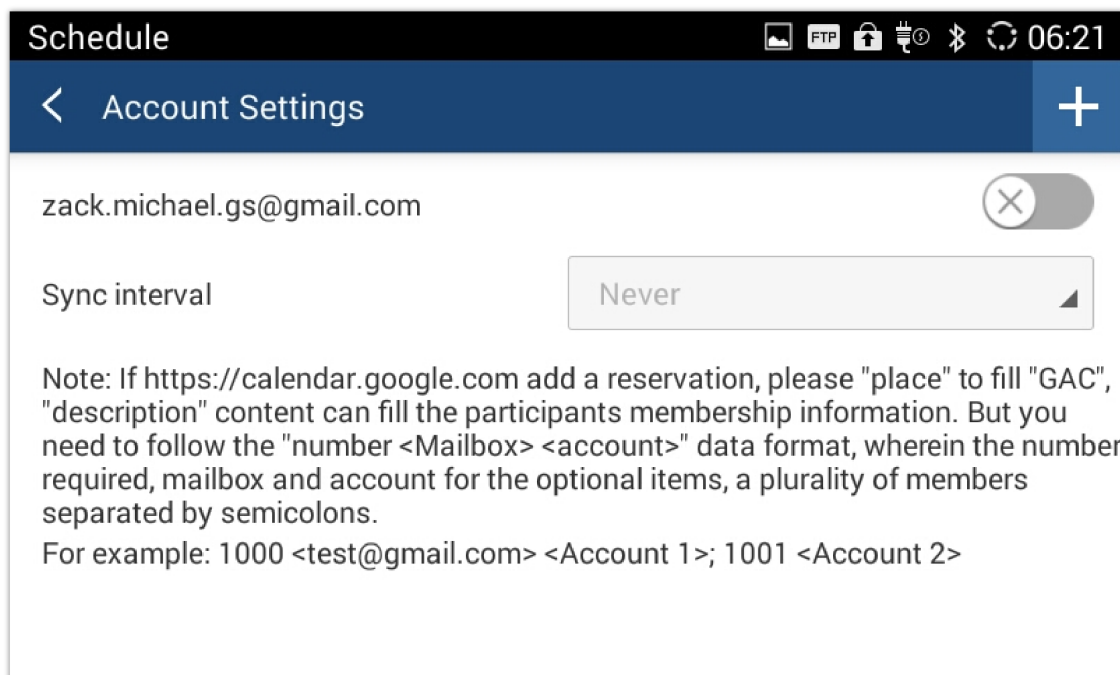

Select Google Account

4. Click on account Settings, then go to the google account and create a new event Then enter conference members in "Description" option. The members should be in the format: **Number**<Email> <Account> "Number" filed is required while the other two fields are optional.

For example: 1000<test@gs.com> <1000>;0655443322<gsconf@gs.com>;0655443311

5. After creating the conference go back to the schedule screen and tap on



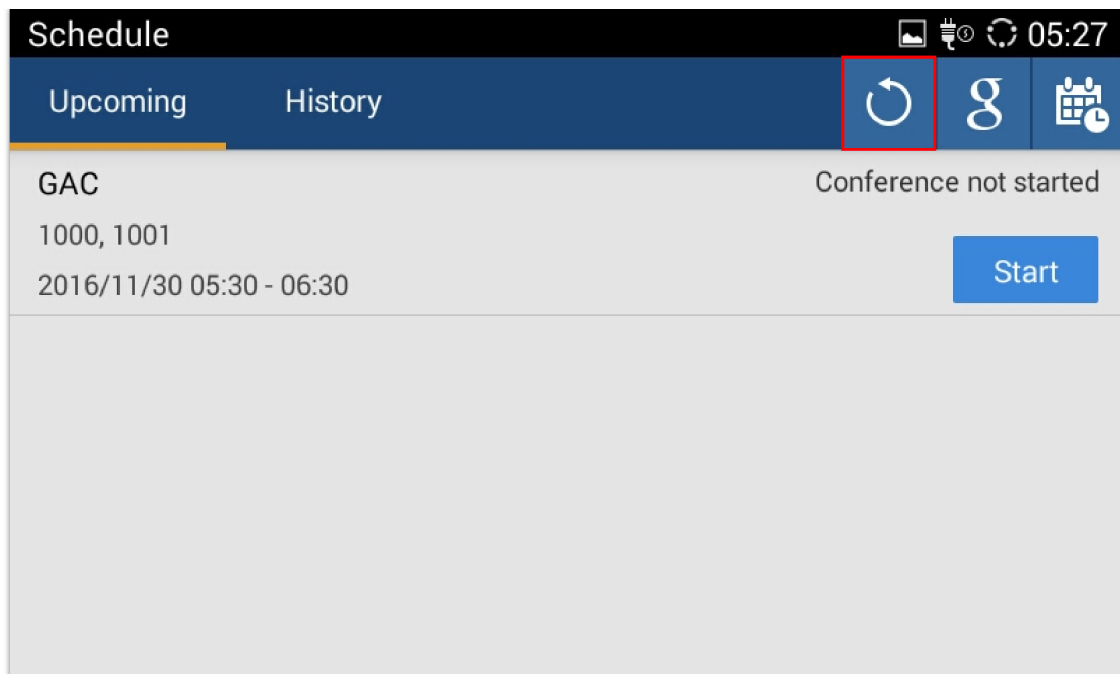



Google Calendar Conference



Edit Scheduled Conference

Follow the steps below to edit scheduled conference:

1. Access conference schedule screen and select the conference entry you would like to edit.
2. Tap on  on the upper right corner to access edit screen.
3. Tap on  on the upper right corner to save changes and go back to schedule screen.

Reschedule Conference

If you want to reschedule the conference that has been held, please refer to steps in chapter [Edit Scheduled Conference](#) to edit conference again and save.

1. Go to Schedule app → History section.
2. Slide left to go to conference history.
3. Tap on the reschedule icon  to configure it.
4. Tap on confirm icon .

Delete Scheduled Conference

Follow the steps below to delete the existing scheduled conference:

1. Access Schedule screen;
2. Long press the conferences entry to access the edit screen as shown below:

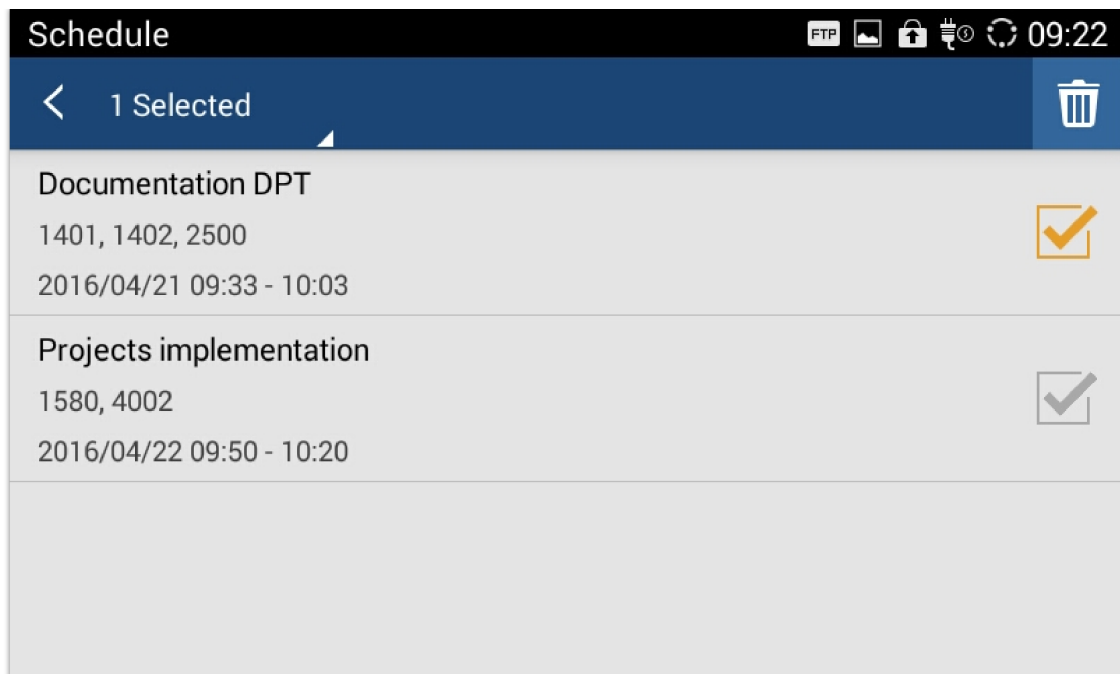

GAC2500 Delete Scheduled Conference Screen

3. Check the conference (s) you want to delete and tap on  on the upper right corner to delete.

Delete History Conference

You can see all scheduled conferences which has passed the scheduled time in "History" option, you can edit/delete/reschedule the conference here.

There are 2 ways to delete history conference.

- **Delete single conference entry.**

1. Access schedule screen and select the conference entry you would like to delete;
2. Slide left on screen as shown below and tap on  to delete conference.

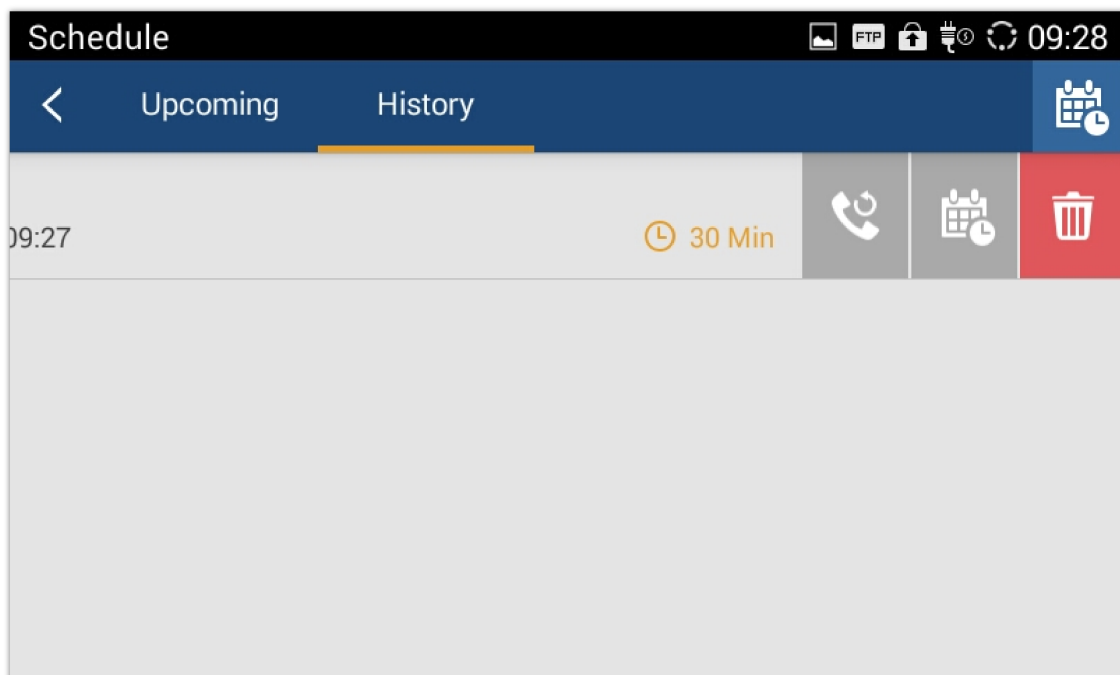

GAC2500 Delete History Conference Screen

- **Batch delete conference entries.**

1. Access Schedule screen;

2. Long press the conferences entry to access the edit screen as shown below:

3. Check the conferences you want to delete and tap on  on the upper right corner to batch delete conferences.

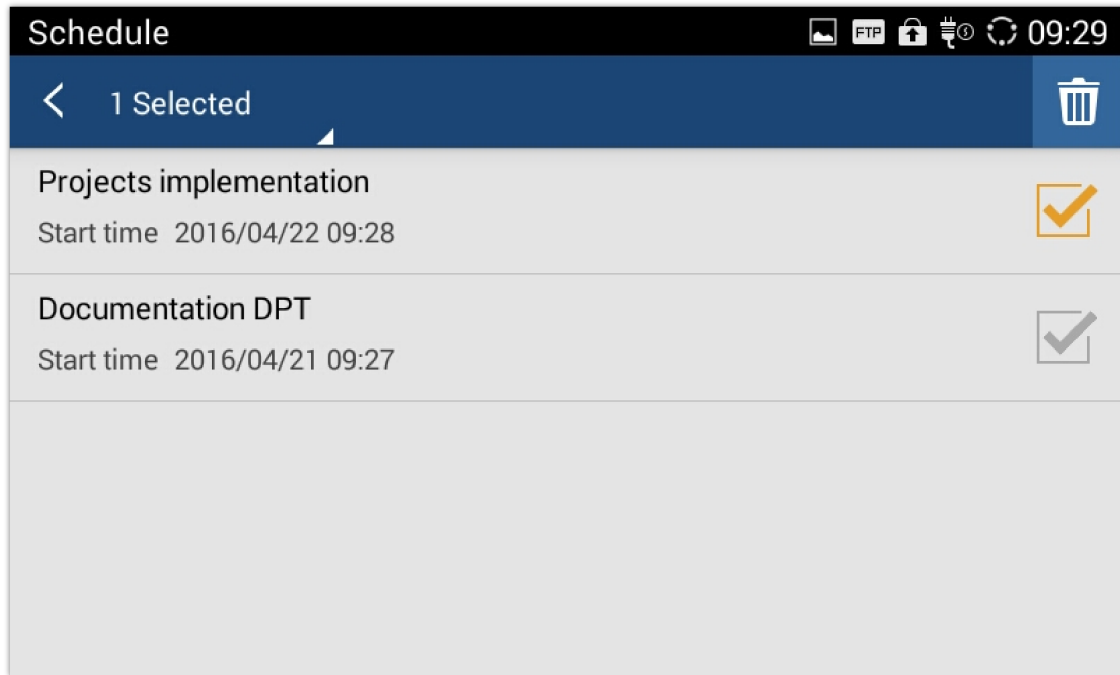

GAC2500 Batch Delete History Conference Screen

Voicemail

When there is a new voicemail, voice mail icon  will show up as a notification in the status bar. Users could go to LCD **Settings**→**Advanced settings**→**Account**, or login the web UI→**Settings**→**Account**→**General Settings**→**Voice Mail** UserID to configure the access number for the voicemail.

Follow the steps below to access voicemail:

Access the dial screen and input voicemail access number;

Tap on  on the dial screen to dial into the voicemail box;

Follow the Interactive Voice Response (IVR) for the message retrieval process.

Users could also tap on  to access the voicemail box. The number of new voicemail messages will be shown on the voice mail app icon as well. See figure below.

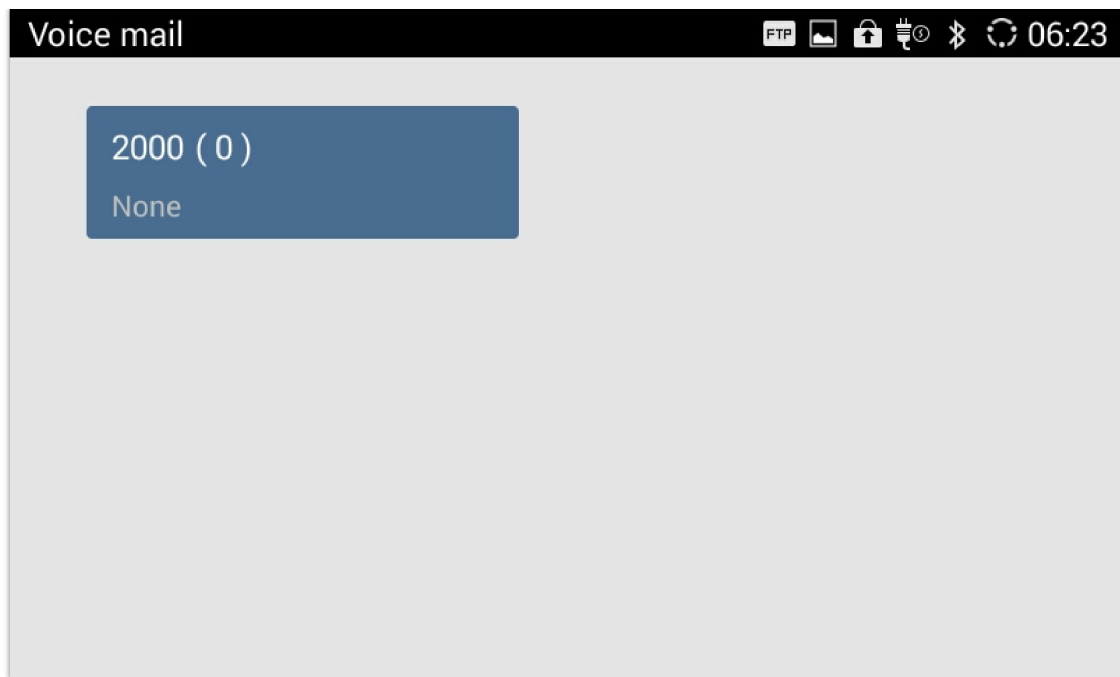

GAC2500 Voice Mail Application

APPLICATIONS

GAC2500 provides built-in applications such as like Contacts, Call History, File Manager, Browser and etc. Users could also download the apps from GS market to install on the GAC2500.

Contacts

GAC2500 Contacts app helps users to easily store and manage phone number and contact information. Users can add contacts on the GAC2500 or import contacts from external devices as well as download from a server. On the GAC2500 home screen, you can see local Contacts and LDAP Contacts.

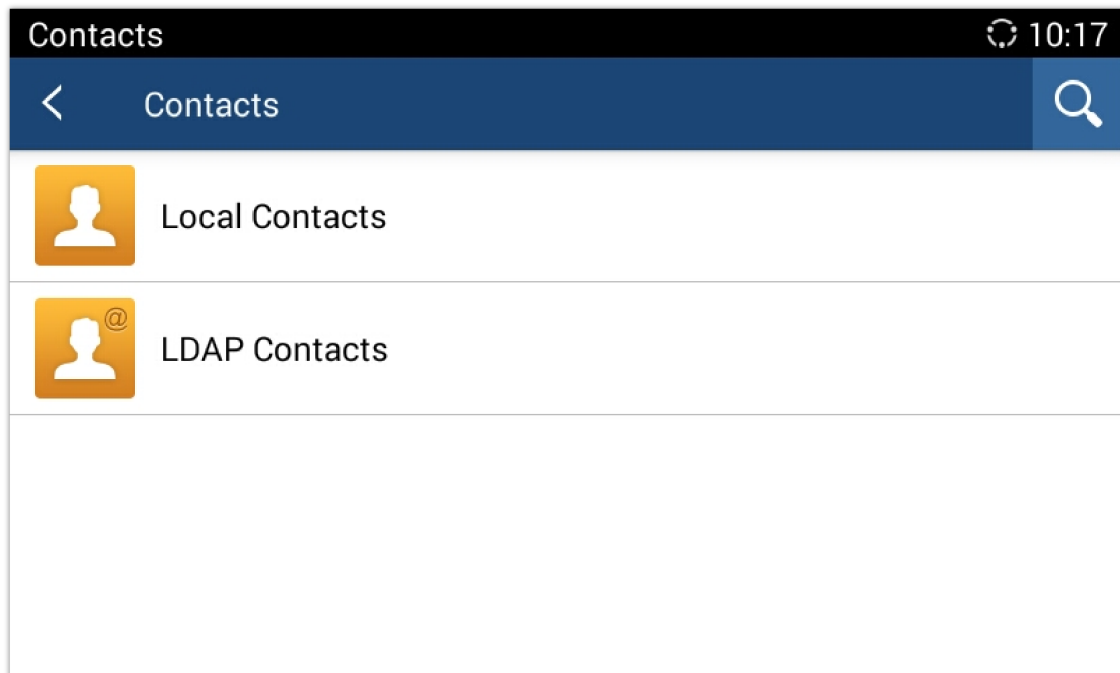



GAC2500 Contacts Screen

Local Contacts

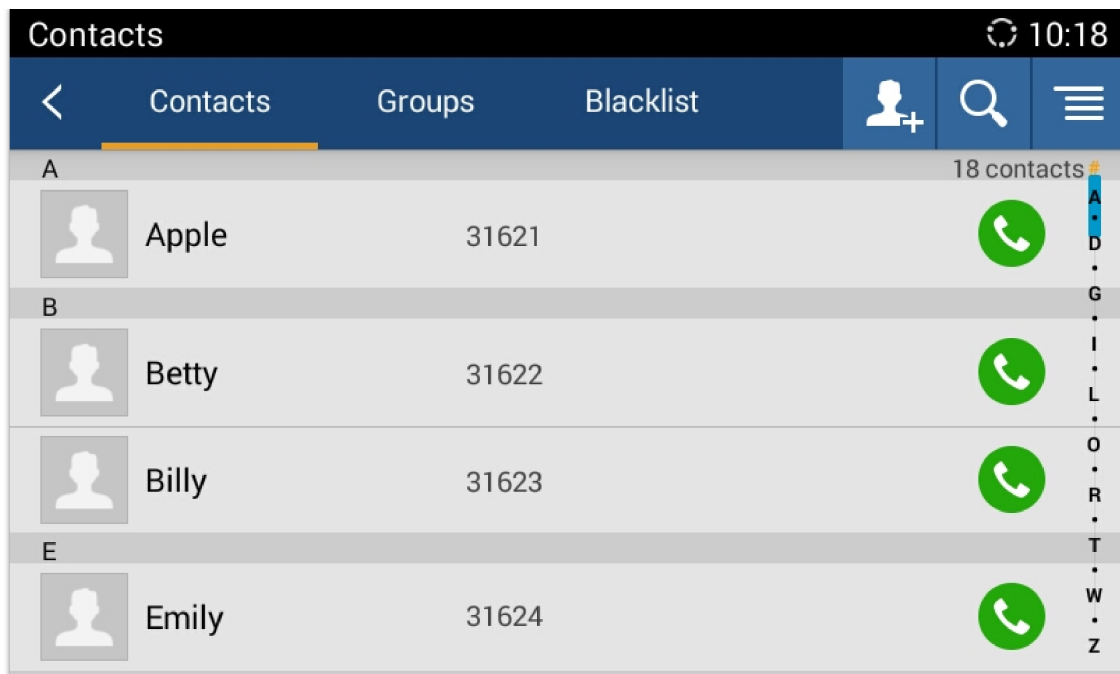
The Local Contacts screen shows as follows:



GAC2500 Local Contacts Screen

- **Back.** Back to the previous page.
- **Contacts.** Display all contacts.
- **Groups.** View groups. Select one group to view group details.
- **Blacklist.** Display blacklist.
- **Call.** Tap  on the contact you would like to call.
- **Add Contact.** Tap to access New Contact screen. Fill in contact information and save.
- **Search Contact.** Tap to access Search Contact screen.
- **More.** Tap on  to export/import/download Contacts, view storage status or sort Contacts.
- **Contact Details.** Select one contact to view contact details.

Add Contact

- **Add Single Contact**

Follow the steps below to add one single contact.

1. On the Contacts screen, tap on the button  to access New Contact screen;

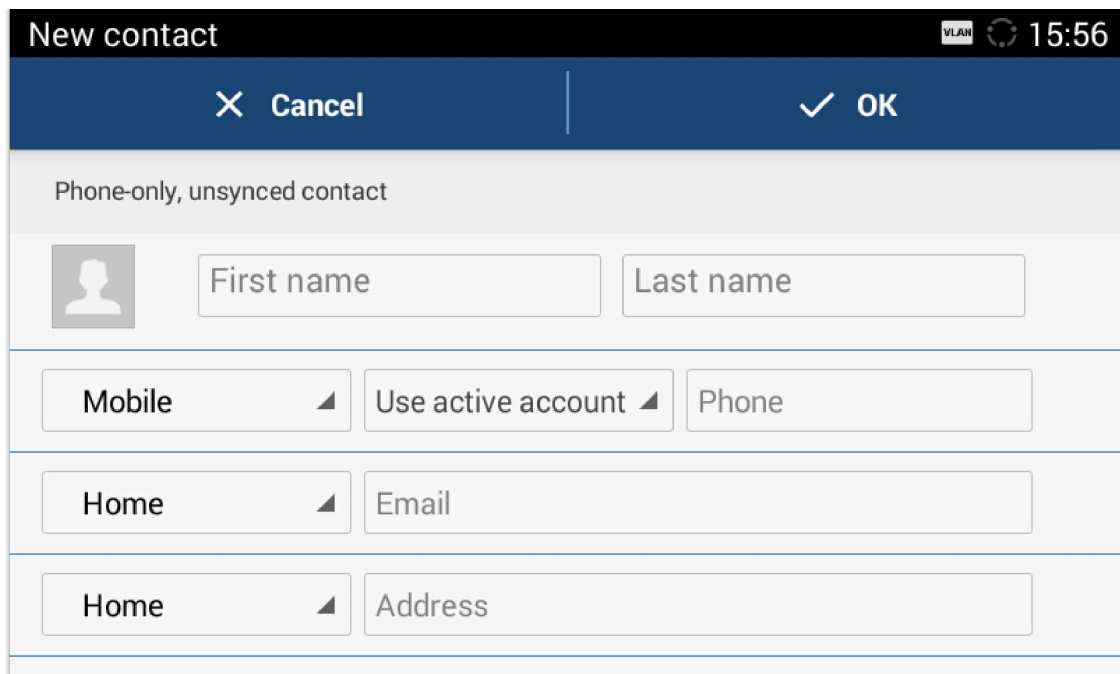

GAC2500 Add New Contact Screen

2. Enter contact information. Choose the account on the left of the "Phone" field to dial out this number;
3. Click "OK" to save the contact information.

o **Batch Import Contacts**

Import function allows users to batch import contacts. The phonebook with compatible format needs to be saved to the storage devices like SD card/USB flash drive and plugged into the GAC2500.

1. On the Contacts screen, tap on the MENU key  on Contacts screen and select "Import" to access Import Contacts screen;
2. Configure parameters and select the path to save the imported file;
3. Click "OK" to save the contact information.

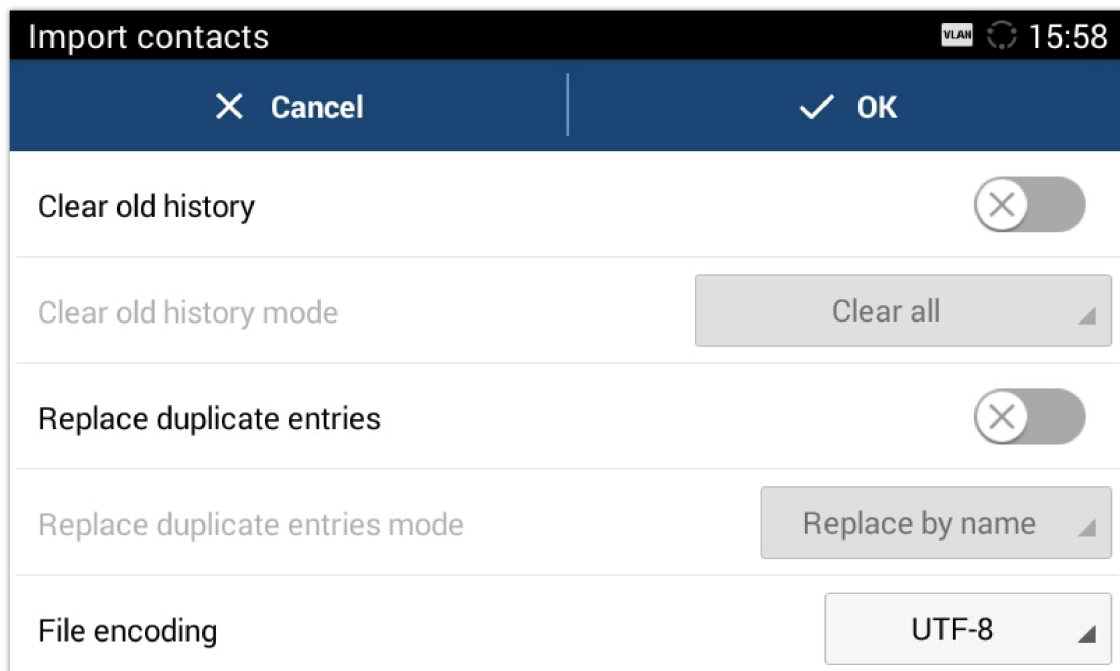

GAC2500 Import Contacts Parameters Screen

Parameters	Descriptions
Clear old history	If enabled, the previous contact records will be deleted when a new phonebook file is loaded into the phone. If disabled, both the old contacts and new contacts will be kept in the

	GAC2500.
Clear old history Mode	Configures whether clear all contacts or reserve local contacts when clear old list. The default setting is "Clear All".
Replace duplicate Entries	If enabled, when the phonebook file is imported to the phone, the duplicated entries will be removed. If disabled, both the old contacts and new contacts will be kept in the GAC2500.
Replace duplicate Entries Mode	You can replace duplicate entries by name or number.
File encoding	Select the encoding format for XML contact file.
File type	Select the file format for phonebook file import. The device supports xml, csv and VCard format.
Select file	Select file from storage device plugged into the GAC2500.

GAC2500 Import Contacts Parameters

Download Contacts

GAC2500 supports downloading phonebook from the file server to batch add contacts. The default file name the GAC2500 looks for is "phonebook.xml". The phonebook XML file should be placed under the file server directory for the GAC2500 to retrieve. The GAC2500 supports VCard/xml/csv file format.

1. On the Contacts screen, tap on the MENU key  and select "Download" to bring up the Download Contacts screen;
2. Configure parameters and select the path to save the file;
3. Tap on the "OK" key to save the contact information.

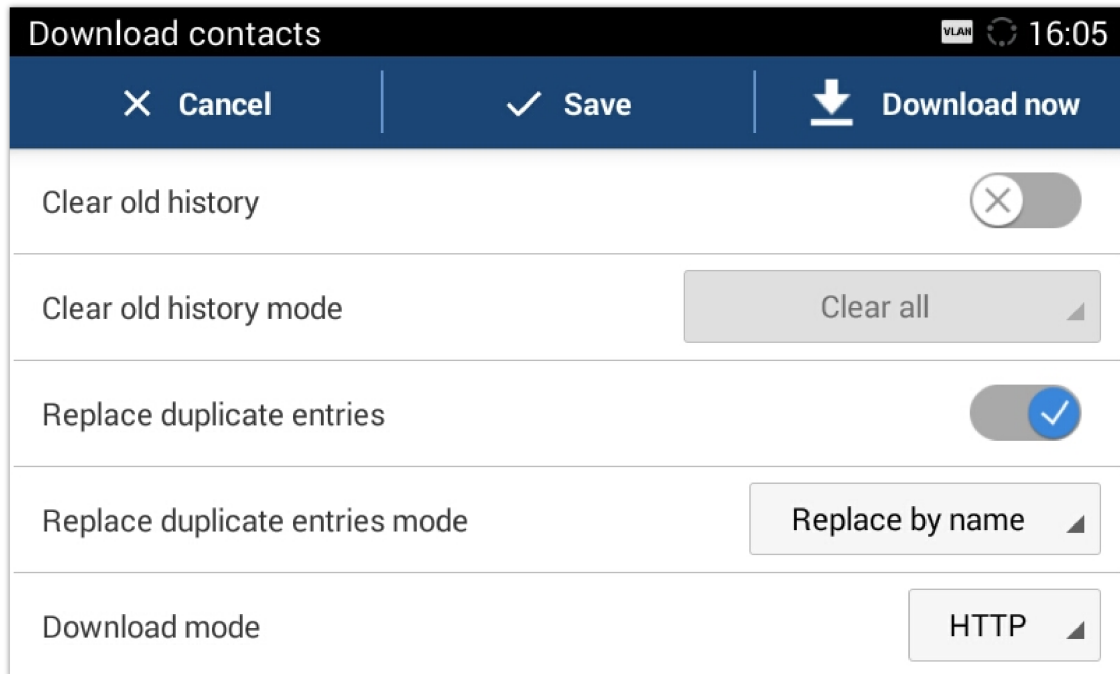

GAC2500 Contacts Screen

Parameters	Descriptions
Clear old history	If enabled, the previous contact records will be deleted when a new phonebook file is loaded into the phone. If disabled, both the old contacts and new contacts will be kept in the GAC2500.

Clear old history mode	Configures whether clear all contacts or reserve local contacts when clear old list. The default setting is to “Clear All”.
Replace duplicate entries	If enabled, when the phonebook file is downloaded to the GAC2500, the duplicated entries will be removed. If disabled, both the old contacts and new contacts will be kept in the GAC2500.
Replace duplicate entries mode	You can replace duplicate entries by name or number.
Download mode	Select the phonebook download mode from TFTP, HTTP or HTTPS.
File encoding	Select the encoding format for the XML contact file.
Time intervals	Configure the time interval to download XML contact file.
Download server	Fill in the server URL or IP address to download the XML contact file to the device.
Username	The username that may be used for download server login
Password	The password that may be used for download server login

GAC2500 Download Contacts Parameters

Search Contacts

GAC2500 supports Search function, users could tap on  icon on the Contacts page and input the keyword to search in the pop-up dialog. GAC2500 will automatically display contacts items related to the search info. Fuzzy search and precise search are both supportive.

Manage Contacts

○ Delete Contact

1. Long press the contact you would like to delete to access edit screen;
2. Check the contact, or click the button on the upper left corner of the toolbar for quick operation. “Select All” indicates check all select entries while “Cancel All” indicates uncheck all selected entries;
3. The digit on the upper right corner indicates how many contacts you have selected, tap on  to delete contacts you selected.

○ Star Contacts

In GAC2500, users can add at most 18 star contacts.

1. Locate a contact from the list, tap on the contact, shown as below.

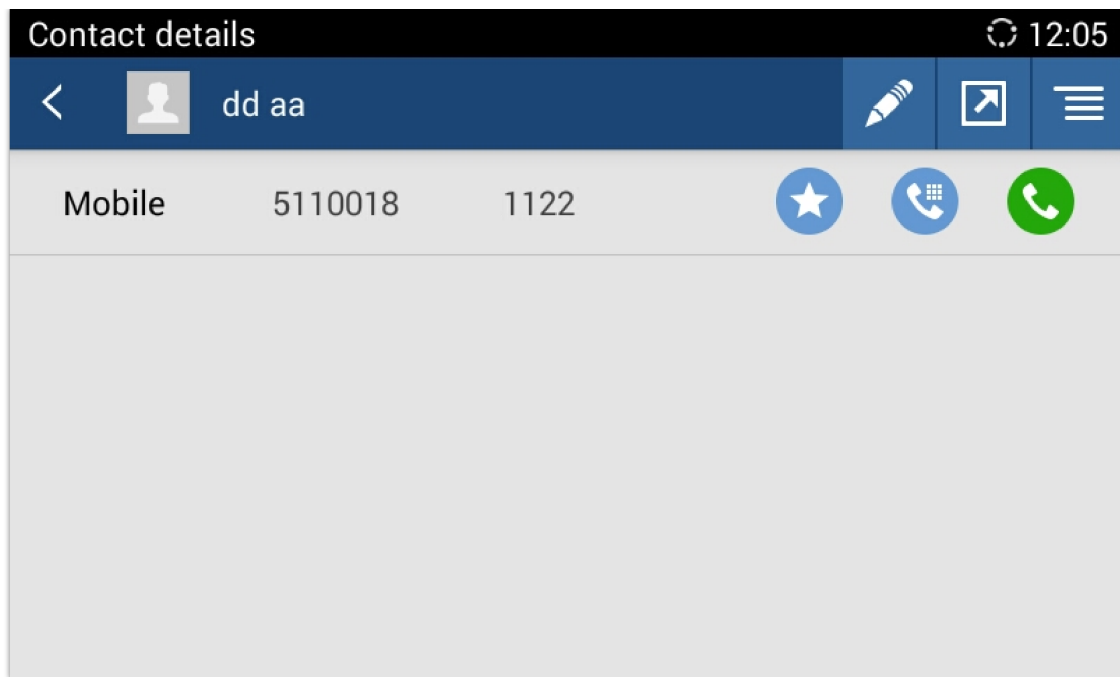

GAC2500 Contact Edit Page

2. Choose a number to star, and tap the icon  on the right. Then the number will be displayed on the top of contacts list.

o **Create Contact Short Cut**

GAC2500 supports creating a shortcut of a contact to desktop, or to speed dial hotkey.

1. In Contacts app, find the contact to create shortcut, tap on the contact to edit the detail.

2. Tap on the send icon  and choose shortcut mode in the prompt.

Note

When a contact has multiple numbers, choosing "Send to Speed Dial" would create multiple hotkeys in the app.

o **Export Contacts**

The GAC2500 supports exporting phonebook as VCard/xml/csv files and save the files to other external storage devices.

1. Press the MENU key  on Contacts screen to bring up the Export contacts screen.

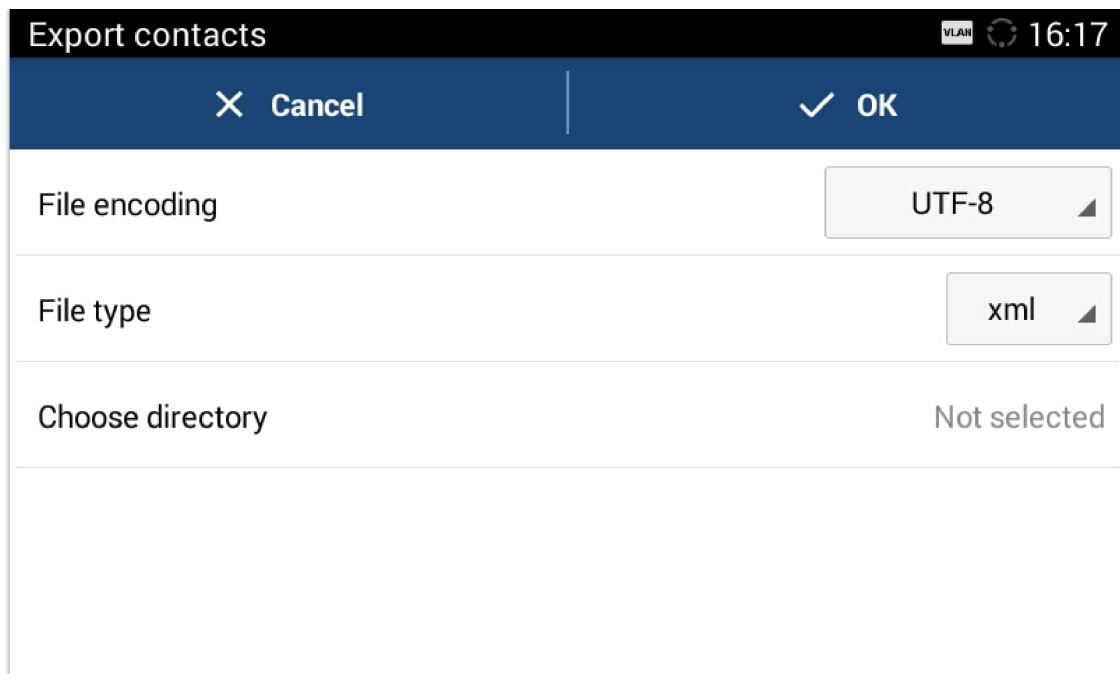

GAC2500 Export Contacts Screen

2. Configure parameters as shown in table below and select the directory to save the exported file.
3. Tap on the "OK" key to export the file.

Parameters	Descriptions
File encoding	Select the encoding format for XML contact file.
File type	Select the file format for phonebook file export. The device supports xml, csv ,vcard.
Choose directory	Select directory to save file.

GAC2500 Export Contacts Parameters

o **Send Contacts**

1. Long press the contact you would send to enable edit screen;
2. Check the contact you want to send;
3. Choose the way to send contact. If Bluetooth Device Chooser has been enabled, users could send the contact to the paired user via the Bluetooth.

o **Contacts Storage Status**

Tap on  the Contacts page to view the contacts storage. You can store up to 2000 entries.

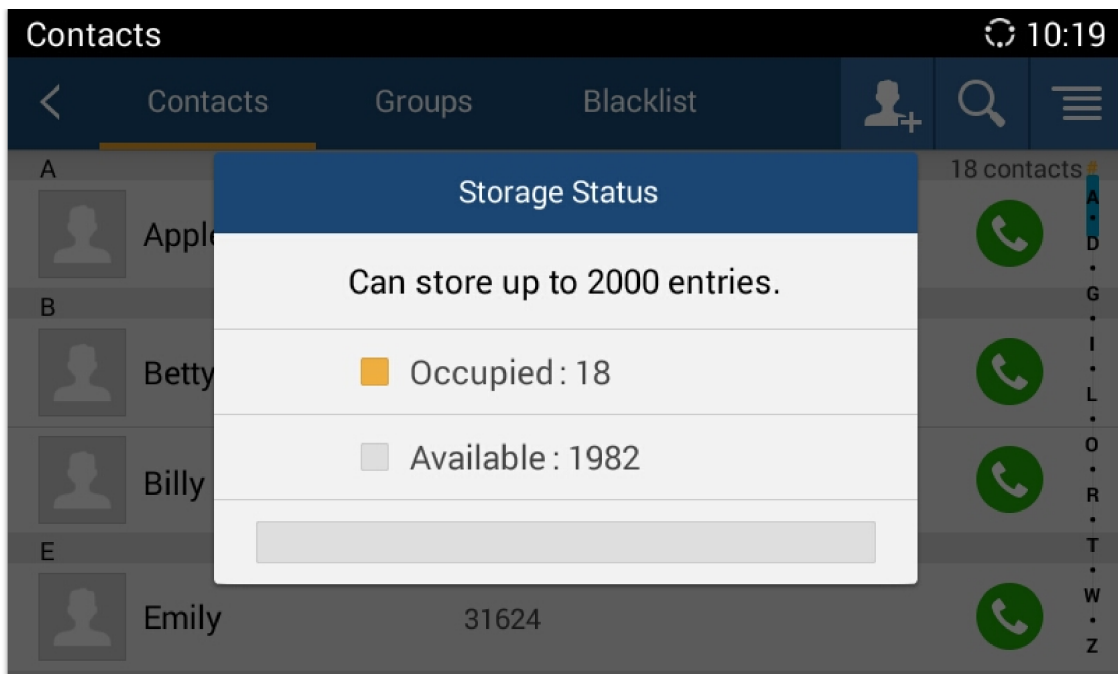

GAC2500 Contacts Storage Status Screen

- o **Add Google Account**

Account allows users to add vast number of 3rd party Android applications (including Google, Lync, Skype, company, Email, and etc.). Users can also sync GAC2500 via Google Play account, corporate account or Email.

Tap "Add Account" button to add new account according to the installation wizard.

The following steps demonstrate how to add a Google account.

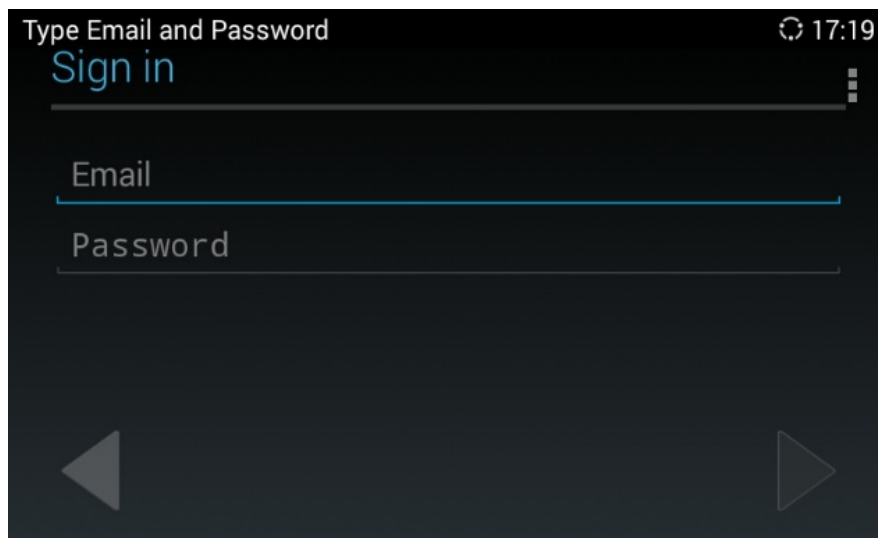
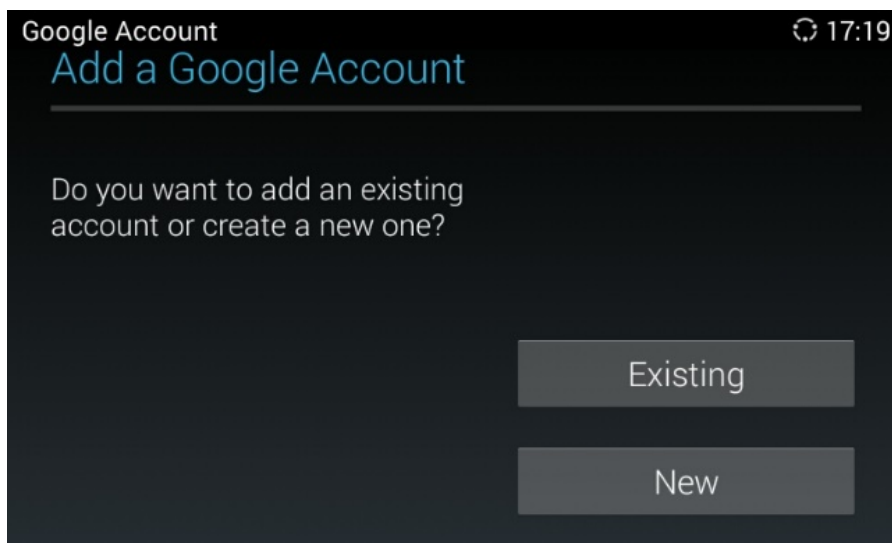

Groups

Users could divide contacts into different groups with specific names. Tap on one group entry to view group details.



GAC2500 Groups Screen

o Add New Group

There are 2 ways to add group members.

- o Add the contact to the group when editing or adding a new contact.
- o Select the contact you would to add to this group on Groups page when adding or editing a new group.

Follow the steps below to create a new group:

1. Tap on  the Groups page as shown below;

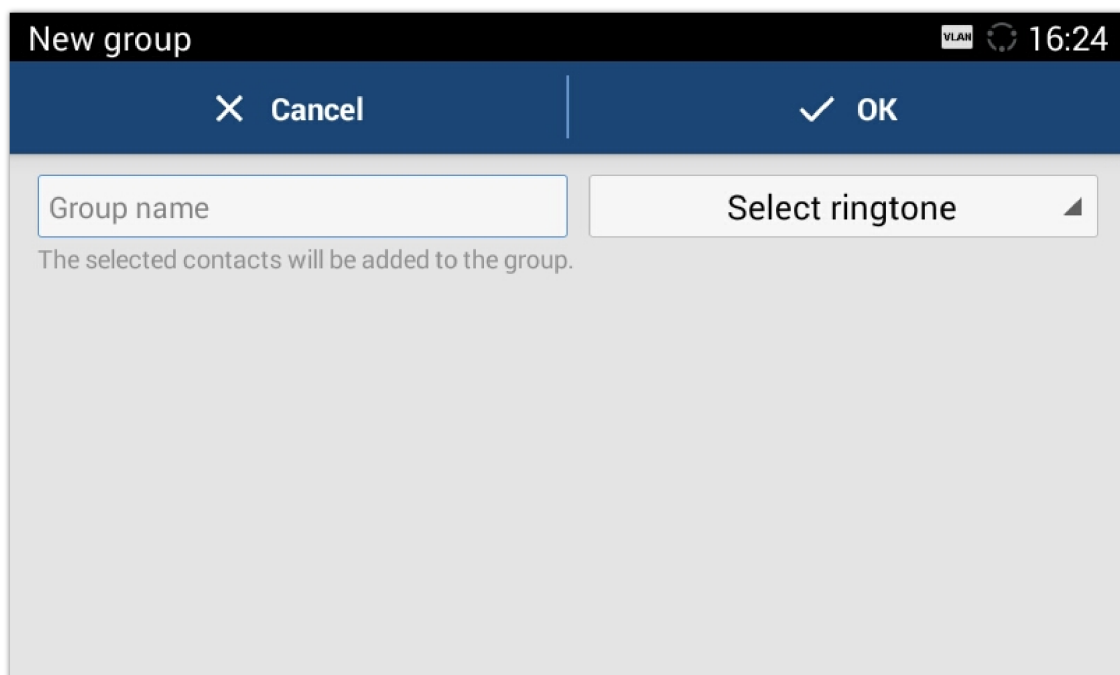

GAC2500 Add Group Screen

Note

The priority of ringtones from high to low is "Custom", "Group", "Account" and "Default". If one group has set the custom ring for its contacts, the phone will ring the custom ringtone other than other group ringtones.

Call Groups

1. Tap on  the upper right corner on Groups screen to access screen as shown below:

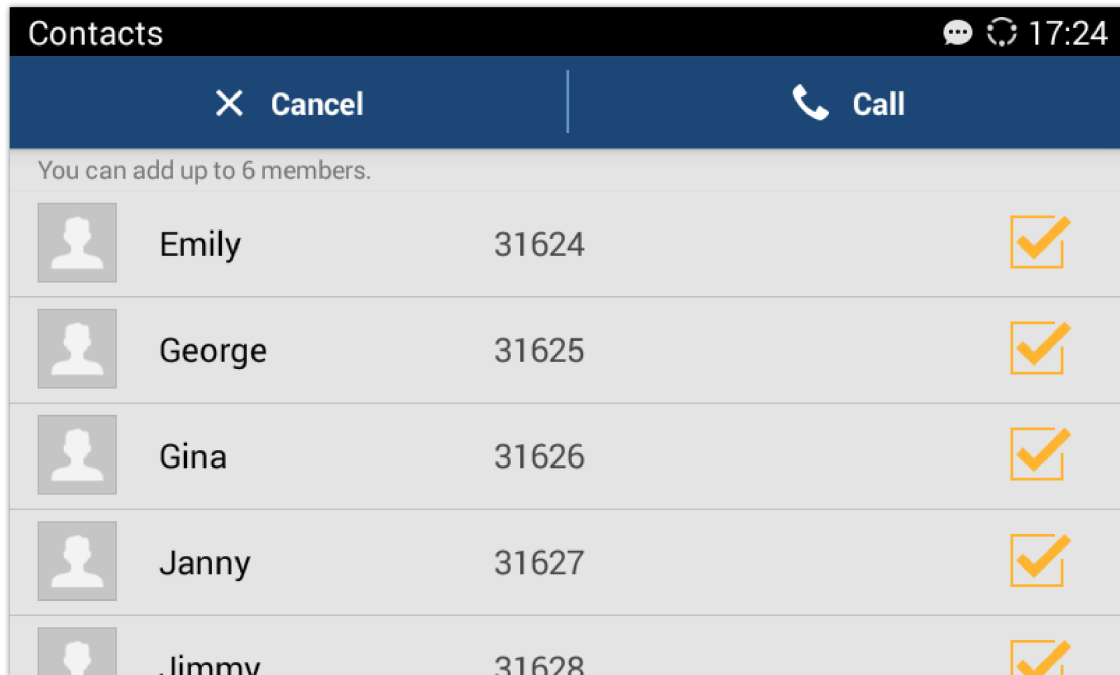

GAC2500 Dial Group Members Screen

2. Check group member (s) you want to call;
3. Tap on the CALL button to dial out.

o Delete Group

Follow the steps below to delete groups.

1. Long press the group entry you want to delete; the screen is shown below:

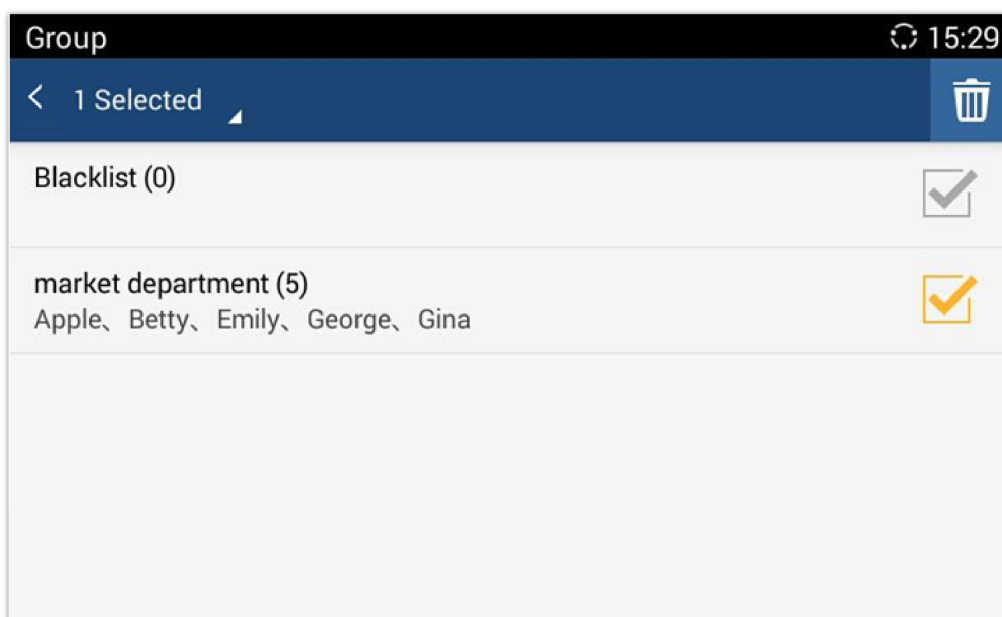

GAC2500 Edit Group Screen

2. Check to select the group (s) you would like to delete;
3. Tap on  the upper right corner to delete.

- o **Create Group Short Cut**

GAC2500 supports creating a shortcut of a group to LCD desktop, or to Group Call in hotkeys app.

1. In Groups tab under Contact app, tap on one group item to enter edit detail.
2. Tap on the send icon  to prompt modes to select.
3. Check the mode to send and tap "OK".

Note

When choosing "Send to the Group Call (hotkeys)" but the group has more than 6 contacts, please choose at most 6 numbers.

Blacklist

Blacklist helps users to block calls from blacklist at the same time does not affect normally answering other incoming calls.

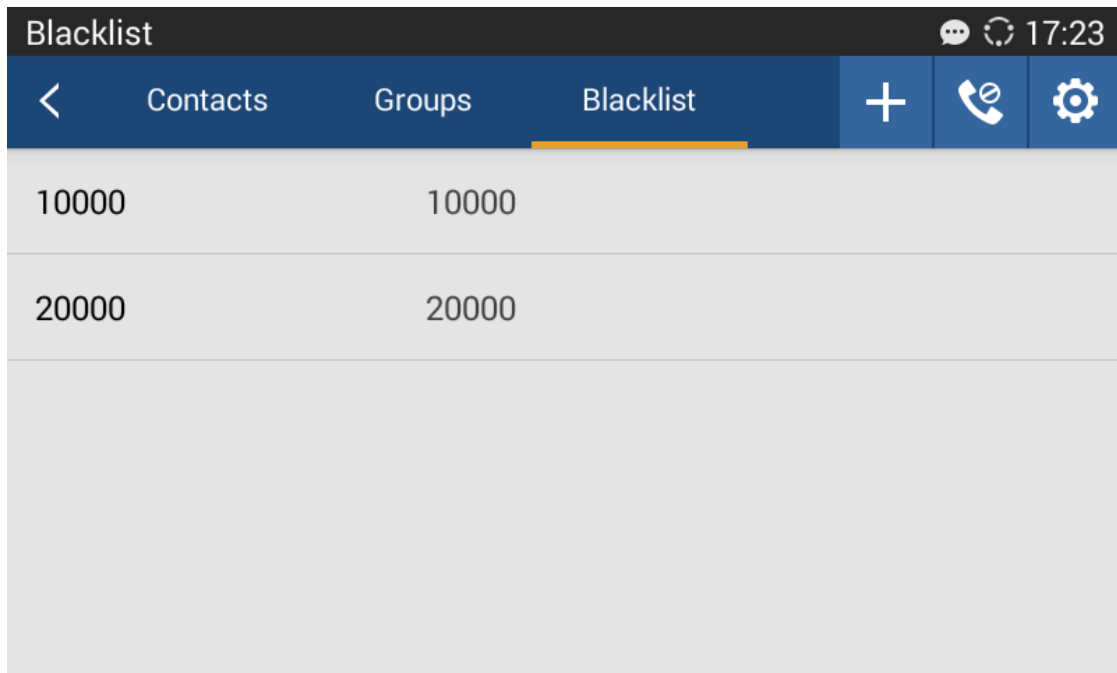

GAC2500 Blacklist Screen

 Display blocks history.

 Tap to add number to blacklist. There are 3 ways to add number: Manually add, add from contacts, Add from call history. Select one way and tap on "OK" to add the corresponding number to blacklist.

Long press one blacklist log to enter the editing mode to edit or delete the selected contact (s). Users could edit the blacklist entry when only one is selected.

 Blacklist Settings.

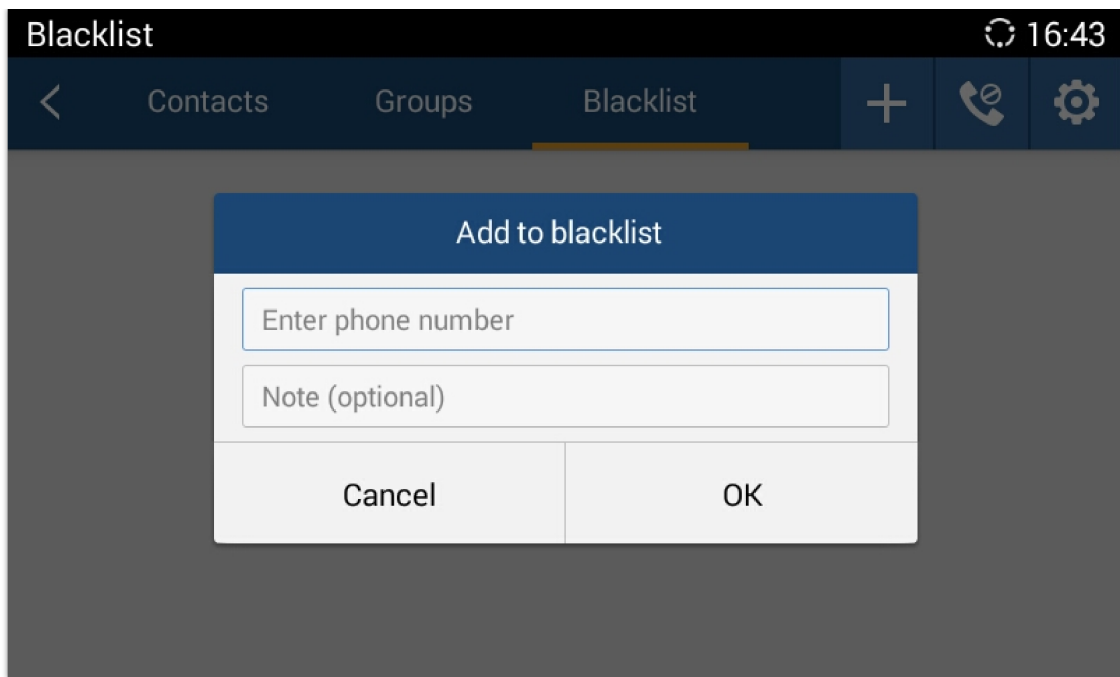

GAC2500 Manual Add Blacklist Screen

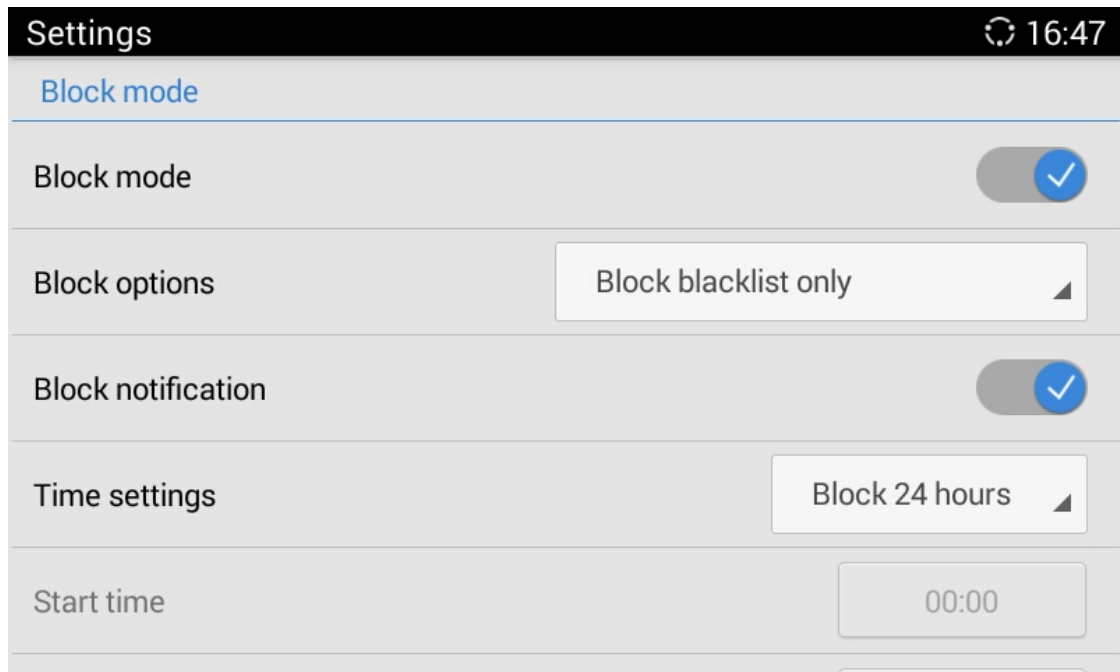

GAC2500 Blacklist Settings Screen

Parameters	Descriptions
DND mode	Turn on/off DND mode. Once it's turned on, the phone would reject all incoming calls.
Block mode	Turn on/off Block Mode. Once it's turned on, the incoming calls from the numbers in the blacklist will be rejected.
Block options	Set the types of incoming calls. This option is valid once the Block Mode is turned on.
Block notification	Set up whether to notify the user after blocked calls. Once it's turned on, the block icon will be displayed in the status bar after the device blocked calls. Users could go to the notification bar to view details. 

Time settings	Set up the block schedule.
---------------	----------------------------

GAC2500 Blacklist Settings Parameters

LDAP

GAC2500 supports LDAP. Tap on LDAP Contacts to access the main interface as shown below:

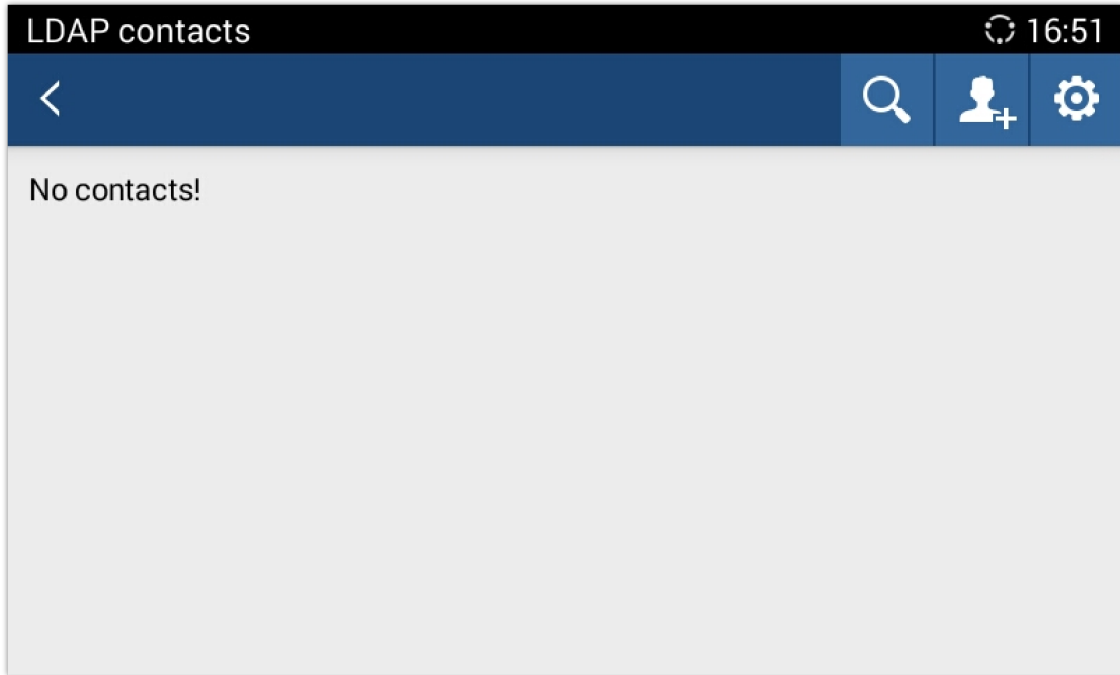

GAC2500 LDAP Book Screen

Tap on  the upper right corner or login the Web page to configure it. (Maintenance → LDAP Book).

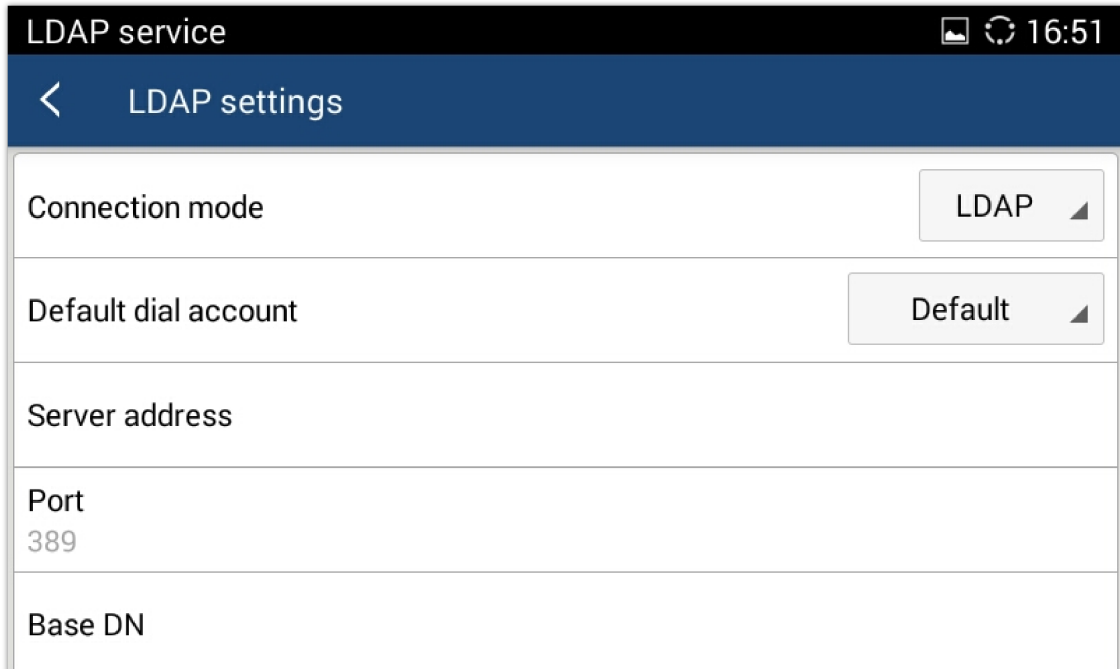

GAC2500 LDAP Settings

Parameters	Descriptions
Connection mode	Selects which protocol will be used for LDAP searching, LDAP or LDAPS.
Default dial account	Specifies default account when making outgoing from LDAP contacts.

Server address	Configures the URI of the LDAP (Lightweight Directory Access Protocol) server.
Port	Configures the LDAP server port. The default LDAP port number is 389.
Base DN	Determines the LDAP search base. This is the location in the directory where the search is requested to begin. Example: dc=grandstream, dc=com ou=Boston, dc=grandstream, dc=com
User name (binding DN)	Configures the bind "Username" for querying LDAP servers. Some LDAP servers allow anonymous binds in which case the setting can be left blank.
Password	Specifies the bind "Password" for querying LDAP servers. The field can be left blank if the LDAP server allows anonymous binds.
LDAP name attributes	Configures the "name" attributes of each record which are returned in the LDAP search result. This field allows the users to configure multiple space separated name attributes. Example: gn cn sn description
LDAP number attributes	Configures the "number" attributes of each record which are returned in the LDAP search result. This field allows the users to configure multiple space separated number attributes. Example: telephoneNumber telephoneNumber Mobile
LDAP mail attributes	Determines the "mail" attributes of each record which are returned in the LDAP search result. Example: mail
LDAP name filter	Configures the filter used for name lookups. Examples: ((cn=%)(sn=%)) returns all records which has the "cn" or "sn" field starting with the entered prefix; (!(sn=%)) returns all the records which do not have the "sn" field starting with the entered prefix; (&(cn=%)(telephoneNumber=*)) returns all the records with the "cn" field starting with the entered prefix and "telephoneNumber" field set.
LDAP number filter	Defines the filter used for number lookups. Examples: ((telephoneNumber=%)(Mobile=%)) returns all records which has the "telephoneNumber" or "Mobile" field starting with the entered prefix; (&(telephoneNumber=%)(cn=*)) returns all the records with the "telephoneNumber" field starting with the entered prefix and "cn" field set.
LDAP mail filter	Determines the filter used for mail lookups. Example: (mail=%)(!(sn=%)) returns all the records which do not have the "sn" field starting with the entered prefix. (&(cn=%)(telephoneNumber=*)) returns all the records with the "cn" field starting with the entered prefix and "telephoneNumber" field set.
LDAP displaying name attributes	Configures the entry information to be shown on phone's LCD. Up to 3 fields can be displayed. Example: %cn %sn %telephoneNumber

Max hits	Specifies the maximum number of results to be returned by the LDAP server. If set to 0, server will return all search results. The default setting is 50.
Search timeout (s)	Configures the interval (in seconds) for the server to process the request and client waits for server to return. The default setting is 30 seconds.
LDAP lookup when dialing	Sets the phone system to do the LDAP number searching when making outgoing calls. The default setting is “No”.
Search LDAP for incoming call	Sets the phone system to do LDAP number searching for incoming calls. The default setting is “No”.

GAC2500 LDAP Book Parameters

Once configured, you can tap on Search button  to input digits or name to search LDAP contact as shown below.



GAC2500 Web GUI Maintenance – LDAP Book

 Dial out.

 Add the LDAP contact to local Contacts.

Follow the steps below to batch add LDAP contacts:

1. Search LDAP contacts;
2. Tap on  to access add contact screen as shown below:

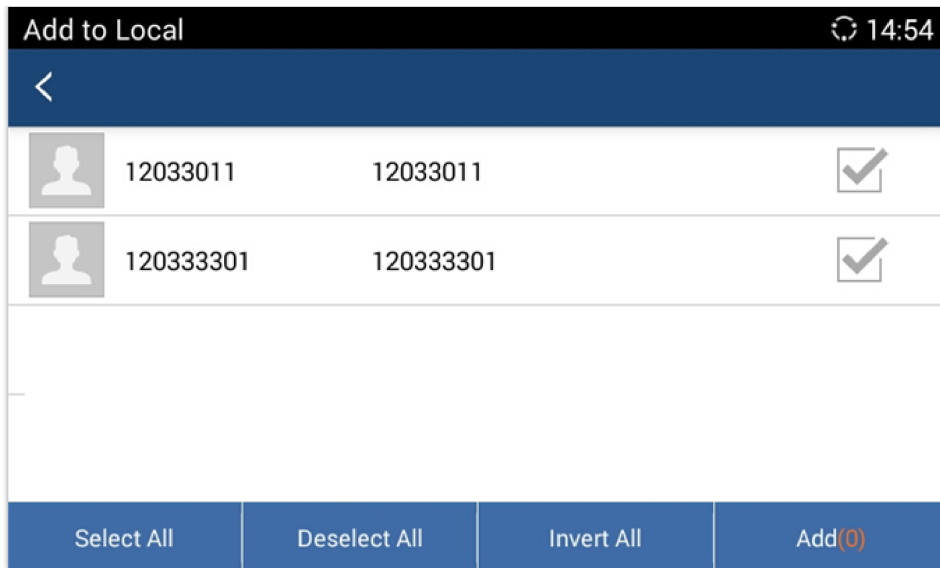

GAC2500 Add LDAP Contact to Local

3. Check contacts entries to add contacts to local.

Broadworks XSI Contacts

Besides the Local and LDAP phonebook, the GAC2500 also supports BroadWorks Xsi contacts if BroadWorks XSP server is available within the network. *For more details about Broadworks XSI Contacts, Please, refer to GAC2500 Administration Guide.*

Call History

Call History provides users access to phone's recent call records. The user can view all records, or select different categories for incoming calls, outgoing calls, missed call and conference.

To access Call History, go to Home screen → Applications → .

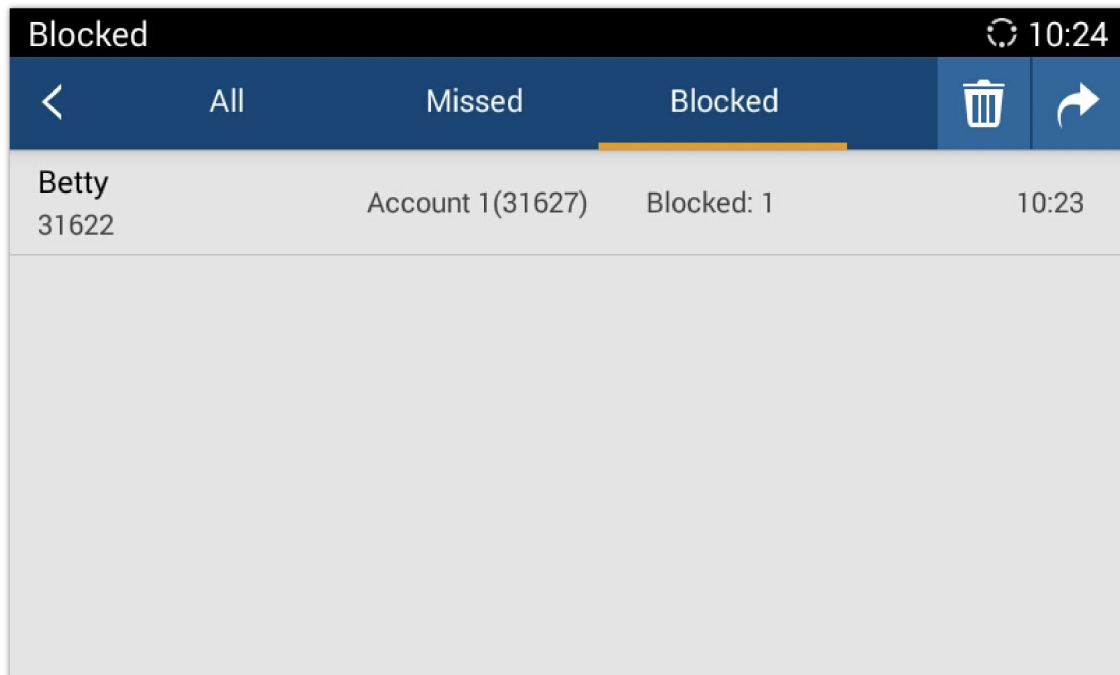

GAC2500 Call History Screen

Click on a record in the call history and press  to dial out this number directly. Tap one history entry to view call details for this number.

All		Missed		Blocked		🗑️	
👥	market meeting	10:16					📞
👤	Betty 📞 31622	10:13					📞
👤	Sam 📞 31629	10:08					📞
👤	*5 📞 *5	09:12					📞
👤	35622 📞 35622	09:14					📞
		11/25					📞

GAC2500 Call History Details

Note

Call history displays all Blue Jeans™ conference call history as well. Tap on  to dial out directly and there is no need to input the password again. However, if the conference doesn't exist or the password has been changed, the re-dial will fail.

Call Count Call History

Users can view number of calls made or received from one extension by following these steps:

1. Access Call History

All		Missed		Blocked		🗑️	
20 call record(s)							
👤	1004 (11) 📞 1004	06:52					📞
👤	10004 📞 10004	06:08					📞
👥	1001,1002,Mhammed	06:06					📞
👥	1002,1001,1004	05:46					📞

Call History Count

2. Select one call history entry to access details of the call.

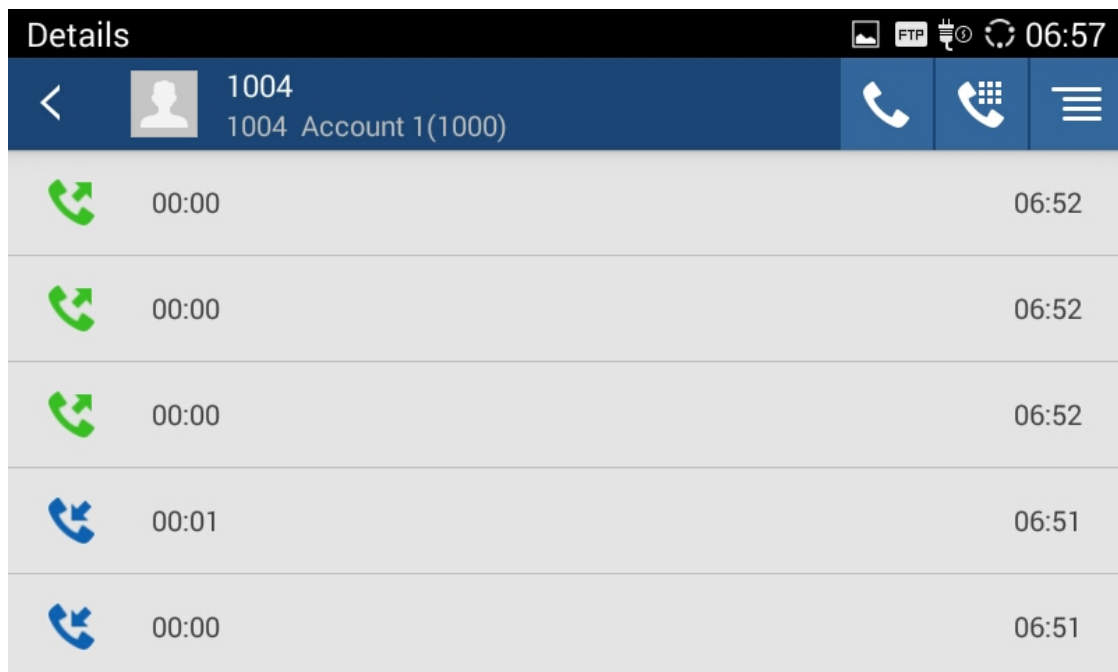

Call History Count Details

Add Contact from Call History

1. Access Call History screen;
2. Select one call history entry to access details screen;
3. Tap  on the upper right corner and select "View contact" to access "Add a contact" screen;

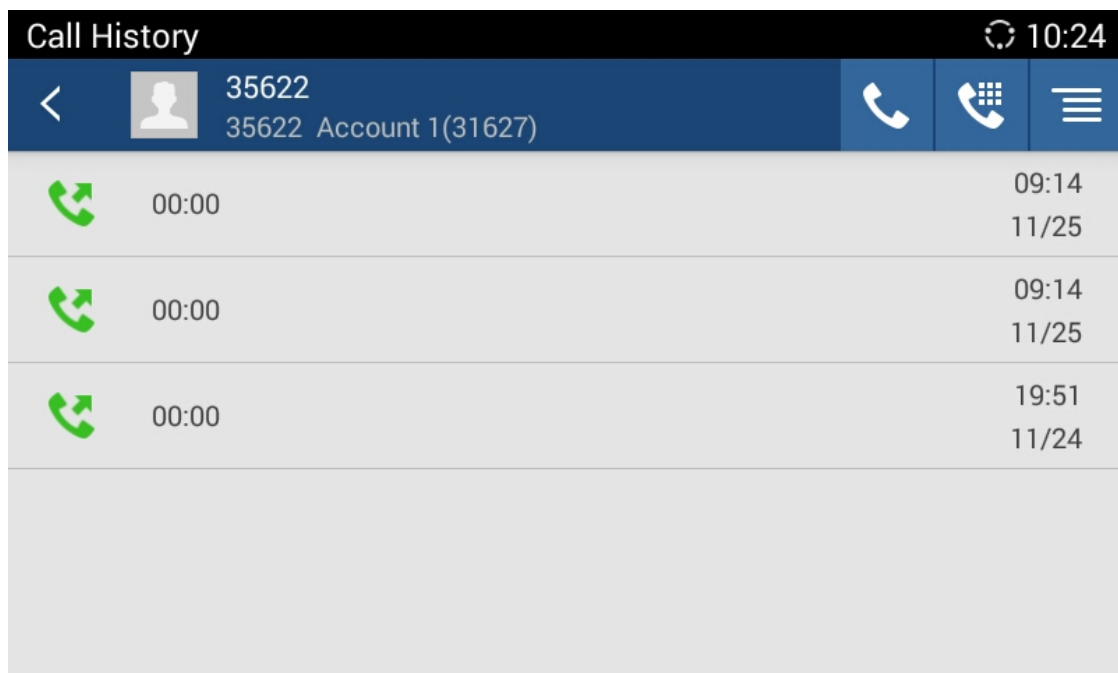

GAC2500 Add Contact Screen

1. Tap on "Create new contact" to add new contact information.
2. Confirm to add contacts.

Delete Call History

1. Long press the call history entry you want to delete to access editing mode;
2. Check the entry and tap on , click "OK" to delete.

Schedule Conference via Call History

1. Select one call history entry you would like to add to scheduled conference;

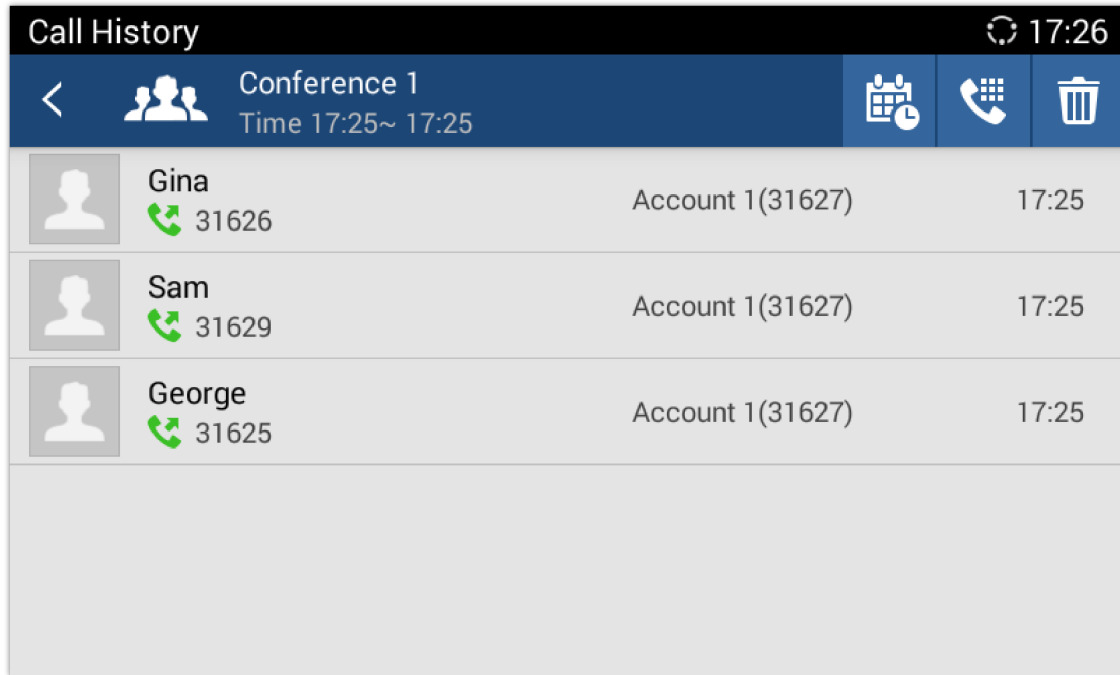

GAC2500 Conference Call History Screen

2. Tap  on the upper right corner to access schedule screen.

3. Fill in information and tap on  to save.

Note

If the conference members are more than 6 people, you will enter the members select screen to check members first.

Intercepted History

When the incoming call is from contact in blacklist, the GAC2500 will reject it automatically. The screen is as shown below.

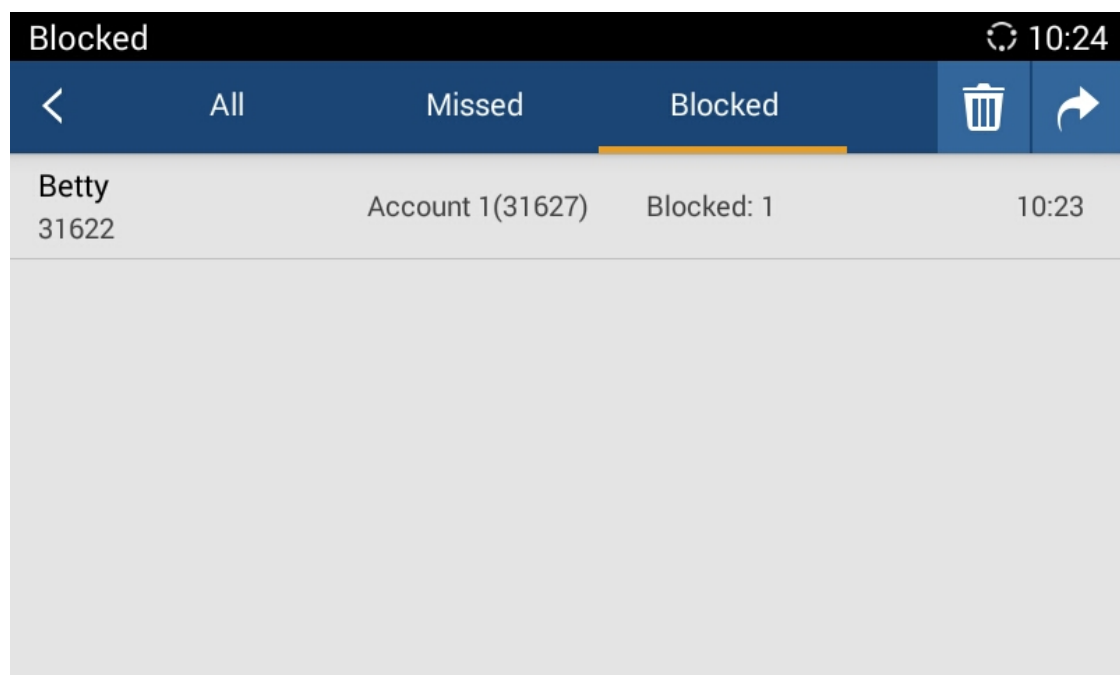



GAC2500 Intercepted History Screen



Empty intercepted history.

 Restore to be the contact.

Hotkeys (MPK)

1. User could login the Web page and go to Advanced→MPK LCD Settings or go to LCD menu→Hotkeys to configure it.
2. Open Hotkeys app from LCD menu, tap on  the upper right corner to access Number List page. Tap on  to add number.
3. Users could also tap on  to add number directly from Contacts. See figure below.

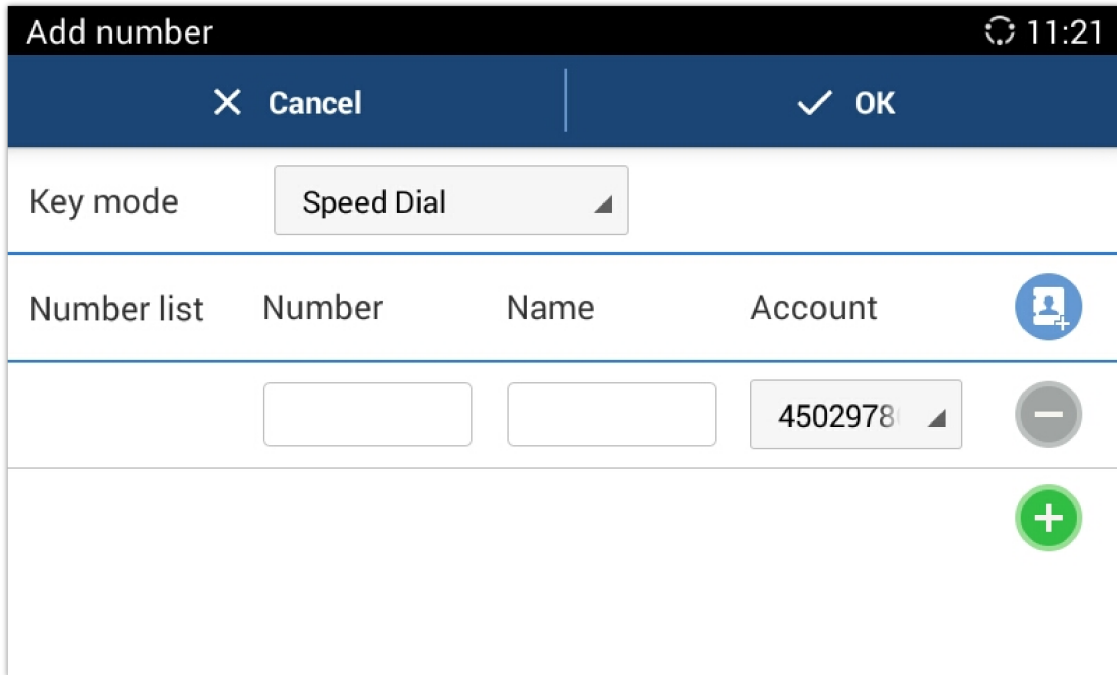

Number list	Number	Name	Account
	<input type="text"/>	<input type="text"/>	4502978

GAC2500 Add MPK Number

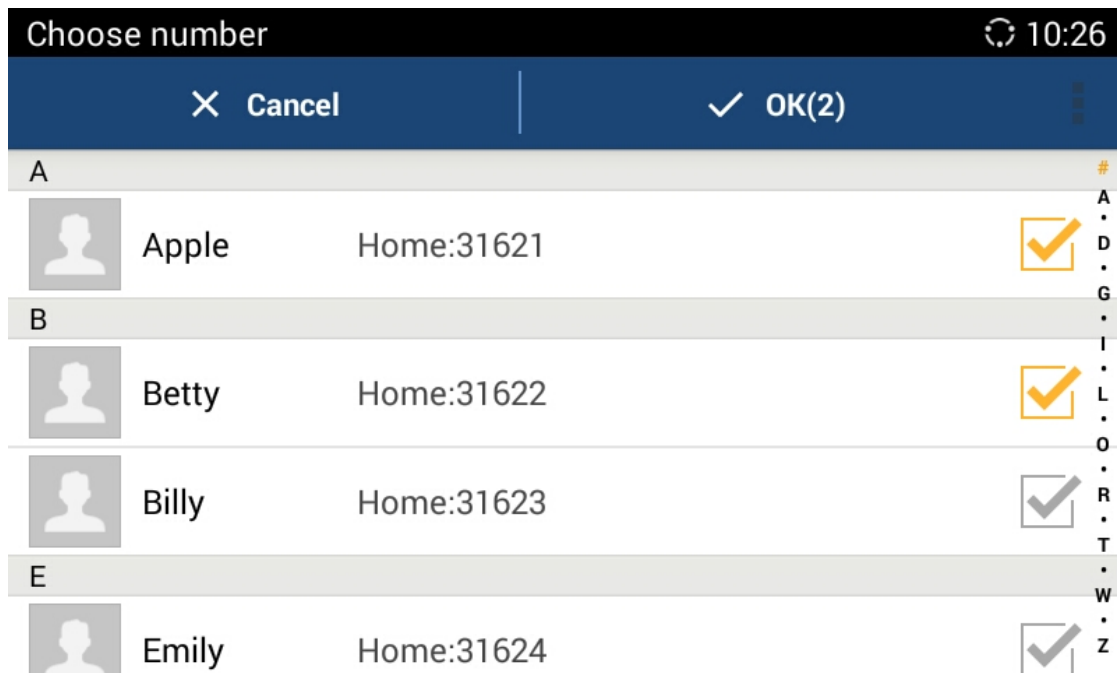

	Name	Phone Number	
A	Apple	Home:31621	<input checked="" type="checkbox"/>
B	Betty	Home:31622	<input checked="" type="checkbox"/>
	Billy	Home:31623	<input checked="" type="checkbox"/>
E	Emily	Home:31624	<input checked="" type="checkbox"/>

GAC2500 Add Number from Contacts

4. The MPK screen is shown in figure 76 after adding numbers.

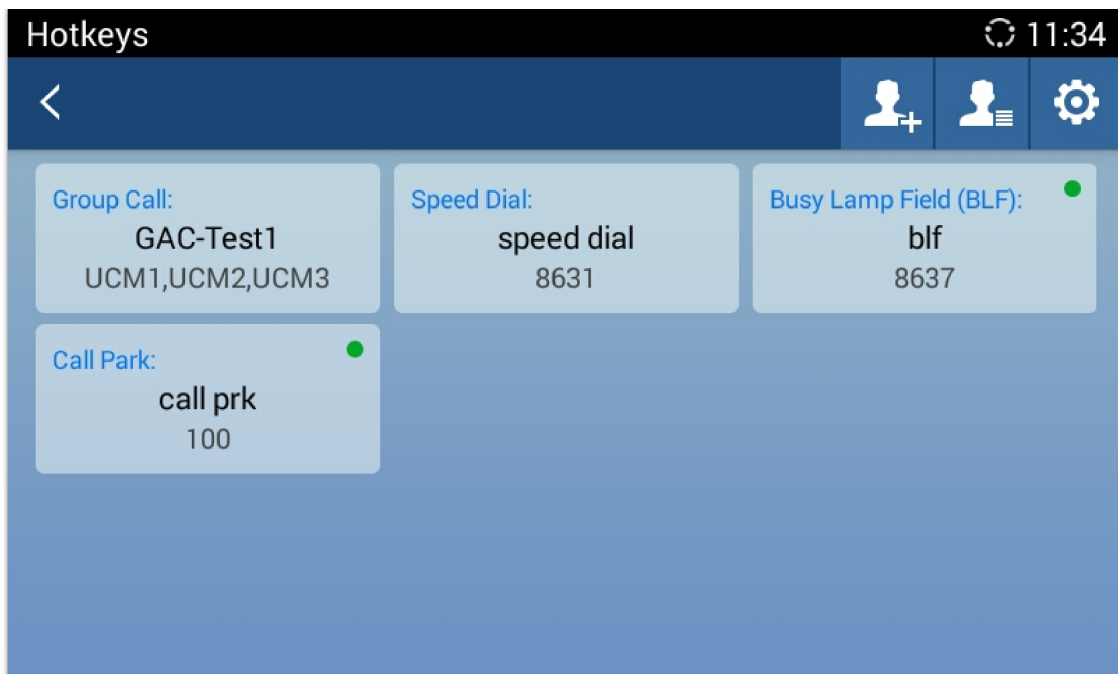

GAC2500 MPK Number Screen

Event list

The Event List URI in MPK list, it requires server support. Users should firstly configure an Event List URI including expanded list on the server (e.g.: BLF1006@myserver.com) and fill in URI without a domain name (e.g.: BLF1006).

1. Open MPK, tap on  on the upper right corner and select Event list as key mode.
2. Fill in information and save.

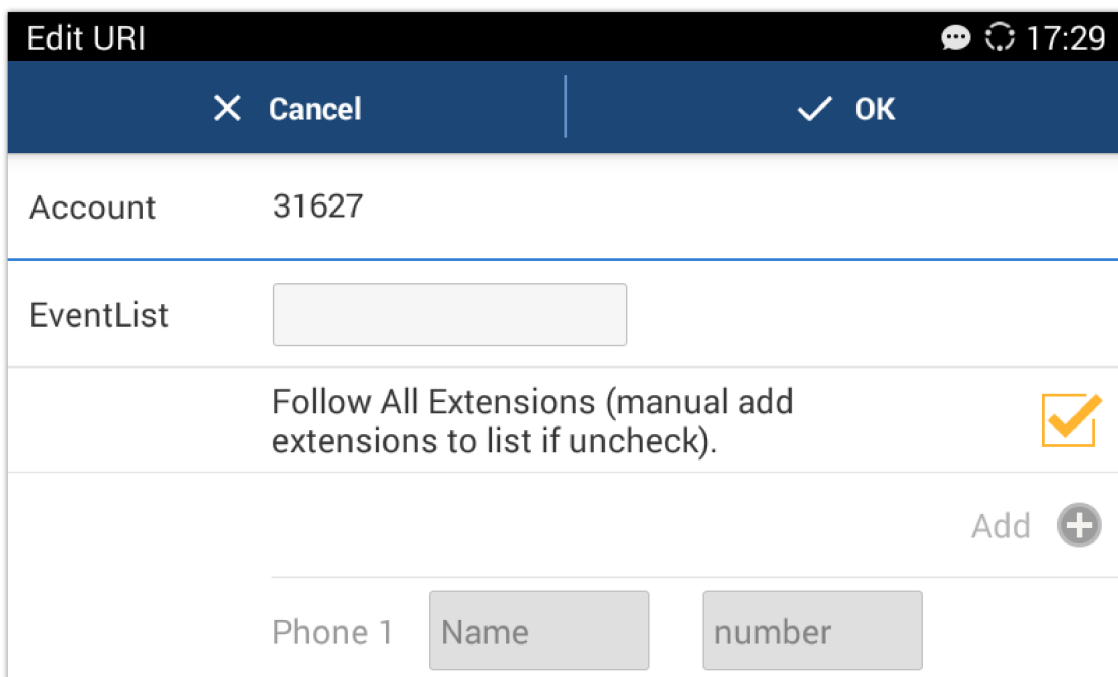

GAC2500 MPK URI Screen

MPK List

Open Hotkeys(MPK), select  on the up-right corner to enter MPK list, shown as below.

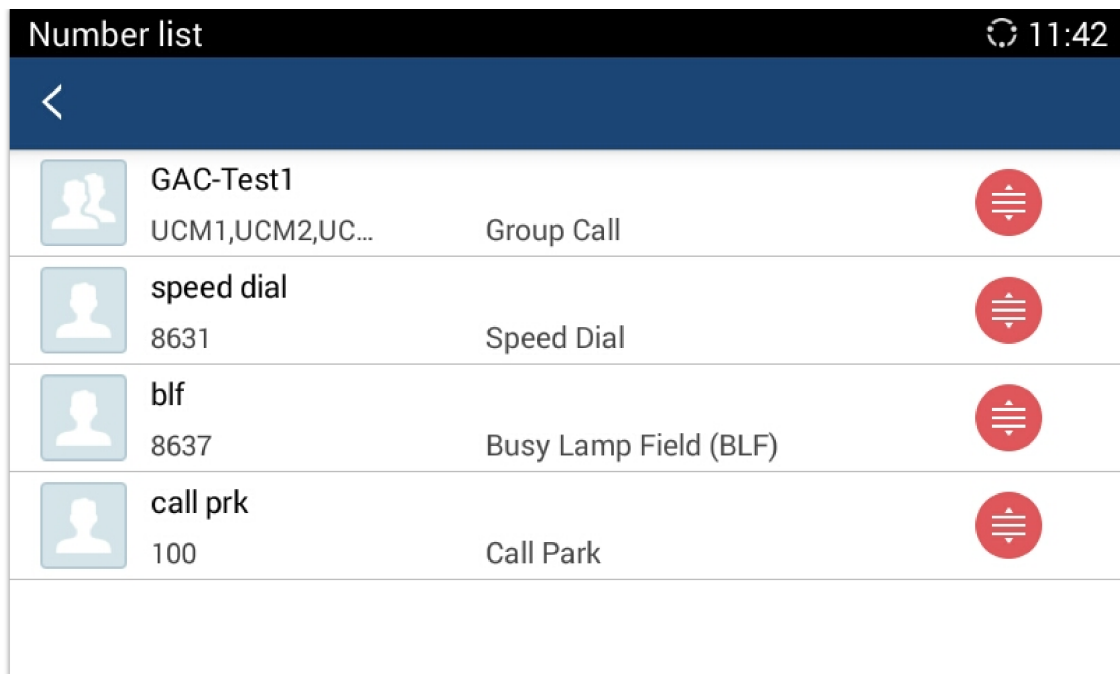

GAC2500 MPK List

Users can edit, order or delete the hotkeys in the list.

Edit: Click on an item to enter the edit page.

Order: Hold the  on the right and move the item to reorder.

Delete: Hold the item to enter selection page, then check one or more items to delete

MPK Settings

Tap on  the upper right corner on MPK screen to access Settings screen as shown below:

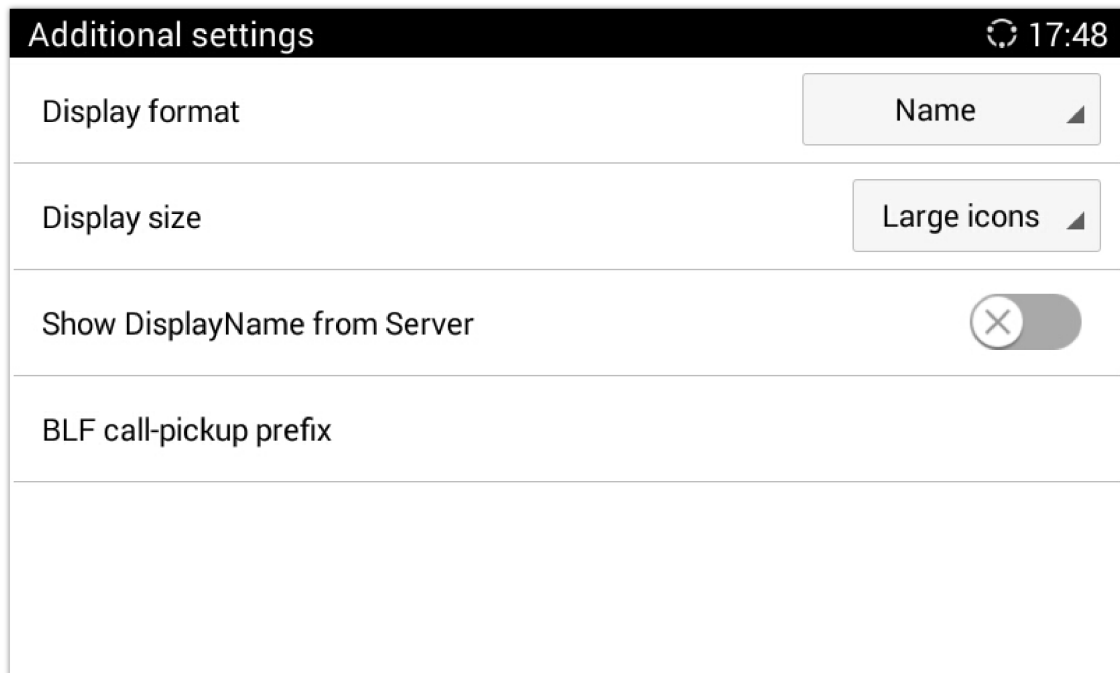

GAC2500 MPK Settings Screen

Parameters	Descriptions
Display format	Configures the display format for the MPK. The default setting is "Name".

Display size	Configures the display size for the MPK. The default setting is “large icons”.
Show Display Name from server	If selected, the display name on the server will replace the name users configured. The default is “No”.
BLF call-pickup prefix	If configured, the phone will add the prefix each time using MPK button to answer the call. The default setting of each account is “***”.

GAC2500 MPK Settings Parameters

Notices

Users could receive SIP messages and set up reject calls in Notices function. The Notices page is as shown below:

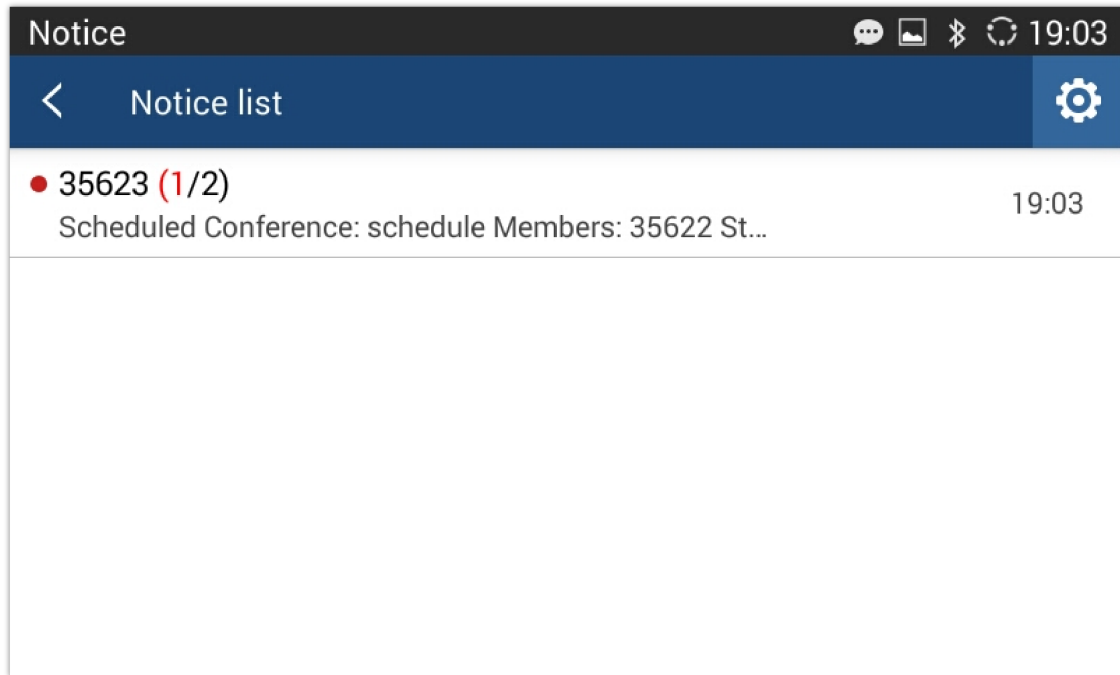

GAC2500 Notices Screen

View Notices

The Notices page displays notices list, the notices are classified by contacts name or phone number and sorted by the time when you received notices. Tap on one notice entry to view details.

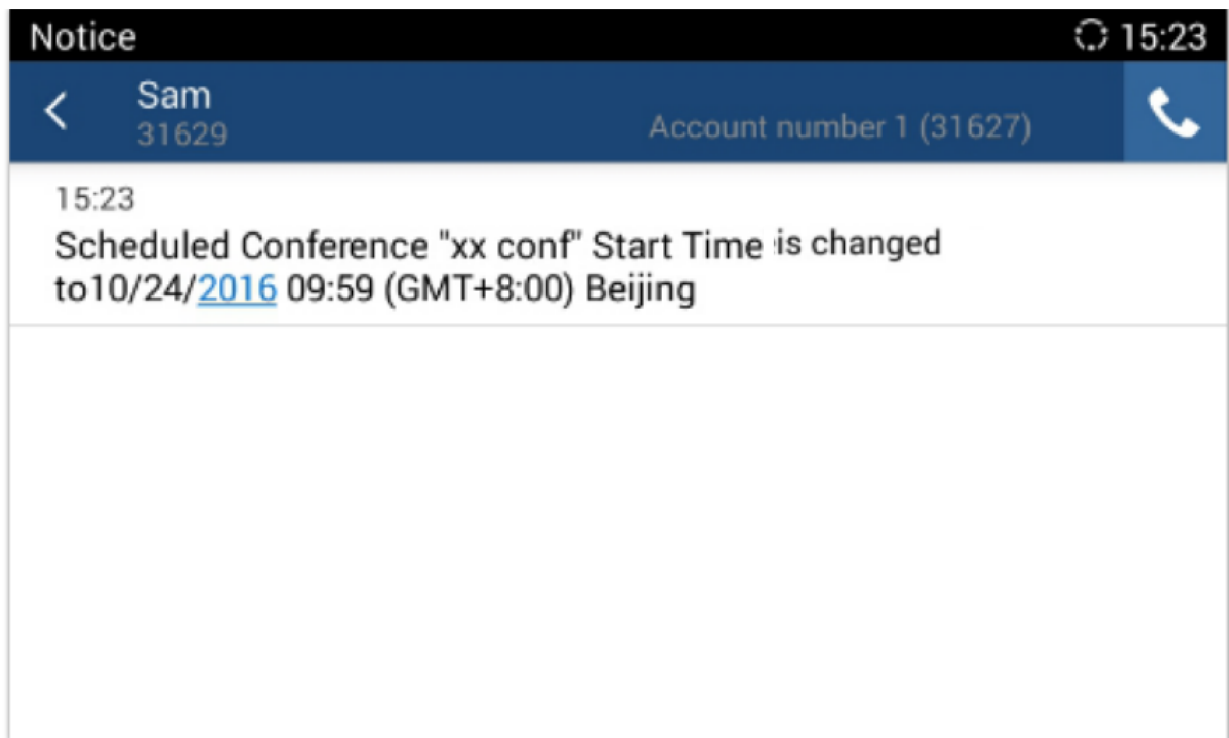

GAC2500 View Notices

Delete Notices

1. Long press one notice entry to access edit screen;
2. Check the notice (s) you want to delete and tap on  to delete.

Notices Settings

If enable "Allow Reminder", a warning will be sounded and you'll see notification on the status bar when receiving a notice; If enable "Quick Reply", a quick reply will be sent when the incoming call is rejected.

1. Tap on  the upper right corner on Notices page to access Settings screen;

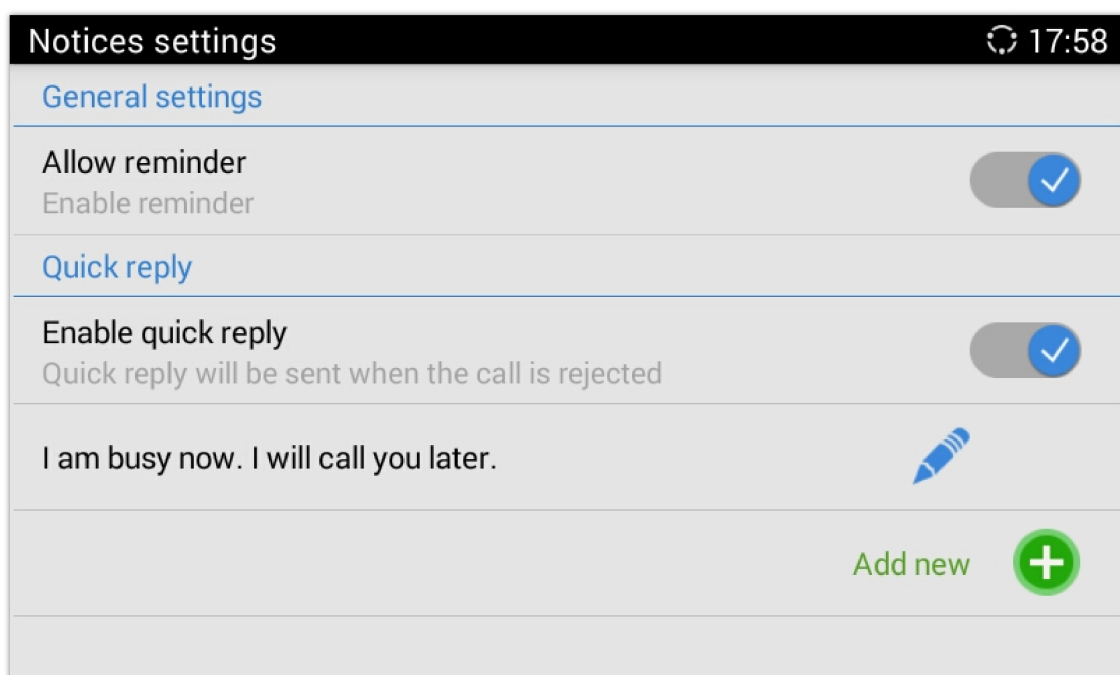

GAC2500 Notices Settings Screen

2. Enable quick reply and add reply content;

3. When there is an incoming call, the screen is as shown below:

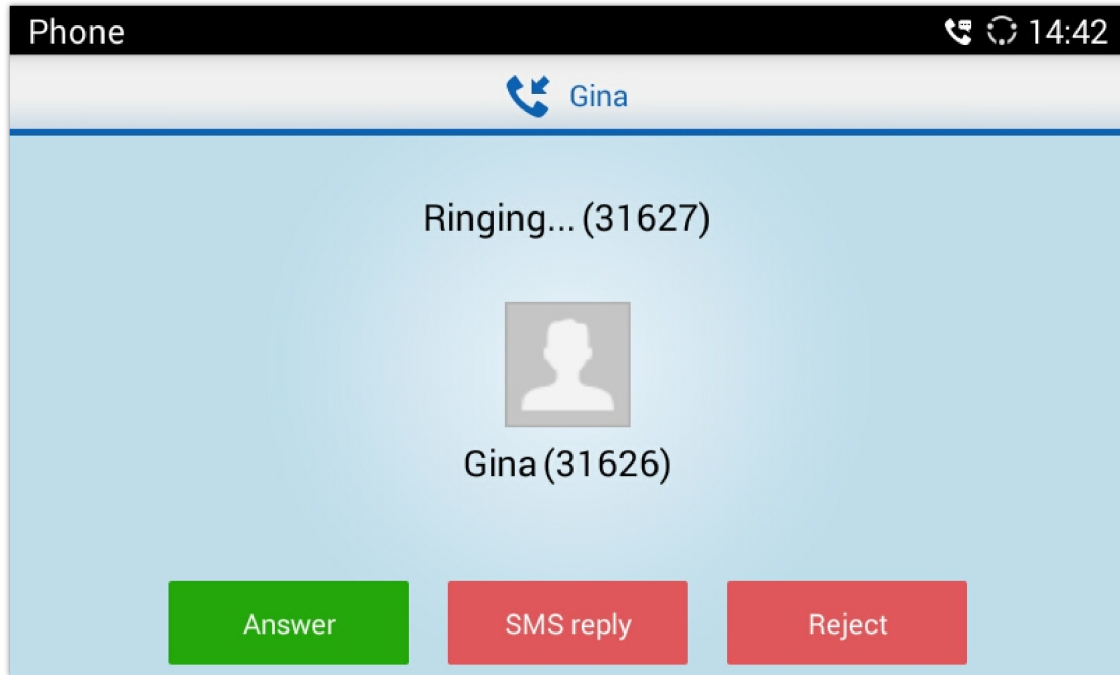

GAC2500 Incoming Call Screen

4. Tap on "SMS Reply";

5. Select one reply to send, the call will be rejected and the caller will receive the message.

File Manager

File Manager allows users to delete, move, copy, paste, send, rename files (including files on storage device such as USB flash drive), and query file properties on the GAC2500.

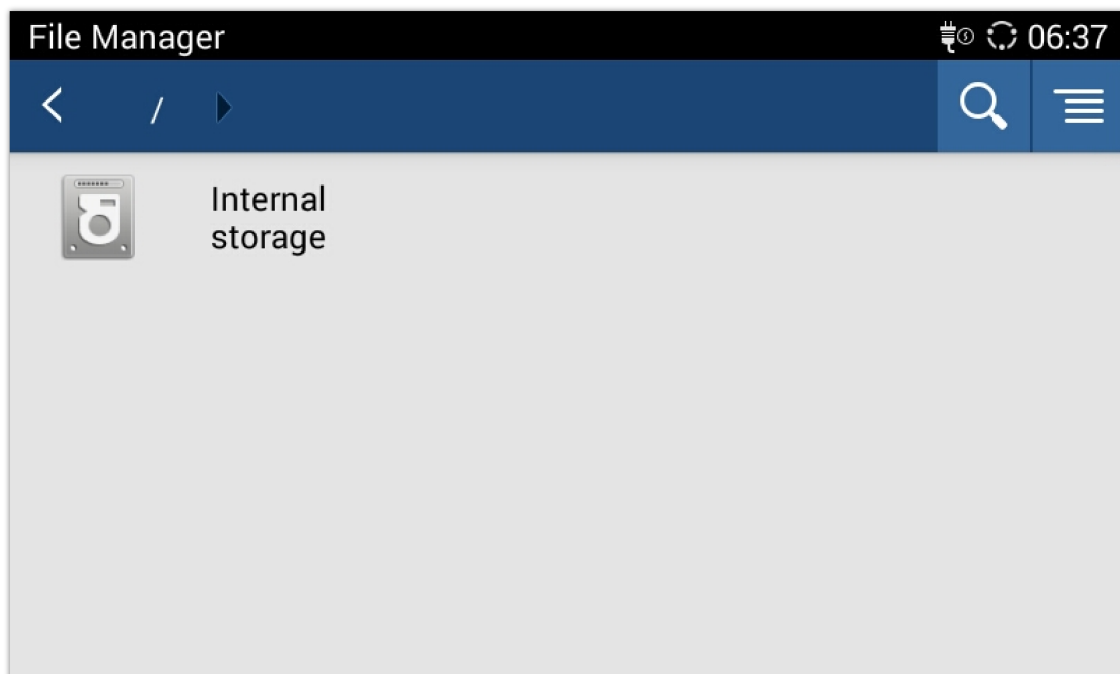



File Manager

Copy File

To copy the file from the GAC2500 to USB storage device:

1. Insert USB/SD storage device into USB port on the GAC2500. It will take a few seconds for the GAC2500 to prepare the connection;

2. The USB storage icon will show on the status bar;
3. Go to Home screen, find the application File Manager;
4. Open the target folder;
5. Long press the file to select;
6. Tap on  the upper right corner to copy file and press  to go back to the upper level directory;
7. Select target storage device and go to the directory where the file will be pasted to paste the file.

Send File

The first 5 steps are the same as the ones in Copy File.

1. Tap on  the upper right corner select "Send" option;
2. Select target location and confirm to send file.

Note



If the user needs to send the file via Bluetooth, enable and connect Bluetooth device first. Otherwise, the interface will be redirected to the corresponding setting page to configure.

Delete File

The first 5 steps are the same as the ones in Copy File.

1. Tap on  the upper right corner, a dialog will pop up for users to confirm whether to delete the file or not.
2. Press the "OK" key to delete the file successfully.

Rename File

1. Go to Home screen, find the application File Manager.
2. Open the target folder and long press the file.
3. Press MENU key  on the upper right corner and select "Rename".
4. Input the new file name in the pop-up dialog and press the "OK" key to save, tap on "Cancel" or press  to cancel.

Recorder

Users could record conference, institution and personal notes via GAC2500 Recorder conveniently. There is no time limit to recording time and the larger the available storage capacity is, the longer the recording time is. Users could also find the recording file from a call in the recorder and listen to it.

Long press the recording files to access editing interface, tap on the MENU key  to make other operations to recording files like export, rename, and lock/unlock.

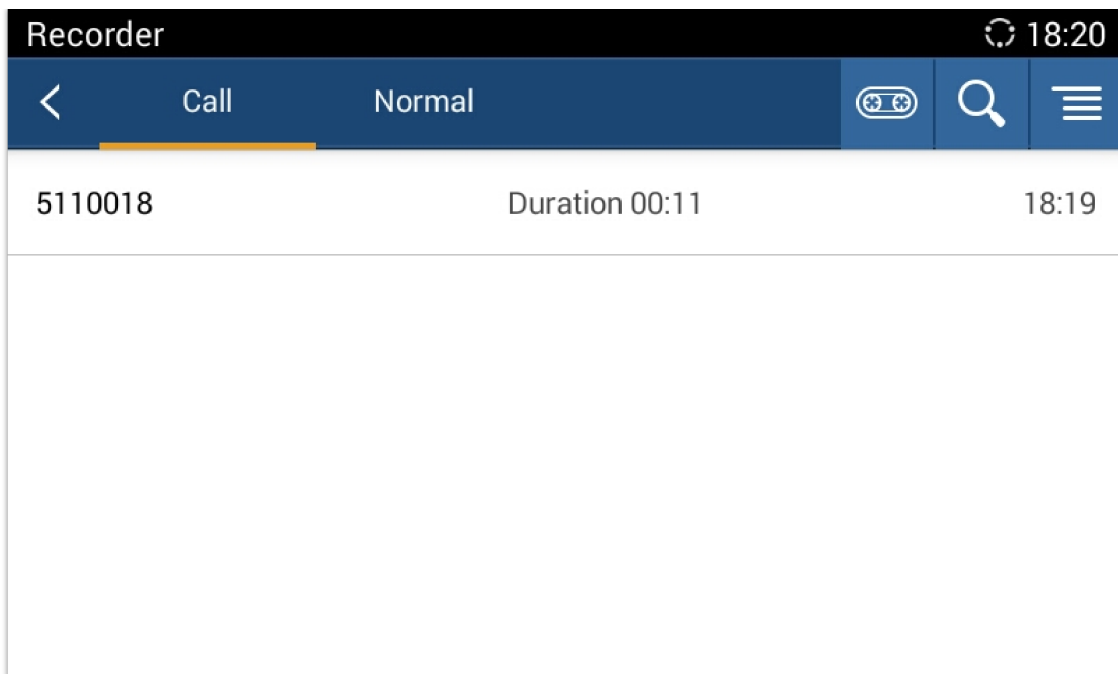



GAC2500 Recorder Main Screen

Note

If the USB storage is where recordings are written, the recording capacity depends on the USB storage space.

Normal Recorder

1. Tap on  the upper right corner to access recording interface, Tap on  to start recording;
2. Click "Save" to save the record file, click "Cancel" will bring out the dialog for users to confirm whether to save the file or not and to stop recording;

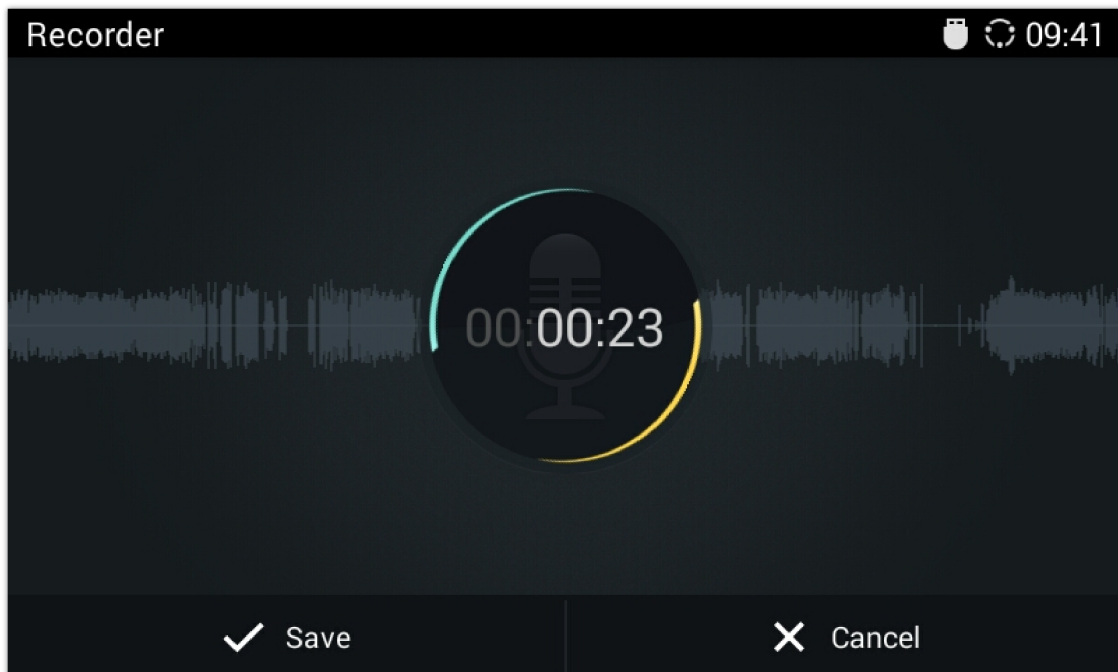

GAC2500 Normal Record – Recording

3. Go back to the Recorder page, select one recording file and click  on the right of the progress bar to play the file.

Call Recorder

In the process of an active call, the recording file will be saved on the phone. Users can only listen to it via Recorder.

Recorder		
Call	Normal	
31626	Duration 06:44	11:54
31626	Duration 02:45	10:22
31629	Duration 00:03	10/17 16:55

GAC2500 Call Recordings

Recorder Settings

Tap on  the upper right corner on Recorder screen to sort the recording files, or access the recording setting screen as shown below:

Recorder	
Security	
Enable password	<input type="checkbox"/>
Change password	
Recorder settings	
Not enough space for recording	Replace old recording ▾
Set maximum record space (MB)	300 MB

GAC2500 Recorder Settings Screen

- **Enable password.** Enable and set password. Once set the password, input the password to access Recorder.
- **Change password.** To change password, please enable "Enable Password" option first.
- **Set store location.** When a USB disk is detected, you can set the recorder stored in the USB disk.
- **Not enough space for recording.** Set "Replace Old Recording" or "Stop and Save" when there is no enough space for recording.
- **Set maximum record space (MB).** Set the maximum recording space on the device, you cannot view recording files via File Manager.
- **Set export location.** It can be an SD card or external export device.

Sound

User could set silent mode, increase GAC volume, Select Ring Tones and notification tones as well as selecting different voice mode from LCD under "Settings > Sound".

Diagnosis

Users could make operation like LCD Diagnosis, Keypad Diagnosis, and LED Diagnosis on GAC2500 by entering the feature code "***3424*" in the dial screen's keypad.

Browser

Users could browse webpage, view news and watch video via the built-in GAC2500 Browser. Press on  in the main menu to open Browser.

- Slide up and down with slide gesture to scroll the screen.
- Zoom in/out the page via zoom gesture.
- Press the menu button  on the upper right corner to open the menu bar for more operations.





GS Market

GAC2500 provides direct access to apps via built-in GS market app. Users could download the apps from the market and install to the GAC2500.

Search Apps

In the GAC2500 Home screen, click on Applications→GS Market . The users could view the apps by category, or input key words and click on  to search.

Download and Install Apps

- Users could see if the app has been installed or downloaded by pressing the blue shortcut key.
- Press MENU key  to view the downloaded apps and installed apps.
- Tap on  to cancel download in process.
- Tap on  to try again if the download failed.
- The installing process will be automatically started after downloading the app.
- Go to Installed screen to view the installed apps, or tap on  to uninstall the downloaded apps.

Update Apps

The GAC2500 will automatically detect if there is new version available for the installed apps to upgrade when the network connection is normal. User can view the relevant information and update apps on the Installed screen.

FTP Server

The GAC2500 supports file transferring via FTP Server app.

- Go to LCD menu and tap on  .

- Tap on Start FTP server to start the server.
- Go to PC browser and type in the address on LCD to manage the files from PC.

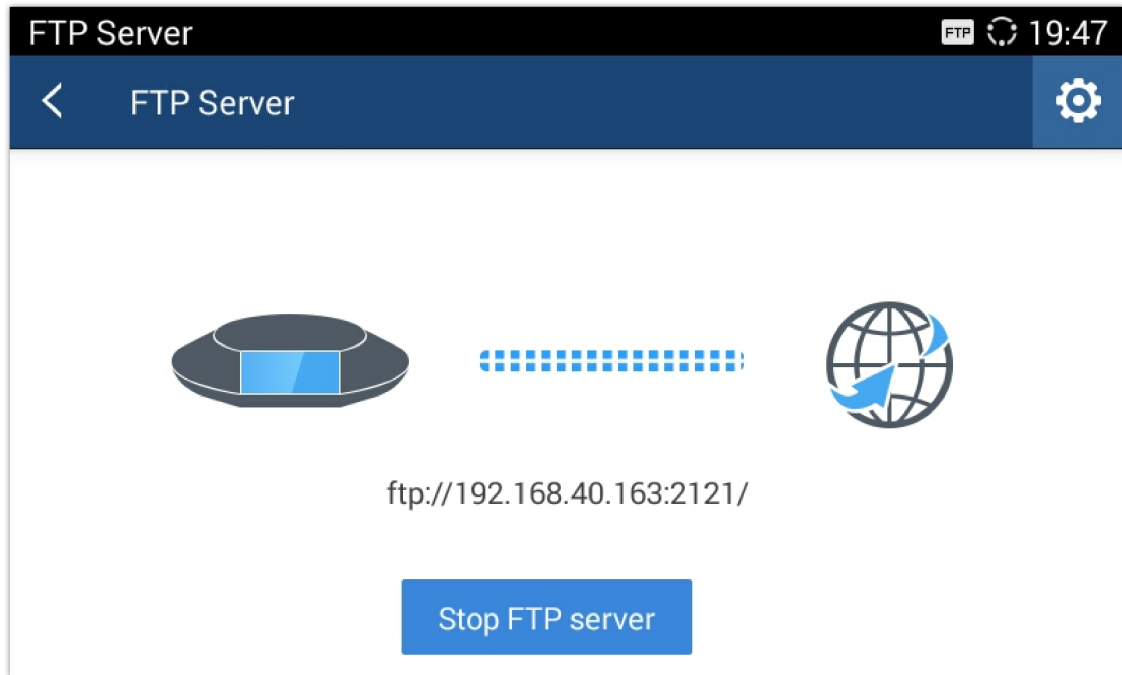

GAC2500 FTP Server Connection

You can change the settings of FTP server before file transfer. Tap on the  on up right to open FTP server settings. From here, user can set username and password to login, port number and directory to access.

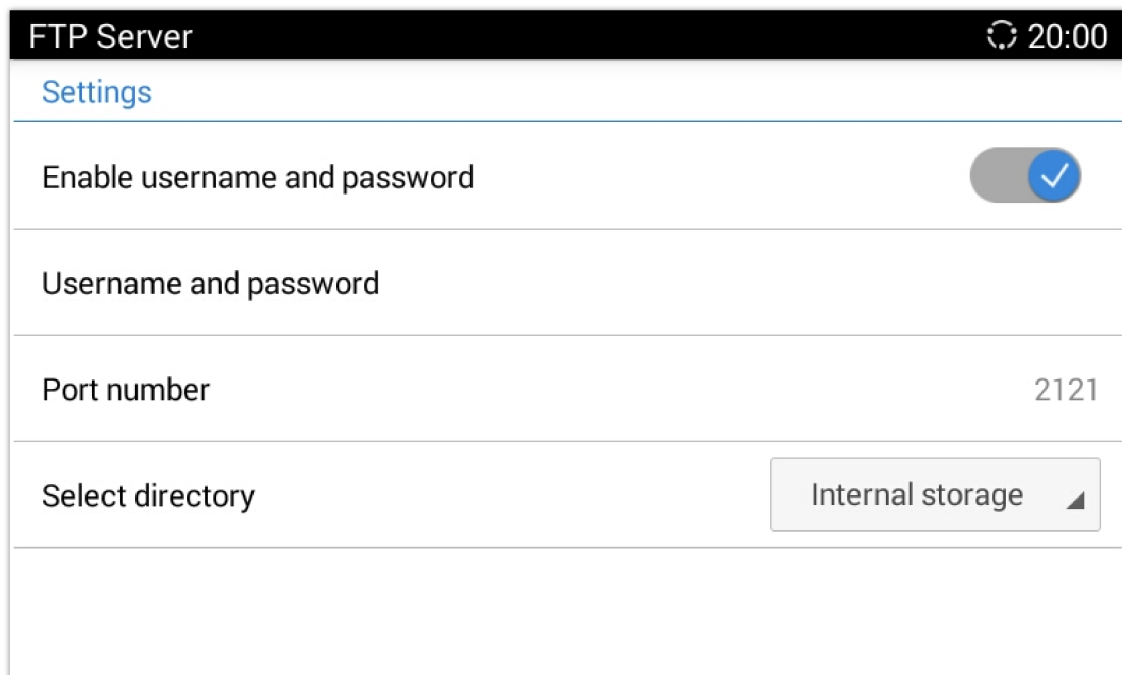

GAC2500 FTP Server Settings

User Helper

For the first time, it powers up or after factory reset, GAC will open User helper and tips. Users can follow the guide to use GAC2500.

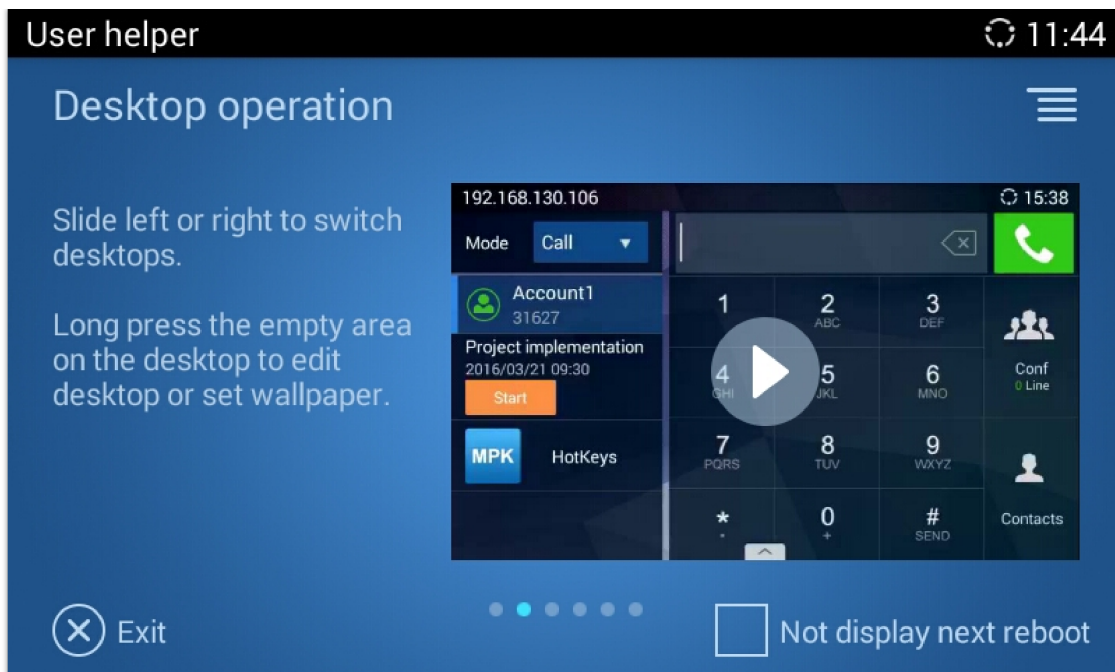



GAC2500 Quick User Guide

Downloads

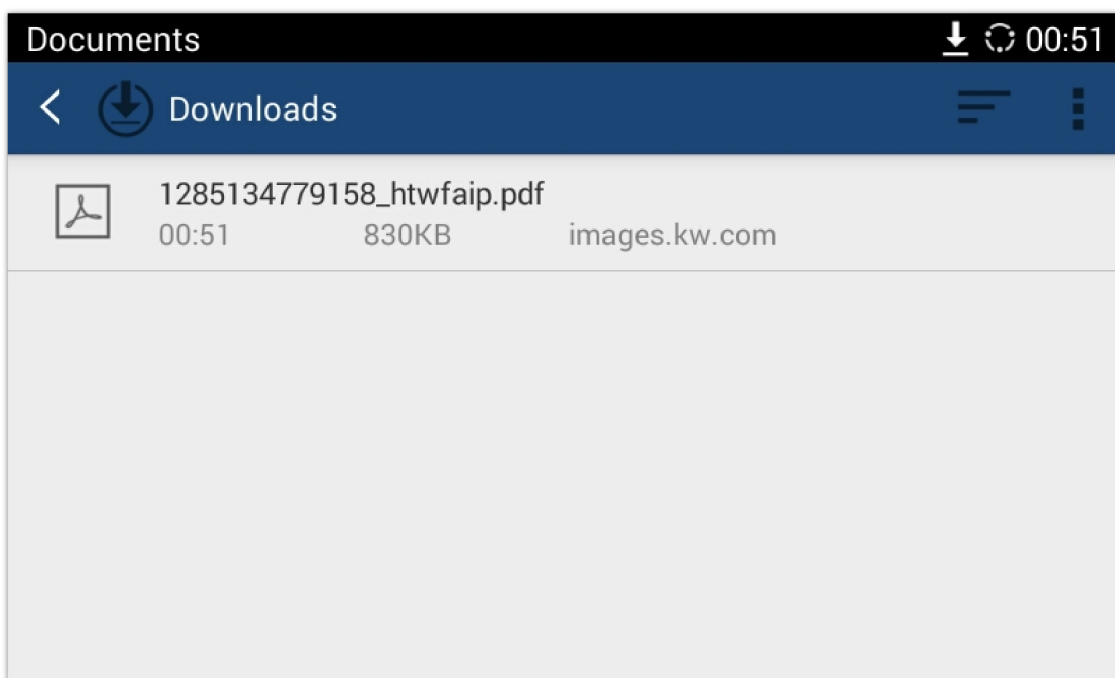
Downloads is for viewing and managing the files downloaded from internet. Click on the icon  to open Downloads.



Downloads

- Click on icon  to sort the files by name, date modified, or size.
- Click on icon  to configure the view of files.

GAC2500 WEB UI FEATURES

Accessing GAC2500 Web GUI

The IP address of the GAC2500 displays on LCD display screen.

To access the GAC2500 Web GUI:

1. Connect the computer to the same network as GAC2500.
2. Open a Web browser on your computer, enter the phone's IP address in the address bar of the browser; for example: <http://192.168.124.111>;
3. Enter the administrator's login and password to access the Web Configuration Menu. The default username and password are: admin, admin; you can set language to English or Chinese in the drop-down menu of language;



GAC2500 Web GUI – Login

4. Click "Login" to access the configurations in web UI.

Saving Changes

When changing any settings on the web UI, always submit them by pressing the SAVE button Save on the bottom of the page, and then clicking the Apply button on the top of the page to apply the configuration changes. For those options with  next to it in the Web page, users must reboot the GAC2500 for the changes to take effect.

Definitions

This section describes the 6 options in the GAC2500 Web GUI. Please view Advanced, Maintenance and Status specifications in Administration Guide.

- **Call:** Users could start conference and control conference from Web GUI.
- **Contacts:** Contacts, Schedule, Call History.
- **Account:** Configure account info.
- **Advanced:** General Settings, Call Features, Tone Generator, MPK General Settings, MPK LCD Settings.
- **Maintenance:** Network Settings, Time & Language, Security Settings, Upgrade, Troubleshooting, Device Manager.
- **Status:** Account Status, Network Status, System Info.

You can log in as an administrator or a normal user. The following table shows the web pages accessible by normal user and administrator.

User Type	Username	Default Password	Accessible Web Pages
Normal User	user	123	<ul style="list-style-type: none"> ● Call ● Contacts ● Account: Call Settings ● Advanced: MPK General Settings, MPK LCD Settings

			<ul style="list-style-type: none"> • Maintenance: Network Settings, Time & Language, Security Settings, Device Manager • Status: Account Status, Network Status, System Info
Administrator	admin	admin	All pages.

GAC2500 Users Access Permissions

Toolbar

The web UI tool bar is on the upper right corner of the web UI page.

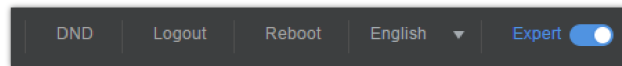

GAC2500 Web UI Tool Bar

- **DND:** Turn on/off DND mode. Once enabled, the DND text will turn into red and all incoming calls will be rejected.
- **English:** Select the display language for the web UI.
- **Reboot:** Reboot the device.
- **Expert:** Click to switch to expert mode and click again to cancel. Once enabled, the administrator can view all settings items.
- **Logout:** Log out from the web UI.

Call Page

GAC2500 Web UI call page is shown below. Users could make calls and initiate conference from Web UI.

The screenshot displays the 'Call' page of the GAC2500 Web UI. The top navigation bar includes 'Call', 'Contacts', 'Account', 'Advanced settings', 'Maintenance', and 'Status'. The left sidebar contains 'Account info' (with a red box around it) and 'Reservation status' (with a red box around it). The main content area shows a call log with columns for call status, numbers, and times. Annotations include: 'Multiple numbers can be separated with a comma ".".' above the input field; 'Input numbers, you can add up to 2 members.' in the input field; '0/6' next to the input field; 'Select call mode' pointing to the 'Call' dropdown; 'Click to dial out' pointing to the green call icon; 'Display call history and contacts' pointing to the call log; and 'Put cursor on one entry, click "+" to add this contacts to input bar' pointing to the '+' icon on the 'Jack, Sam, Gina' entry.

GAC2500 Web UI – Call

Making a Call

1. Select account in Account Info box;
2. Select call mode, then input phone number (s) in input box, use "," to separate different numbers or tap on other place on screen to confirm your input;
3. Tap on  to dial out.

You can also tap on  behind one call history entry to add the contact to input box.

Single Incoming Call

When the GAC is in idle, the dial screen will pop up when dialing out as shown below:

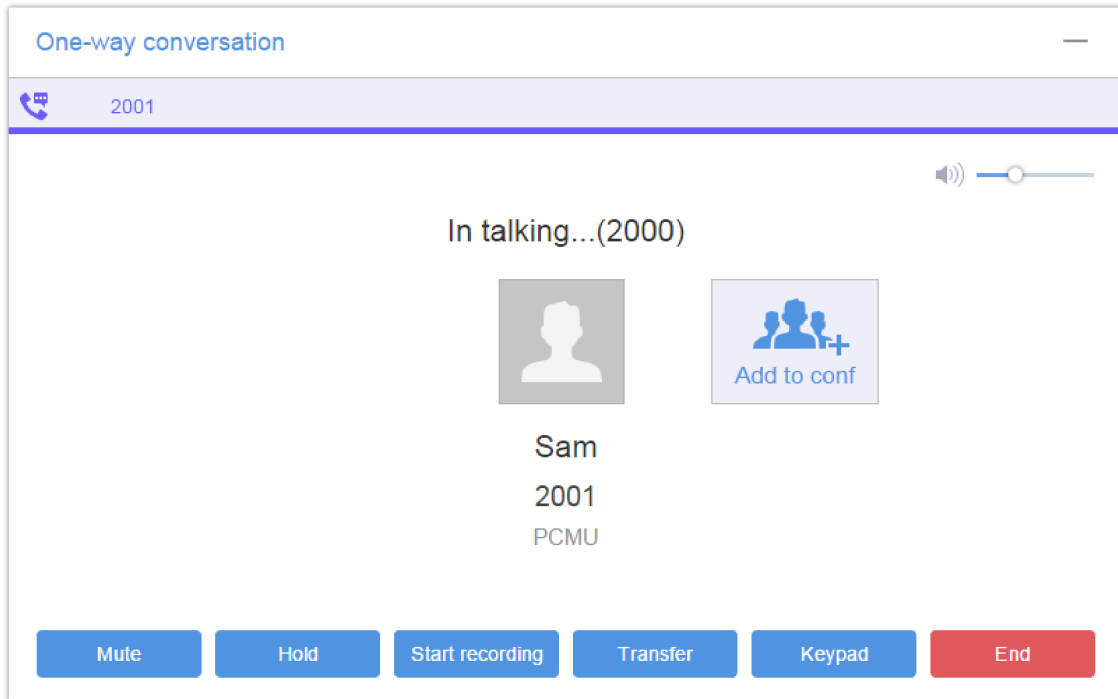

GAC2500 Web UI – Single Incoming Call

If the callee answers the call, you will see dial screen which is the same as the one on GAC2500 LCD.

Tap on  on the upper right corner to minimize dial screen to the lower right corner as shown below:

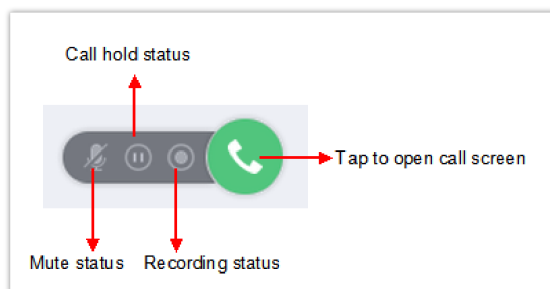

GAC2500 Web UI – Minimize Call Screen

When the line is in mute/hold/recording status, the corresponding icons will be highlighted.

Conference Control

When the GAC2500 is on conference, the conference screen is as shown below.

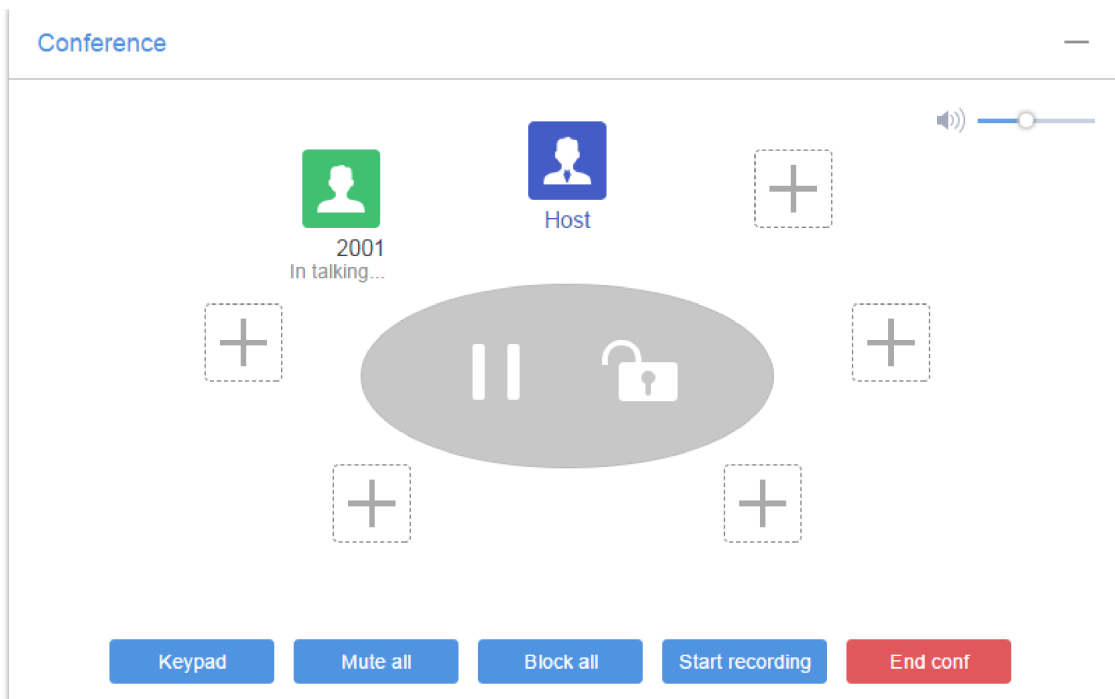

GAC2500 Web UI – Conference Control

The conference screen on Web is the same as the one on GAC2500 LCD.

Tap on  the upper right corner to minimize conference screen to the lower right corner as shown below:

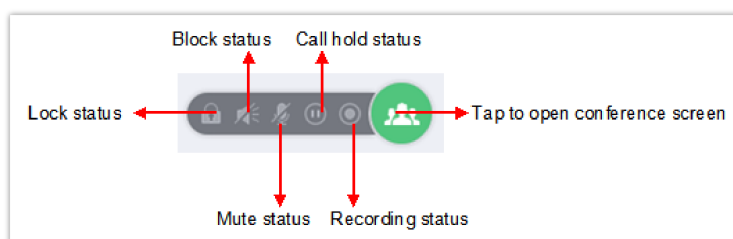

GAC2500 Web UI – Minimize Conference Screen

When the line is in lock/mute all/block all/hold/recording status, the corresponding icons will be highlighted.

Contacts Page

This page lists Contacts, Schedule, Call History and LADP.

Contacts

The operations will be synchronized and can be viewed from LCD as well. Users could search/add/delete/edit contact on web page. The web UI contacts page is as shown below.

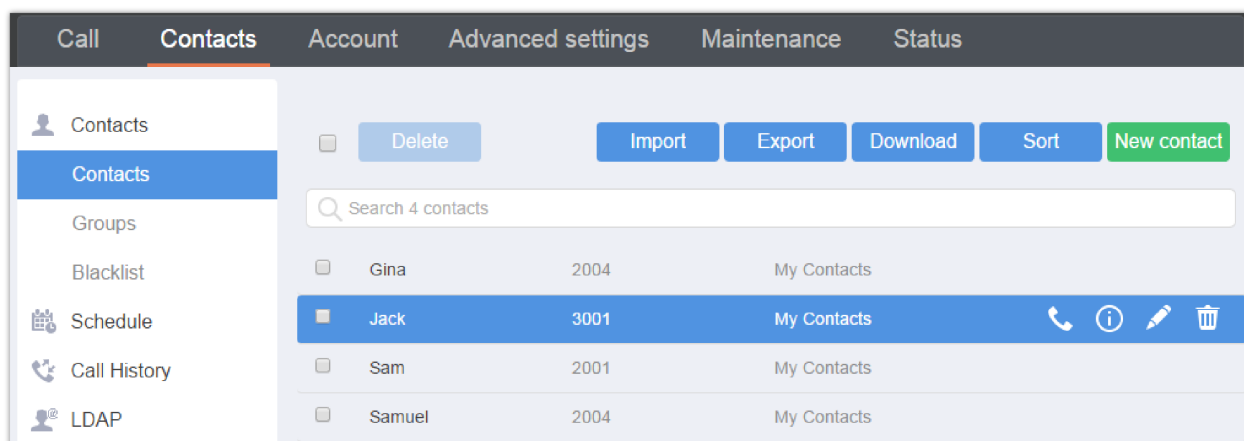



GAC2500 Web UI – Contacts

- Tap on "Import" option to access Import screen. Refer to chapter [BATCH IMPORT CONTACTS](#) to fill in info and import the contacts on PC to device.
- Tap on "Export" option to access Export screen. Refer to chapter [EXPORT CONTACTS](#) to fill in info and export the contacts on device to PC.
- Tap on "Download" option to access Download screen. Refer to chapter [DOWNLOAD CONTACTS](#) to fill in info and download the contacts on server to PC.
- Tap on "Sort" option to access Sort Phonebook screen. Sort the contacts by first name or last name.
- Tap on "New Contact" option to access Add Contact screen. Fill in contact information and save.

Put the cursor on contact to display more operation buttons.

 Tap to dial this contact.

 Tap to view the contact details.

 Tap to access Edit screen, you can edit contact and save the changes.

 Tap to delete this contact.

Groups

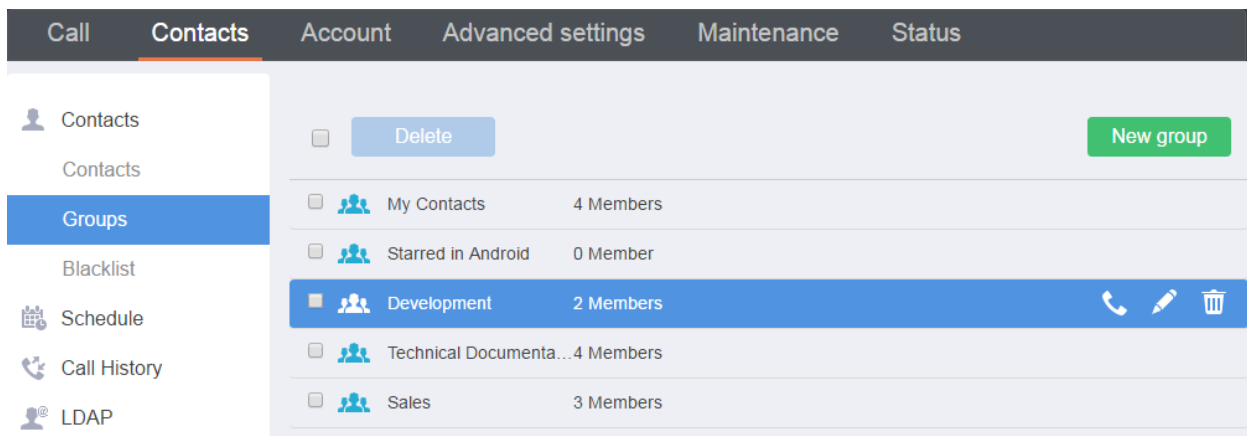



GAC2500 Web UI – Groups

- Tap on "New Contact" option to access New Group screen. Input group name and check group member (s) then save.
- Click on the group name to view all members in this group.

Put the cursor on group to display more operation buttons.

 Tap to call this group. Please note that GAC2500 supports up to 6 lines (7-way) conference. If there are more than 6 conference members, check 6 members you want to add to conference first.

 Tap to access Edit screen, you can edit group and save the changes.

 Tap to delete this group, the contacts in this group will not be deleted the same time.

Blacklist

Blacklist function on Web UI is the same as on local. Please refer to chapter [Blacklist](#) for more details.

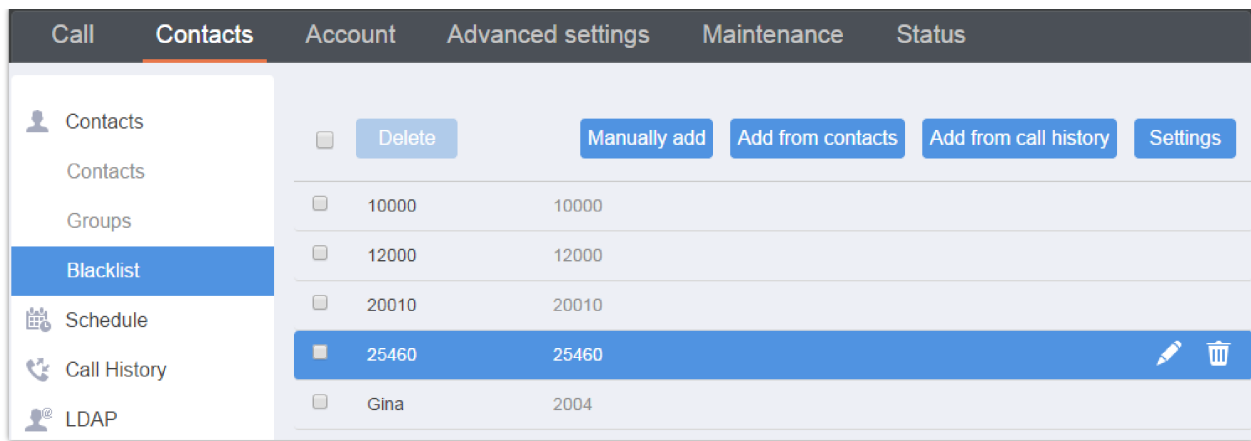

GAC2500 Web Page – Blacklist

Schedule

You can refer to chapter [Schedule](#) for more details.

◦ Upcoming Conference



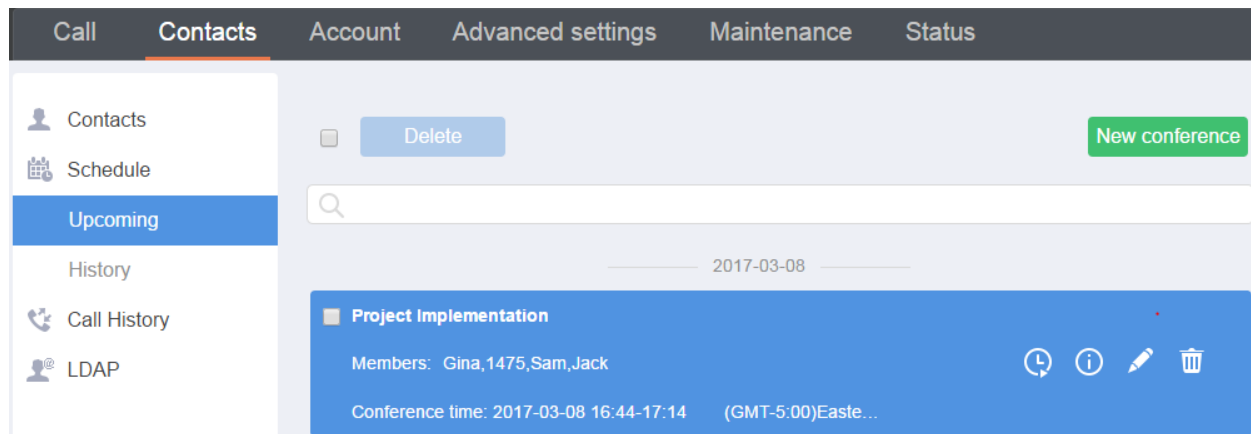

Conference can be scheduled, edited and deleted from web UI.



GAC2500 Web Page – Upcoming Conference

Tap on "New Conference" option to access New Conference screen. Input conference name and check conference member (s) then save.

Put the cursor on conference to display more operation buttons.

-  Tap to call this conference.
-  Tap to access Details screen. You can also edit and save conference on this screen.
-  Tap to access Edit Schedule screen, you can edit conference and save the changes.
-  Tap to delete this conference.

◦ History Conference

History conference screen is as shown below, you can dial/reschedule/delete history conference from web UI.

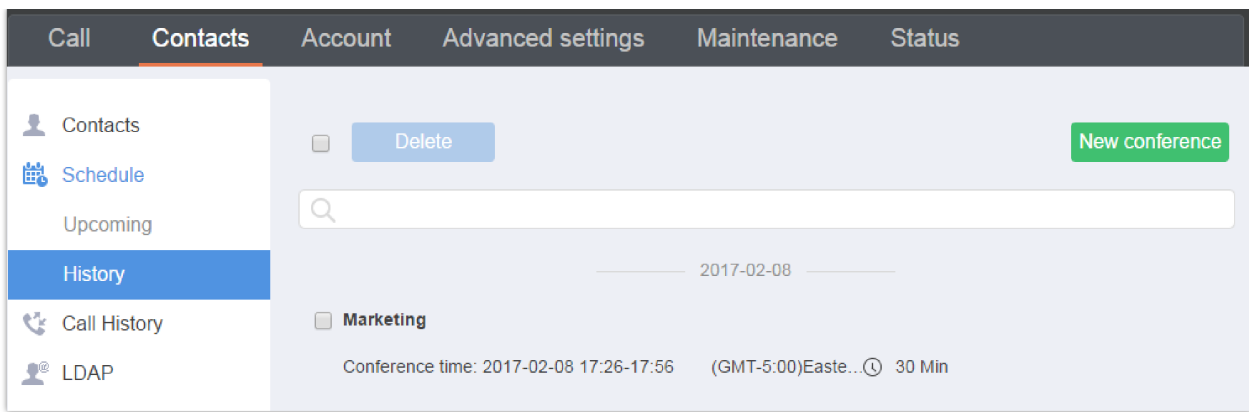

GAC2500 Web Page – History Conference

Put the cursor on conference to display more operation buttons.

Tap to call this conference.

Tap to access Details screen. You can also edit and save conference on this screen.

Tap to access Edit Schedule screen. You can reschedule the history conference on this screen.

Tap to delete this conference.

Call History

From web UI, users could also access Call history, which is synchronized with the call history from LCD.

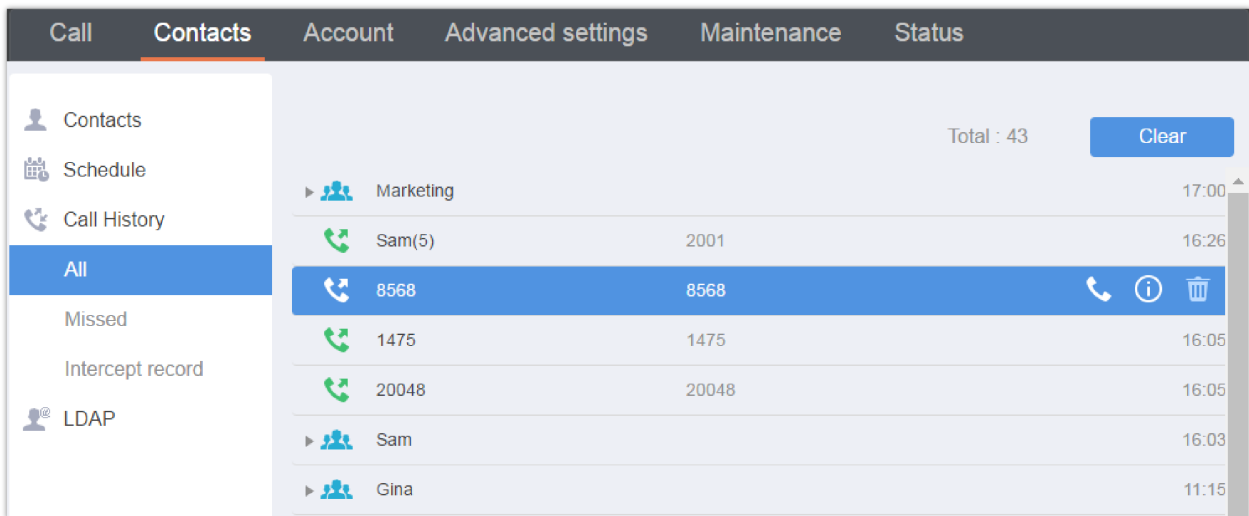

GAC2500 Web UI – Call History

○ Tap on “Clear” option to clear all call history.

Put the cursor on call history to display more operation buttons.

Tap to call this contact.

Tap to access Edit Schedule screen. You can reschedule the history conference on this screen.

Tap to delete this conference.

LDAP

From web UI, users can configure LDAP contacts. Please refer to chapter of **LDAP** under Application to fill in info and import LDAP contacts.

FACTORY RESET

Warning

Restoring the Factory Default Settings will delete all configuration information on the phone. Please backup or print all the settings before you restore to the factory default settings. Grandstream is not responsible for restoring lost parameters and cannot connect your device to your VoIP service provider.

Users could reset factory settings via the following ways: Reset via local GUI, via Web page, via the reset button on the back panel of GAC2500. Factory reset will delete configuration info and syslog info, the HDD data and videos will not be deleted.

Restore to Factory Default via LCD Menu

Access to the GAC2500 LCD **Settings**→**Advanced Settings**→**Factory Reset**, tap on Factory Reset, a confirmation message will be displayed. Tap on **OK** to confirm or return to avoid.

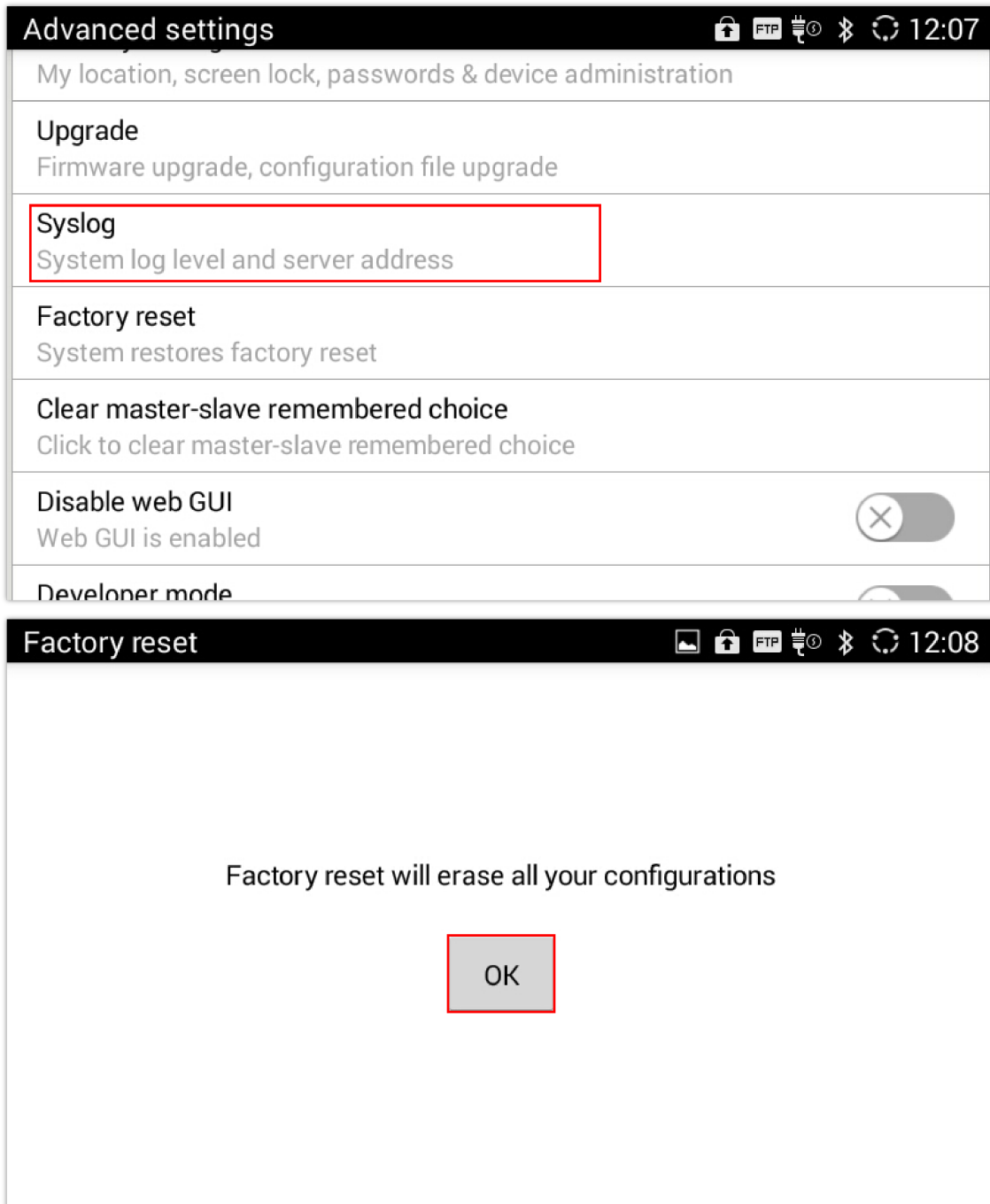

Factory reset

Restore to Factory Default via the Web GUI

1. Access to the GAC2500 Web GUI → **Maintenance**→**Upgrade** page.
2. At the bottom of the page, click on the **Reset** button for Factory reset. Select whether you would like to clear the SD card if there is SD card plugged in.

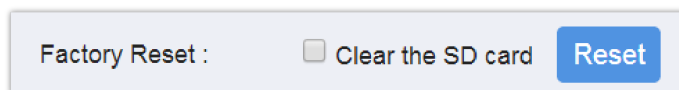

Factory Reset on Web UI

3. A dialog box will pop up to confirm factory reset;

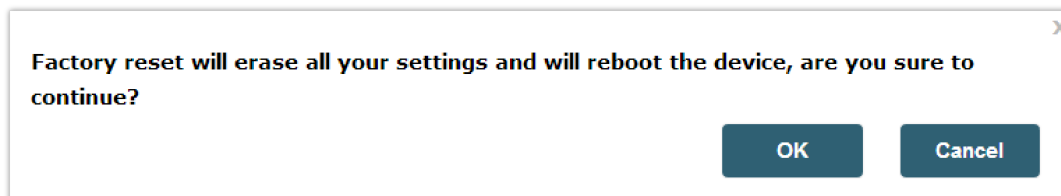

Web UI – Factory Reset Confirmation

4. Click **OK** to restore the phone to factory settings.

Reset Via Button

Use a small pin to press the button Reset button on the back panel of GAC2500 for more than 10 seconds to reboot and restore to factory reset.

EXPERIENCING THE GAC2500 APPLICATION PHONE

Please visit our website: <http://www.grandstream.com> to receive the most up- to-date updates on firmware releases, additional features, FAQs, documentation and news on new products.

We encourage you to browse our [product related documentation](#), [FAQs](#) and [User and Developer Forum](#) for answers to your general questions. If you have purchased our products through a Grandstream Certified Partner or Reseller, please contact them directly for immediate support.

Our technical support staff is trained and ready to answer all of your questions. Contact a technical support member or [submit a trouble ticket online](#) to receive in-depth support.

Thank you again for purchasing Grandstream Enterprise Application phone, it will be sure to bring convenience and color to both your business and personal life.

* **Android is a trademark of Google Inc.**

* **Skype and Lync are Registered Trademarks of Microsoft Corporation.**

CHANGE LOG

This section documents significant changes from previous versions of GAC2500 user manuals. Only major new features or major document updates are listed here. Minor updates for corrections or editing are not documented here.

Firmware Version 1.0.3.48

- No Major changes.

Firmware Version 1.0.3.47

- No Major changes.

Firmware Version 1.0.3.45

- No major changes.

Firmware Version 1.0.3.42

- No major changes

Firmware Version 1.0.3.38

- No major changes

Firmware Version 1.0.3.37

- No major changes

Firmware Version 1.0.3.35

- Supported BroadWorks Xtended Services Interfaces (XSI) features. [[Broadworks XSI Contacts](#)]

Firmware Version 1.0.3.30

- No major changes

Firmware Version 1.0.3.27

- No major changes

Firmware Version 1.0.3.20

- Optimize Bluetooth performance.
- Added support for TLSv1.1 and TLSv1.2.
- Added option to block image gallery options via GUI Config Tool 3.9.0. [[block image gallery options](#)]

Firmware Version 1.0.3.17

- Updated some Chinese translation in LCD menu.

Firmware Version 1.0.3.13

- Updated displaying caller information based on "Referred-By" header in incoming call page on LCD. [[Incoming Transferred call notification](#)]

Firmware Version 1.0.3.11

- Deleted "Lock" in Add conference. [[Conference](#)]
- Added volume control bar in conference on web UI. [[Volume control](#)]
- Made members label visible when adding new members in Schedule. [[Schedule](#)]
- Added total number of calls in Call History in web UI. [[Call History](#)]
- Added a prompt to recover intercepted calls from blacklist. [[Blacklist](#)]
- Hid "Associated account" in Schedule if there is no active account. [[Active account](#)]
- Added support to change background color when clicking a file in File Manager List view. [[File Manager](#)]
- Updated prompt of exporting record file on LCD. [[Call record](#)]
- Updated prompt of video call request on LCD. [[Video Call](#)]

Firmware Version 1.0.3.5

- Prompt tips when GAC2500 is connected to wrong GVC USB port. [[USB Slave Mode](#)]
- Improved audio process performance.
- Supports using dial pad to dial out call in Skype for business app. [[Account](#)]

- When removing app from GUI Config tool, the GAC2500 will delete it including background service rather than hiding the app in background only.
- Added call detail in calling interface. When in a call, simply choose “More” and “Call Details”. [[Call Details](#)]
- DUT in a conference with an outgoing call will add all incoming call to conference. [[Answering an Incoming Call in Conference](#)]
- Changed LDAP search timeout unit to second. [[Search timeout \(s\)](#)]
- Changed internal storage icon. [[File Manager](#)]
- Modify phone type and Email type to English only while importing/exporting Contacts xml file on Universal Phone Editor.
- Added more operation on LCD for GVC320x when GAC2500 is connected to GVC320x via USB. [[USB Slave Mode](#)]
- Added count of calls for call history on LCD. [[Call Count Call History](#)]
- Improved DUT’s behavior when using option “Use # as Dial Key” to dial out. [[Direct Dialing](#)]
- Added support for Google Calendar conference schedule features. [[Schedule Conference via Google Calendar](#)]
- Shortened reminding tone for incoming intercom call. [[Paging/Intercom](#)]
- Added support for Bluetooth A2DP sink role, which means GAC2500 can connect to GVC320x and mobile devices via Bluetooth to play music files. [[Play music files.](#)]
- Packed new CFG file for new hardware production.
- Added some missing tooltips.
- Improved the web UI design on IE browser.
- Added voice mode setting, users can set 6 different voice modes. [[Sound](#)]
- Trimmed the multicast name displaying on web talking interface.
- Allowed DUT to display a widget shape even there is no account registered.

Firmware Version 1.0.1.45

- No major changes.

Firmware Version 1.0.1.44

- No major changes

Firmware Version 1.0.1.40

- Improved the sound quality.
- The 3.5mm interface is mainly used for placing a cellphone in a conference. So, the volume range differs from cellphones. Please adjust the volume on the cellphone if it is too high. [[Call Management](#)]

Firmware Version 1.0.1.34

- The dial pad has a MPK access key, and MPK app has different layout. [[Shortcut](#)]
- MPK app is renamed to Hotkeys. [[Hotkeys](#)]
- Updated call feature of Contact on dial pad. [[Dialing a number via contact](#)]
- Updated LCD layout (Only reset to enable new layout. Move some apps to Tool Folder). [[Toolbar](#)]
- Enabled password for schedule conference. [[Initiate a Conference](#)]
- Added ability to start a contact and put it on top of contact. [[Contacts](#)]
- Added direct IP call on dial pad without changing call mode. [[Direct IP Call](#)]
- Added ability to create a hotkey for a contact or a group. [[hotkeys](#)]
- Updated RJ48 cascade mode. LCD supports complete synchronization. [[Cascade Mode](#)]
- When screen lock is enabled, unlock is required for MPK, transfer, add to Conf in a call. [[Lock](#)]
- Added a PNP icon on status bar when enabled. [[Status icons](#)]
- Updated videos in Tips app. [[User helper](#)]

Firmware Version 1.0.1.26

- Added setting LCD home screen. [[Home Screen](#)]
- Added Hold/UnHold for individual conference participant. [[Hold/UnHold](#)]
- Added FTP server. [[FTP Server](#)]
- Added GAC2500 quick guide. [[GAC2500 quick guide](#)]

Firmware Version 1.0.1.18

- Increased call history to 2000 entries. [[Telephony Features](#)]
- Updated 3.5mm AUX line sequence interface. [[Auxiliary Ports](#)]
- Added cycle conference. [[Add Scheduled Conference](#)]
- Updated the chapter of third party application. [[Sample Applications](#)]

Firmware Version 1.0.1.16

- This is the initial version.