

Grandstream Networks, Inc.

GDS370x - User Manual



WELCOME

Thank you for purchasing Grandstream GDS370x Audio Door Access System,



The GDS3705 was built for users looking for a strong audio-only facility access and security monitoring solution that can be deployed in environments of all sizes. This audio door system features dual microphones and HD loudspeaker with advanced AEC to offer intercom functionality, can support SIP calls to IP phones and has a built-in RFID chip reader and keypad for secured keyless or key entry. The GDS3705 comes equipped with a zinc alloy metal casing, making it weatherproof and vandal resistant and offers alarm-in and alarm-out support for integration with existing security devices. The GDS3705 integrates with Grandstream’s free management utility software, GDS Manager, allowing RFID card information, as well as the device itself to be fully managed by this software. Thanks to its integration with other Grandstream endpoints like the GXP IP phones, GXV video phones, portable WiFi and DECT IP phones and Grandstream Wave mobile app, the GDS3705 offers a complete end-to-end solution for access control, audio intercom, and security needs

The GDS3702 is an HD Audio IP Intercom System to offer remote facility access control for buildings of all sizes. This device includes a built-in microphone and speaker to support intercom functionality, supports integration with electric locks for locking and unlocking doors, and offers alarm-in and alarm-out support for integration with existing security systems. The GDS3702 works with Grandstream’s free management software, GDS Manager. It features SIP/VoIP technology with 2-way HD audio, IP66 level weatherproof casing, and is vandal resistant. The combination of the GDS3702, Grandstream’s IP Phones, Wave mobile app, and other 3rd party IP devices provide a complete end-to-end solution for access control, and intercom needs.

PRODUCT OVERVIEW

Feature Highlights

The following table contains the major features of the GDS370x.

	<ul style="list-style-type: none"> ● 4 SIP accounts and 4 lines. ● Broad interoperability with most 3rd party SIP/VoIP devices and leading SIP/NGN/IMS platforms ● 2 Channels Input/Output alarm. ● RS485, Wiegand (26 bits) Input and Output. ● RFID card reader. ● Weatherproof, vandal resistant. ● Built-in microphone and speaker offers voice options and intercom functionality
	<ul style="list-style-type: none"> ● 4 SIP accounts and 4 lines. ● Broad interoperability with most 3rd party SIP/VoIP devices and leading SIP/NGN/IMS platforms ● 2 Relay for Electric Lock and Alarm out, 2 Alarm In for Exit button and door sensor ● Weatherproof, vandal resistant. ● Built-in microphone and speaker offers voice options and intercom functionality

Technical Specifications

The following table resumes all the technical specifications including the protocols/standards supported, voice codecs, telephony features, and upgrade/provisioning settings for GDS370x.

GDS3705

Network Protocols	TCP/IP/UDP, RTP/RTCP/RTCP-XR, HTTP/HTTPS local upload and mass provisioning using TR-069, ARP/RARP, ICMP, DNS, DHCP, SSH, SMTP, NTP, STUN, TLS, SRTP.
SIP/VoIP Support	Broad interoperability with most 3 rd party SIP/VoIP devices and leading SIP/NGN/IMS platforms.
Voice Codecs	G.711μ/a-law, G.722, G.729A/B, DTMF (RFC2833, SIP INFO), AEC.
QoS	Layer 2 QoS (802.1Q, 802.1P).
Security	Administrator level access control (pending), MD5 and MD5-sess-based authentication, 256-bit AES encrypted configuration file, TLS, SRTP, HTTPS, 802.1Q.
Upgrade / Provisioning	Firmware upgrade via HTTP/HTTPS, mass provisioning using TR-069 or AES encrypted XML configuration file.
Audio Input	Integrated dual microphones.
Audio Output	Built-in HD Loudspeaker (2 Watt), sound quality suitable for up to 3 m.
Keypad / Buttons	12-Metal Keys plus a Metal doorbell button.
RFID	125KHz: EM4100 (1 RFID card and 1 RFID key fob included).
Alarm Input	Yes, 2 channels, Vin < 15V, for door sensors or other devices.
Alarm Output	Yes, 2 channels, 125VAC/0.5A, 30VDC/2A, Normal Open or Normal Close, for electric lock, light switch or other devices.
Network Interface	10M/100M auto-sensing.
Expansion Interface	RS485, Wiegand (26 bits) input and output.
Dimensions and Weight	On-Wall : 173mm(H) x 80mm(W) x 36mm(D). In-Wall : 217mm x 120mm x 11.6mm 0.635 Kg.
Power Supply	PoE (Power over Ethernet) IEEE 802.3af Class 3, or 12VDC/1A connection (AC power adapter not included).
Ingress Protection	Weatherproof, vandal-resistant, with support for extra back reinforcing metal plate

Temperature and Humidity	<p>Operation: -30°C to 60°C (-22°F to 140°F)</p> <p>Storage: -35°C to 60°C (-31°F to 140°F)</p> <p>Humidity: 10% to 90% Non-condensing</p>
Protection Class	IP66 (EN60529), IK09 (IEC62262).
Compliance	<p>FCC: Part 15; Subpart B; Subpart C; MPE</p> <p>CE: EN 55032; EN 50130; EN 61000-3-2; EN 61000-3-3; EN 60950-1; EN 300 330; EN 301 489-1; EN 301 489-3; EN 62311</p> <p>RCM: AS/NZS CISPR 22/24; AS/NZS 4268; AS/NZS 60950.1</p> <p>IC: ICES-003; RSS310</p>

GDS3705 Technical Specifications

GDS3702

Network Protocols	TCP/IP/UDP, RTP/RTCP/RTCP-XR, HTTP/HTTPS local upload and mass provisioning using TR-069, ARP/RARP, ICMP, DNS, DHCP, SSH, SMTP, NTP, STUN, TLS, SRTP.
SIP/VoIP Support	Broad interoperability with most 3 rd party SIP/VoIP devices and leading SIP/NGN/IMS platforms.
Voice Codecs	G.711μ/a, G.722, DTMF(RFC2833, SIP INFO), AEC, ANC
QoS	Layer 2 QoS (802.1Q, 802.1P).
Security	Administrator level access control (pending), MD5 and MD5-sess-based authentication, 256-bit AES encrypted configuration file, TLS, SRTP, HTTPS, 802.1Q.
Upgrade / Provisioning	Firmware upgrade via HTTP/HTTPS, mass provisioning using TR-069 or AES encrypted XML configuration file.
Audio Input	Built-in microphones up to 1.5m
Audio Output	Built-in HD Loudspeaker (2 Watt), sound quality suitable for up to 3 m.
Alarm Input	Yes, 2 channels, Vin < 15V, for door sensors or other devices.
Alarm Output	Yes, 2 channels, 125VAC/0.5A, 30VDC/2A, Normal Open or Normal Close, for electric lock, light switch or other devices.
Network Interface	10M/100M auto-sensing.
Expansion Interface	RS485, Wiegand (26 bits) input and output.

Dimensions and Weight	<p>On-Wall : 173mm(H) x 80mm(W) x 36mm(D).</p> <p>In-Wall : 217mm(H) x 120mm(W) x 11.6mm(D).</p> <p>0.672 Kg.</p>
Power Supply	PoE (Power over Ethernet) IEEE 802.3af Class 3, or 12VDC/1A connection (AC power adapter not included).
Ingress Protection	Weatherproof, vandal-resistant, with support for extra back reinforcing metal plate
Temperature and Humidity	<p>Operation: -30°C to 60°C (-22°F to 140°F)</p> <p>Storage: -35°C to 60°C (-31°F to 140°F)</p> <p>Humidity: 10% to 90% Non-condensing</p>
Protection Class	IP66 (EN60529), IK09 (IEC62262).
Compliance	<p>FCC: Part 15; Subpart B; Subpart C; MPE</p> <p>CE: EN 55032; EN 50130; EN 61000-3-2; EN 61000-3-3; EN 60950-1; EN 300 330; EN 301 489-1; EN 301 489-3; EN 62311</p> <p>RCM: AS/NZS CISPR 22/24; AS/NZS 4268; AS/NZS 60950.1</p> <p>IC: ICES-003; RSS310</p> <p>UKCA</p>

GDS3702 Technical Specifications

GETTING STARTED

This chapter provides basic installation instructions including the list of the packaging contents and information for obtaining the best performance using the GDS370x Audio Access Door System.

Equipment Packaging

GDS3705

<ul style="list-style-type: none"> ● 1 x GDS3705. ● 1 x Installation Bracket. ● 1 x Drilling Template. ● 4 x Rubber Gaskets (for sealing the back cable). ● 6 x Back Panel Screws. ● 6 x Bracket Screws and Anchors. ● 4 x Anti-tamper screws. ● 1 x Anti-Tamper Hex Key. 	<ul style="list-style-type: none"> ● 1 x Wiegand Cable. ● 1 x RFID Card (more can be purchased from Partner/reseller). ● 1 x Key Fob (more can be purchased from Partner/reseller). ● 1 x Frame Back Cover. ● 1 x Quick Installation Guide. ● 1 x GPL License.
---	--



GDS3705 Package

GDS3702

- | | |
|--|---|
| <ul style="list-style-type: none"> • 1 x GDS3702. • 1 x Installation Bracket. • 1 x Drilling Template. • 4 x Rubber Gaskets (for sealing the back cable). • 6 x Back Panel Screws. • 6 x Bracket Screws and Anchors. | <ul style="list-style-type: none"> • 1 x Wiegand Cable. • 1 x Anti-Tamper Hex Key. • 4 x Anti-tamper screws. • 1 x Frame Back Cover. • 1 x Quick Installation Guide. |
|--|---|

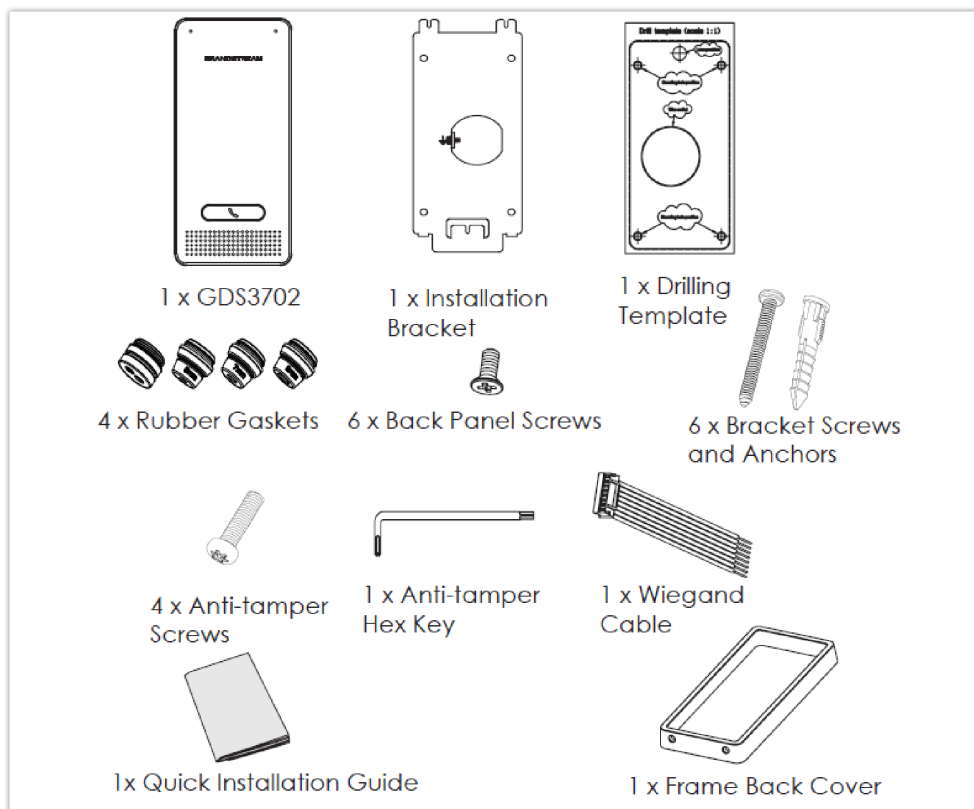

GDS3702 Package

Note

Check the package before installation. If you find anything missing, contact your system administrator.

Description of the GDS370x

The below figures show the component of the back and front view of the GDS370x IP Audio Access Door System:

GDS3705

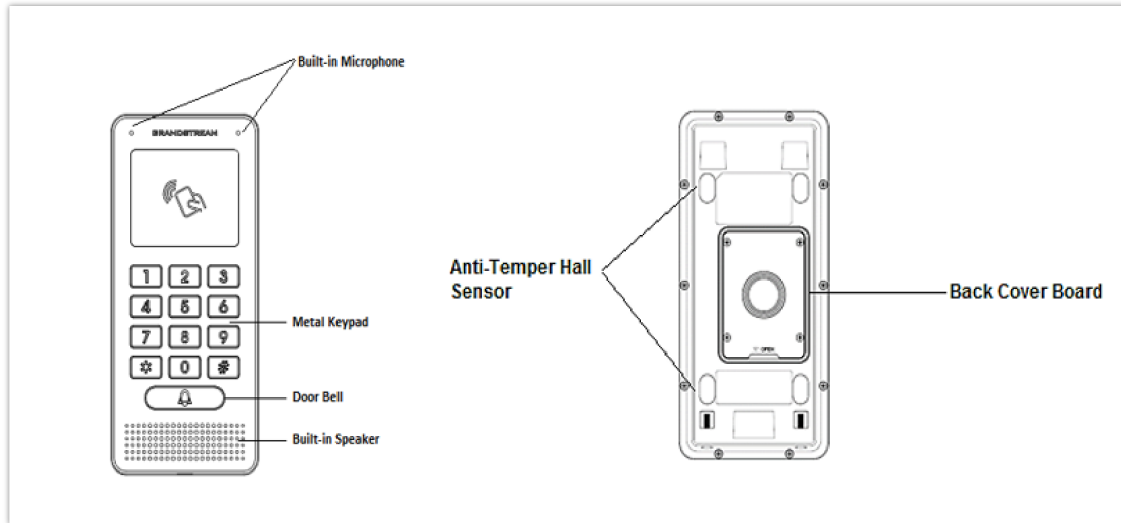

GDS3705 Front&Back View

GDS3702

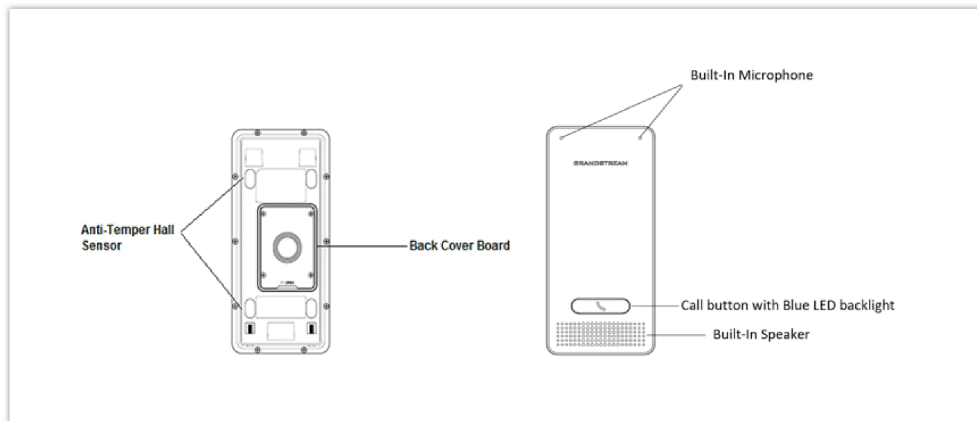

GDS3702 Front&Back View

Connecting and Setting up the GDS370x

The GDS370x can be powered using PoE or PSU:

Using PoE as a power supply (Suggested)

- Connect the other end of the RJ45 cable to the PoE switch.
- A PoE injector can be used if the PoE switch is not available.

Using the power adapter as a power supply (PSU not provided)

- Connect the other end of the RJ45 cable to the network switch or router.
- Connect the DC 12V power source via the related cable to the corrected PIN of the GDS370x.

GDS370x Wiring Connection

Jack	Signal	Function	Note	
J2 (Basic) 3.81mm	TX+	Ethernet PoE 802.3af Class 3, 12.95W	Orange / White	Data
	TX-		Orange	
	RX+		Green / White	
	RX-		Green	
	PoE_SP2		Blue + Blue/White	Please twist these two wires together and connect to SP1, SP2 respectively even the PoE NOT used.
	PoE_SP1	Brown + Brown/White		
	RS485_B	RS485		
	RS485_A			
	GND	Power Supply	DC 12V, 1A Minimum	
	12V			
J3 (Advanced) 3.81mm	GND	Alarm GND		
	ALARM1_IN+	Alarm In	Vin<15V	
	ALARM1_IN-			
	ALARM2_IN+			
	ALARM2_IN-			
	NO1	Alarm Out	Relay: 30VDC/2A; 125VAC/0.5A	
	COM1			
	NO2	Electric Lock	For " Fail Secure " (Locked when Power Lost) Strike, connect COM2 & NO2 . For " Fail Safe " (Open when No Power) Magnetic Lock, connect COM2 & NC2 . Relay: 30VDC/2A; 125VAC/0.5A	
	COM2			
	NC2			
J4 (Special) 2.0mm	GND	Wiegand Power GND	Black	Both Input and Output MUST be connected
	WG_D1_OUT	Wiegand Output Signal	Orange	GDS3705 function as Output of Card Reader, Connect Pin 1, 2, 3
	WG_D0_OUT		Brown	
	LED	Wiegand Output	Blue	For External Card Reader; Or

	LED Signal		GDS3705 as Receiver Only
WG_D1_IN	Wiegand Input Signal	White	For External Card Reader Connect Pin 1,4,5,6,7,8
WG_D0_IN		Green	
BEEP	Wiegand Output BEEP Signal	Yellow	For External Reader Only
5V	Wiegand Power Output	Red	For External Card Reader Only. 12VDC powered External Card Reader must use own power source, can NOT use this Pin.

GDS3705 Wiring Connection

GDS370x Back Cover Connections

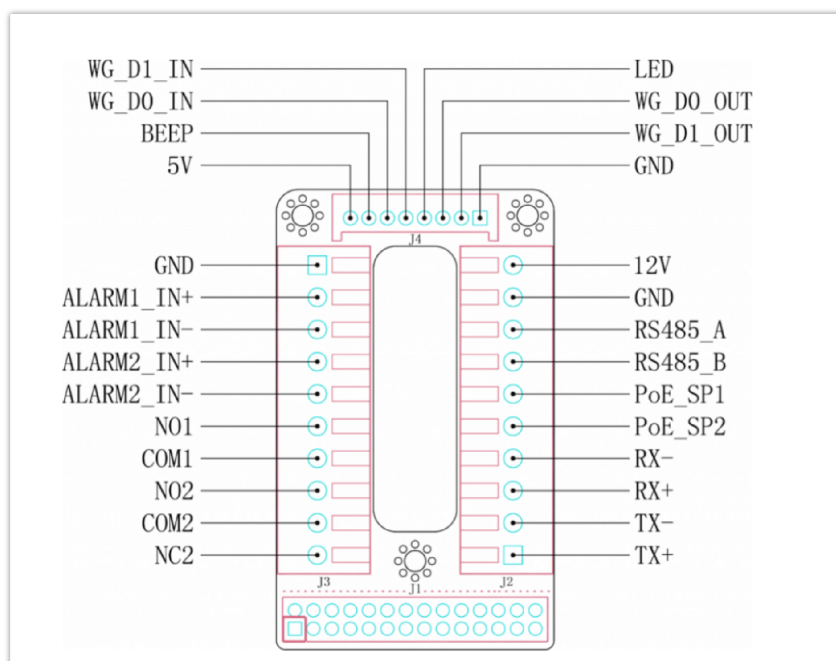

GDS370x Back Cover Connections

Connection Example

To connect the GDS either by using PoE or PSU follow the steps below:

- Open the Back-Cover Board of the GDS370x which should look like the following figure.

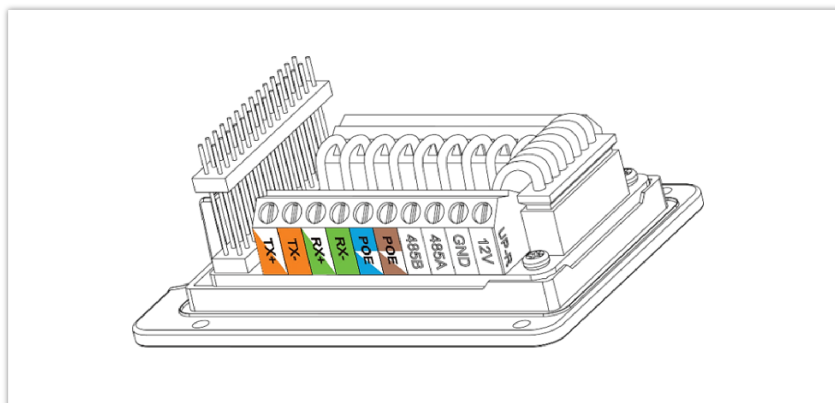

GDS370x Back Cover

Power GDS370x using PoE

- Cut into the plastic sheath of your Ethernet cable, then Unwind and pair as shown below.

Use the TIA/EIA 568-B standard, which defines pin-outs for using Unshielded Twisted Pair cable and RJ-45 connectors for Ethernet connectivity.

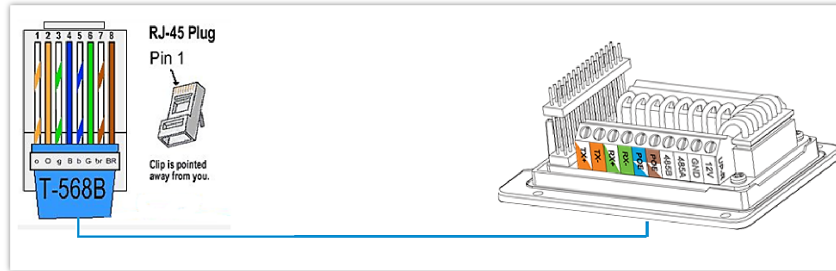

Connection Example

- Connect each wire of the cable to its associate on the Back Cover of the GDS370x to power the unit using PoE.

Power GDS370x using PSU

- To power the unit using PSU, use a multimeter to detect the polarity of your Power Supply, then connect GND to the negative pole and 12V to the positive pole of the PSU.

Note

If the user doesn't have PoE switch, there is no need to connect the Blue and Brown wires to the GDS370x since these wires are used to power the unit via Ethernet.

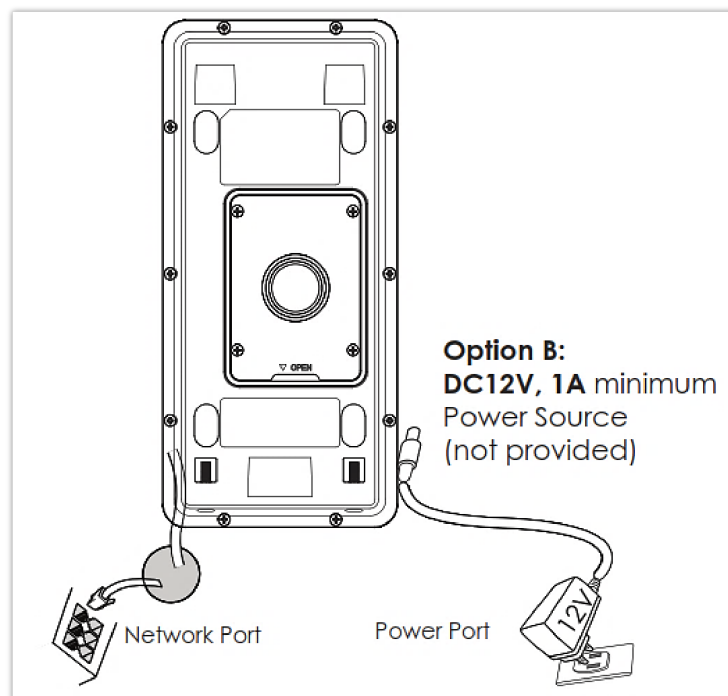

Powering the GDS370x

GETTING TO KNOW GDS370x

The GDS370x has an embedded Web server to respond to HTTP/HTTPS GET/POST requests. Embedded HTML pages allow users to configure the GDS370x through all available Web browsers in the internet.

Connecting GDS370x to Network with DHCP Server

The GDS370x by default has a DHCP client enabled, it will automatically get IP address from DHCP server.

Windows Platform

Two ways exist for Windows users to get access to the GDS370x:

UPnP

By default, the GDS370x has the UPnP feature turned ON. For customers using Windows network with UPnP turned on (most SOHO routers support UPnP), it is very easy to access the GDS370x:

1. Find the "Network" icon  on the Windows Desktop.
2. Click the icon to get into the "Network", the GDS370Xs will list as "Other Devices" shown like below. Refresh the pages if nothing is displayed. Otherwise, the UPnP may not be active in the network.

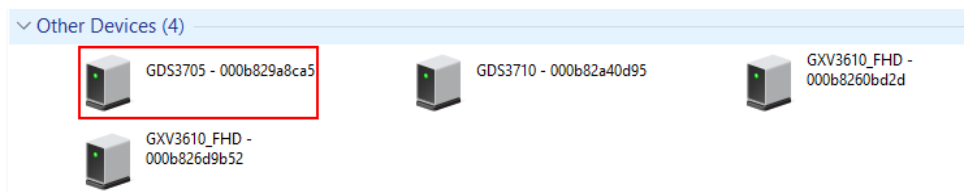
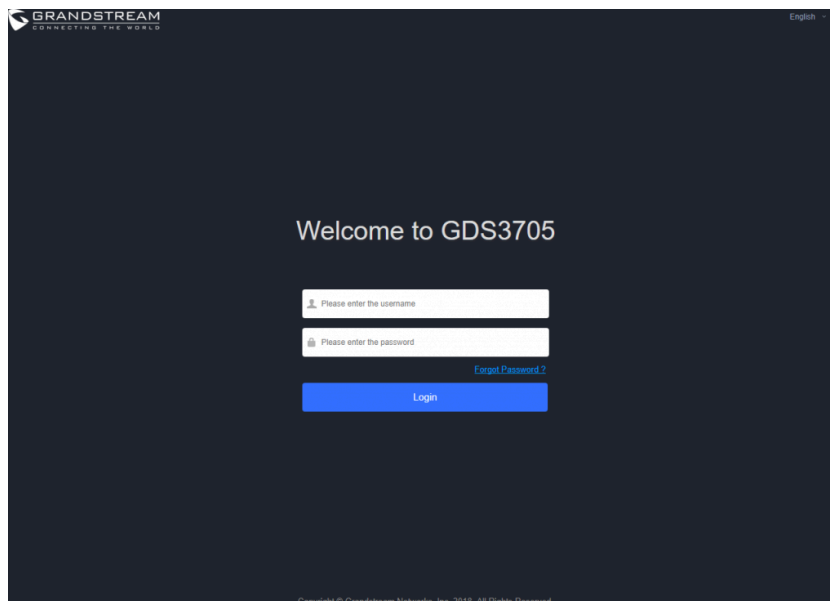

Figure 8: Detecting GDS370x via UPnP

3. Click on the displayed icon of related GDS370x, the default browser (e.g.: Internet Explorer, Firefox, or Chrome) will open and connect directly to the login webpage.



GDS3705 Login Page

GS Search

GS search is a program that is used to detect and capture the IP address of Grandstream devices. Below are instructions for using the "GS Search" utility tool:

- Download the GS Search utility tool from the Grandstream website using the following link: [GS_Search](#)
- Double click on the downloaded file and the search window will appear.
- Click on  button to start the discovery for Grandstream devices.
- The detected devices will appear in the output field like below.

Index	Model	Version	Device Name	IP	HTTP Port	RTSP Port	MAC
1	D00RDEV GDS3705	1.0.0.20	GDS3705	192.168.5.182	443	0	00:08:82:9A:8C:A5

Search Add

GS Search Discovery

- Double click on a device to access its web GUI.

GDS Manager Utility Tool

Users can know the IP address assigned to the GDS370x from the DHCP server log or using the Grandstream GDS Manager after installing this free utility tool provided by Grandstream. Users can find instructions below, for using the “GDS Manager” utility tool:

1. Download the GDS Manager utility tool from the Grandstream website using the following link: [GDSManager Download](#)
2. Install and run the Grandstream GDS Manager, a client/server architecture application, the server should be running first, then GDSManager (client) later:



3. On the GDS Manager access to **Device** → **Search** and Click on the Search button to start device detection

4. The detected devices will appear in the output field like below:

Index	Model	Version	Device Name	IP	Web Port	RTSP Port	Mac
<input checked="" type="checkbox"/> 1	GDS3710	1.0.3.13	GDS3710	192.168.5.13	443	554	00:08:82:A4:0D:95
<input type="checkbox"/> 2	GDS3705	1.0.0.20	GDS3705	192.168.5.182	443		00:08:82:9A:8C:A5

GDS370x Detection using GDS Manager

5. Double click the column of the detected GDS370x, and the browser will automatically open and show the device’s web configuration page.

6. Enter the administrator user name and password to access the Web Configuration Interface, the default admin username is “**admin**” and the default random password can be found at the sticker on the GDS3705.

Connect to the GDS370x using Static IP

If there is no DHCP server in the network, or the GDS370x does not get IP from the DHCP server, the user can connect the GDS370x to a computer directly, using static IP to configure the GDS370x.

1. The default IP, if no DHCP server, or DHCP request times out (after 3 minutes), is **192.168.1.168**
2. Connect the Ethernet cable from GDS370x to the computer network port directly.
3. Configure the computer using Static IP: 192.168.1.XXX (1<XXX<255, except for 168) and configure the "Subnet mask" to "255.255.255.0". Leave the "Default Gateway" to "Blank" like below:

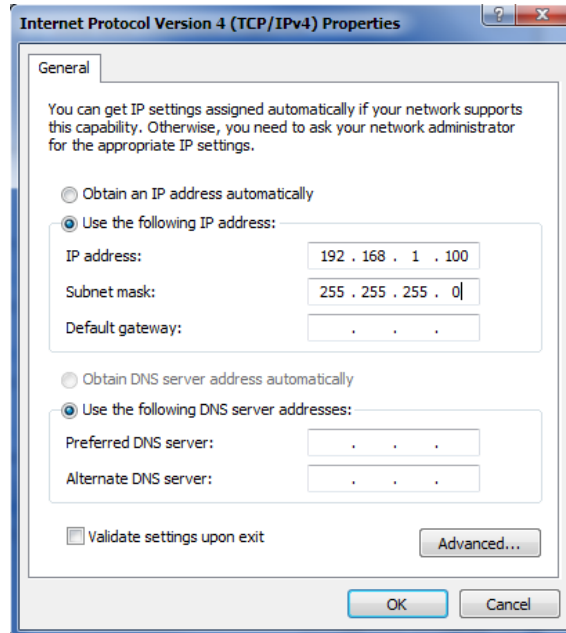

Static IP on Windows

4. Power on the GDS370x, using a PoE injector or external DC power.
5. Enter 192.168.1.168 in the address bar of the browser, and log in to the device with admin credentials. the default admin username is **"admin"** and the default random password can be found on the sticker on the GDS3705.

GDS370x APPLICATION SCENARIOS

The GDS370x Door System can be used in different scenarios. We will be using the GDS3705 Model as our testing unit.

Peering Mode without SIP Server

For environments like remote warehouse/storage, grocery store, small (take-out) restaurants, just using static IP with PoE switch to form a LAN, using Grandstream's audio phone GXP21XX/17XX/16XX series, the GDS370x will meet your very basic intercom and open-door requirements.

This is the solution to upgrade the traditional analog Intercom system. All you need is a Power source, Switch or PoE Switch, and Grandstream IP phones.

The equipment list can be found below:

- o GDS370x
- o Grandstream IP Phones
- o PoE Switch with related Cat5e/Cat6 wiring

Peering using SIP Server (UCM6XXX)

For large deployment, multiple GDS370x units might be required, peered connection will not work in such case due to multiple connections. Such scenarios require an IPPBX or a SIP Proxy to accomplish the tasks.

If remote access is required, a router with internet access should be added to the below-needed equipment list:

- o Several GDS370x
- o UCM6XX or another SIP Server
- o Grandstream IP Phones
- o PoE Switch with related Cat5e/Cat6 wiring
- o Electronic Lock

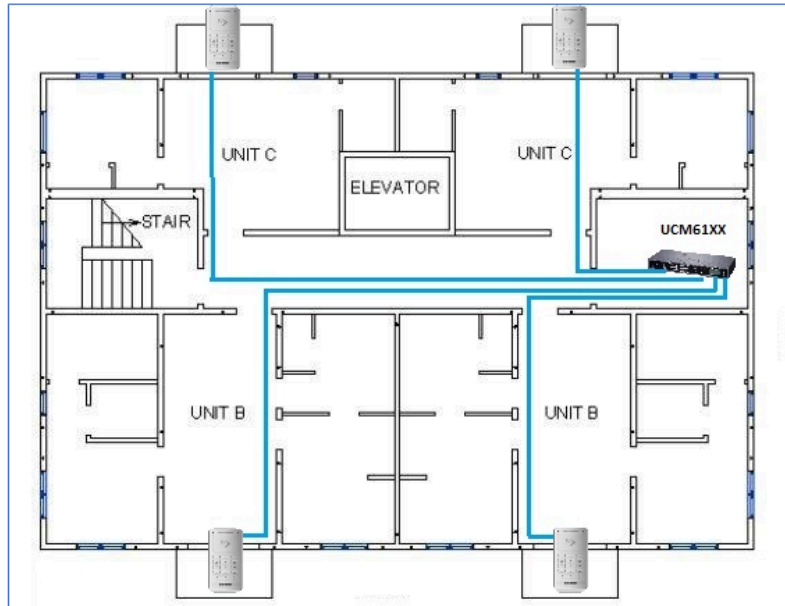

Peering GDS3705 with UCM6XXX

GDS370x PERIPHERAL CONNECTIONS

Below is the illustration of GDS370x peripheral connections for related applications.



Peripheral Connections for GDS370x

Alarm IN/OUT

Alarm_In could use any 3rd party Sensor (like IR Motion Sensor).

Alarm_Out device could use 3rd party Siren, Strobe Light, or Electric Door Striker, etc.

The figure below shows an illustration of the Circuit for Alarm_In and Alarm_Out.

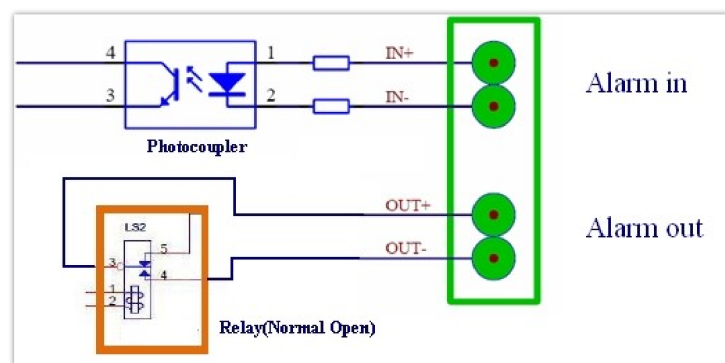

Alarm_In/Out Circuit for GDS370x

Notes:

- The Alarm_In and Alarm_Out circuit for the GDS370x should meet the following requirement:

Alarm Input	3V < V _{in} < 15V, PINs (1.02KΩ)
Alarm Output	125VAC/0.5A, 30VDC/2A, Normal Open, PINs

- The Alarm_In circuit, if there is any voltage change between 3V and 15V, as specified in the table above, the GDS370x Alarm_In port will detect it and trigger the action and event.
- Higher voltage and wrong polarity connections are prohibited because this will damage the devices.

Protection Diode

When connecting the GDS370x to a door strike it is recommended to set an EMF protection diode in reverse polarity for secure use, below are examples of deployment for the protection diode.

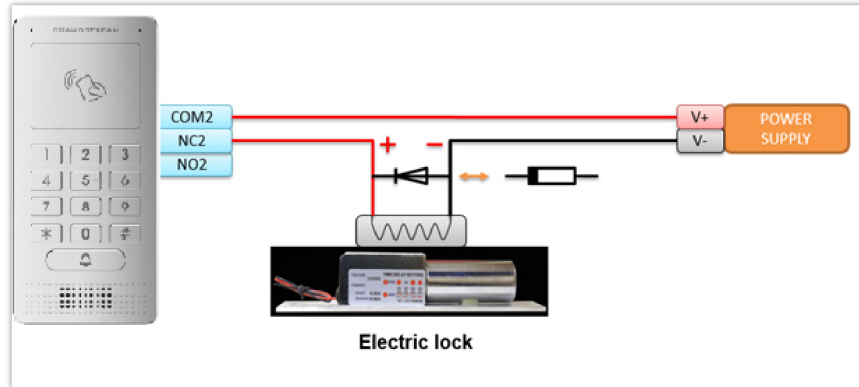

Protection Diode – Example 1

The reverse EMF protection diode must always be installed in reverse polarity across the door strike.

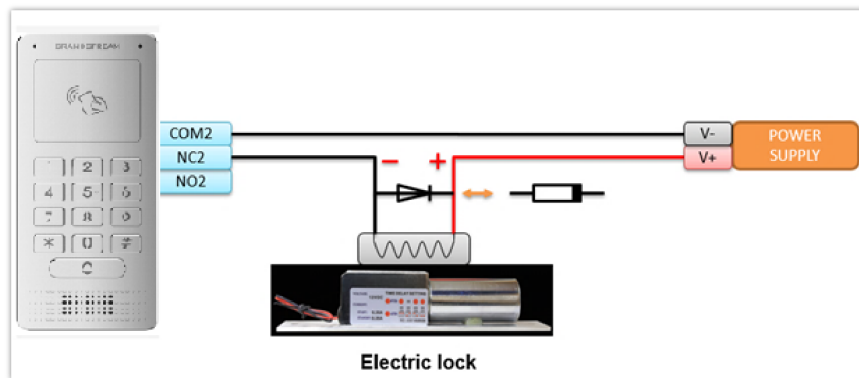

Protection Diode – Example 2

Connection Examples

Below are examples, show how to use wiring on the back cover of the GDS370x to connect with external devices. The "NO" (Normal Open) model strike is used as an example, "NC" (Normal Closed) should be similar and users need to decide which model (NO or NC) to be used on the door.

Wiring Sample using 3rd Party Power Supply

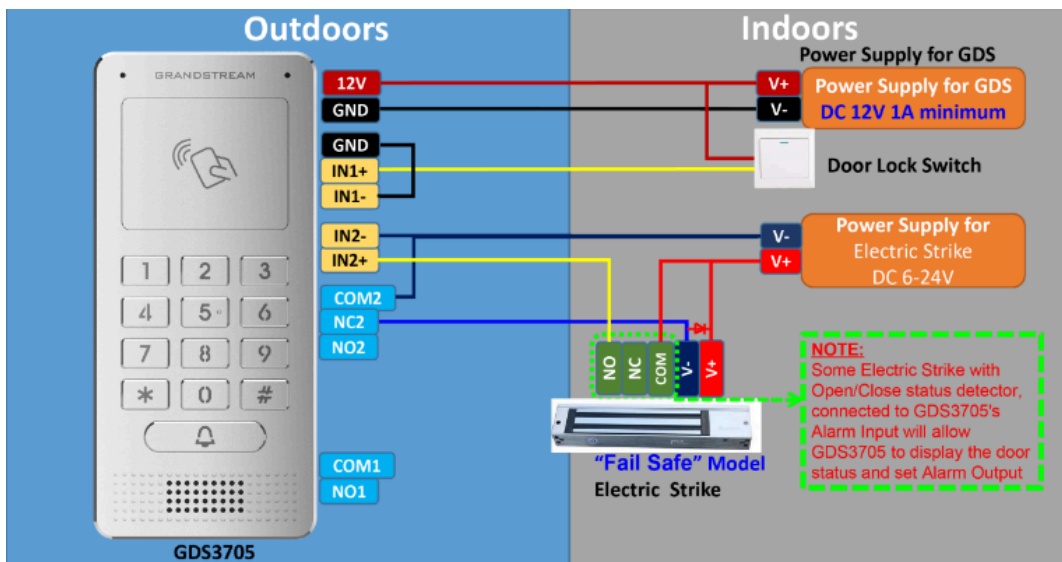

3rd party Power Supply Wiring Sample

Wiring Sample using Power Supply for both GDS370x and Electric Strike

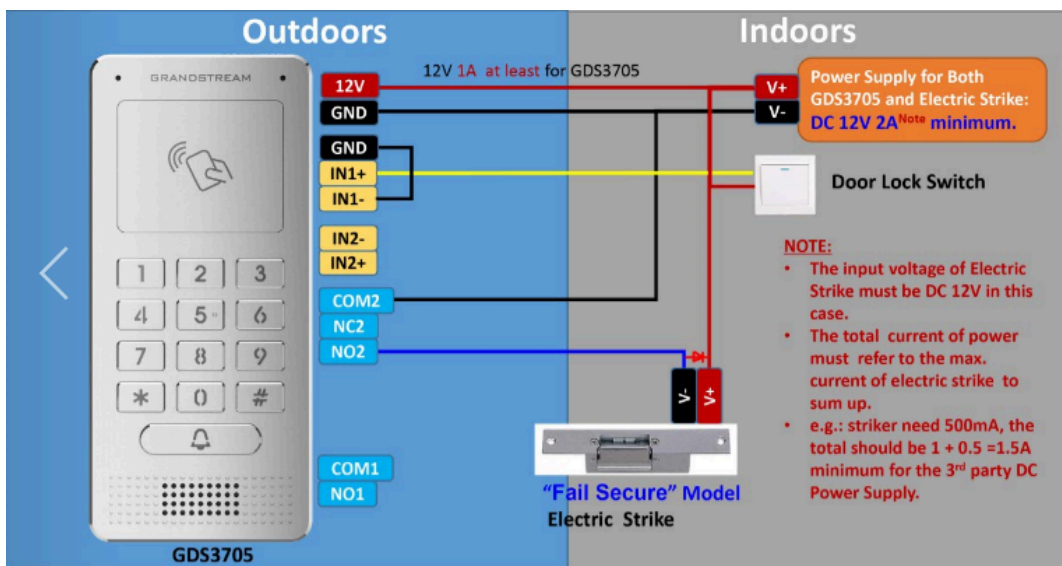

Power Supply used for both GDS370x and Electric Strike

Wiring Sample using PoE to power GDS370x and 3rd Party Power Supply for Electric Strike

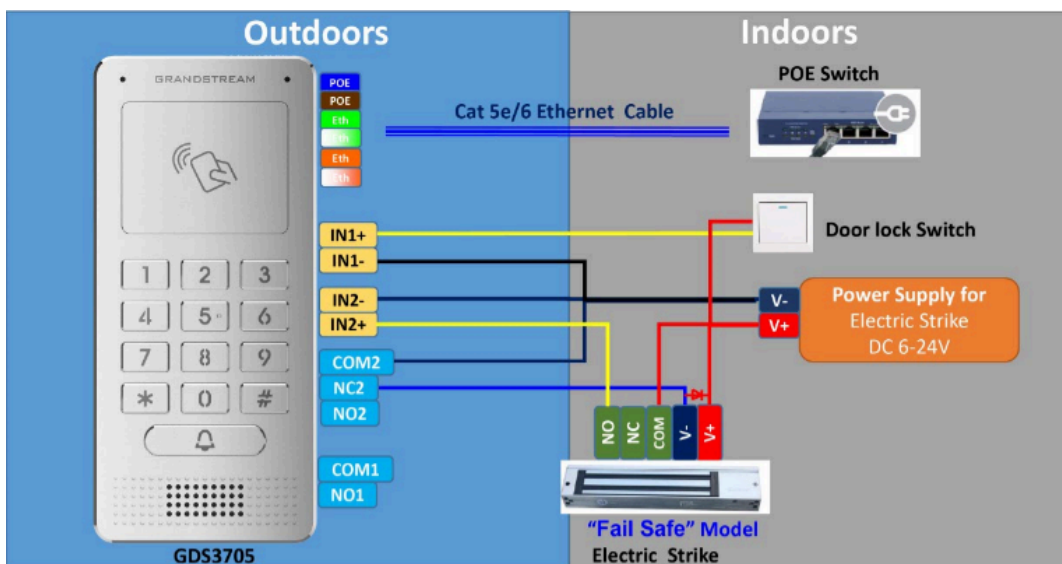

Wiring Sample using PoE to power GDS370x and 3rd party Power Supply for Electric Strike

Warning

The following example should be avoided when powering the electric strike.

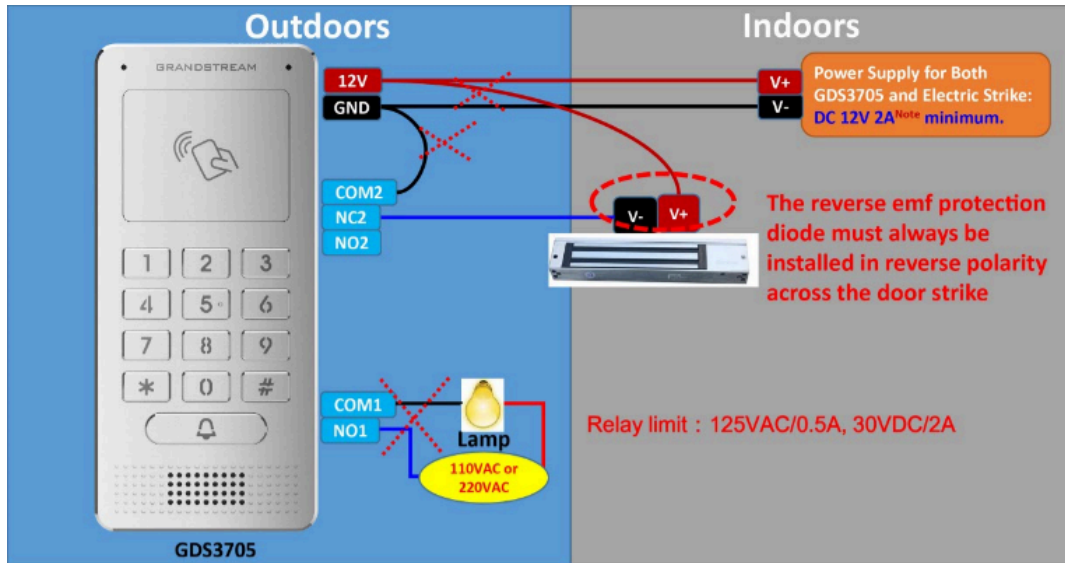

Example to Avoid when Powering the Electric Strike

Good Wiring Sample for Electric Strike and High-Power Device

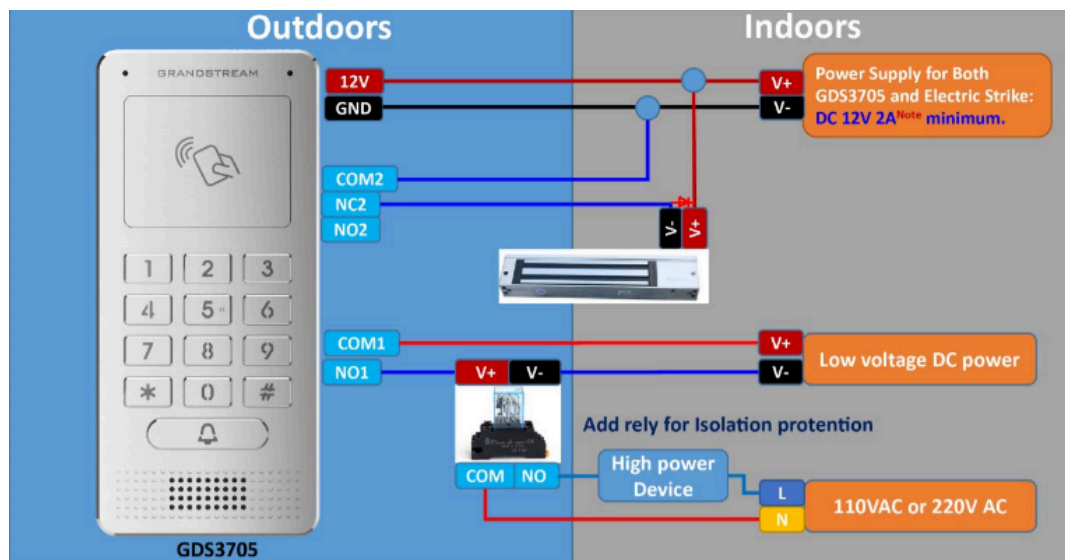

Electric Strike and High-Power Device Example

Wiegand Module Wiring Examples

GDS370x package is shipped with one Wiegand cable for Input/Output Wiegand connections. The following examples show how to connect the Wiegand Input/Output devices to the GDS370x.

Input example with 3rd party power supply for Wiegand device

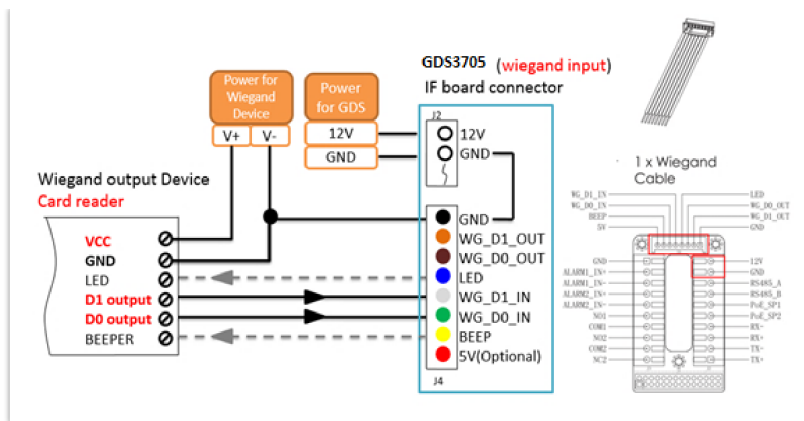

Wiegand Input Example with 3rd party Power Supply

Make sure to connect the GND of the Wiegand device and the GDS370x Wiegand port.

For Wiegand input mode, LED and Beep pins require that the Wiegand device support those interfaces. These two pins will not affect the Wiegand bus when not connected.

Input example with power supply for both GDS370x and Wiegand device

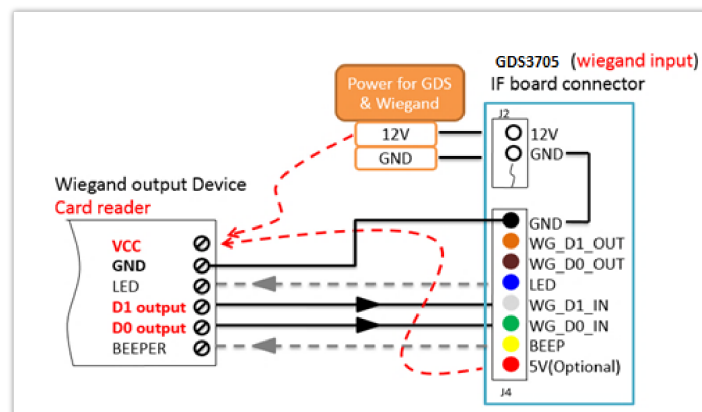

Wiegand Input Example with Power Supply for GDS370x and Wiegand Device

If the power source is 12VDC, the Wiegand device can share the same power source as GDS370x. However, users need to check the max power consumption and the max capability of the power source.

If Wiegand device is using 5VDC, GDS370x Wiegand port can provide 5VDC with max 500mA to power up Wiegand device.

Output example with 3rd party power supply for Wiegand device

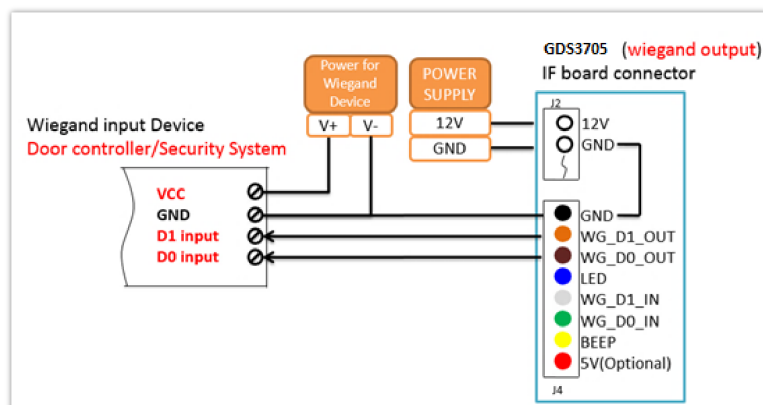

Wiegand Output Wiring Example

When the Wiegand output of the GDS370x is connected, it acts as the signal receiver of the 3rd party Wiegand device, connecting to the door controller. The major wiring is GND, D0, and D1. Because usually, the door controller will consume a big current and power, the power supply should be separated.

Wiegand RFID Card Reader Example

Note

The RFID card scan on the GDS is supported only on the GDS3705 Model.

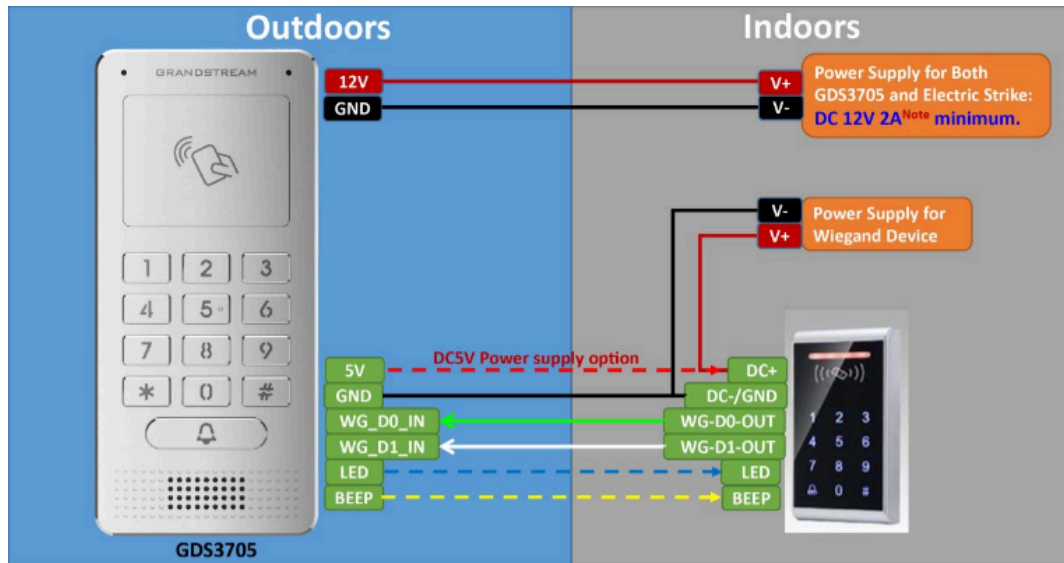

Wiegand RFID Card Reader Example

Siren alarming when the door opened abnormally

When this feature is enabled (special wiring required, see below wiring diagram), an abnormal open door will be detected by the DI port (Alarm_In2 or IN2 in the below diagram showed) if wired correctly (connecting the COMx port to Dlx port) therefore trigger the siren alarm. Once an abnormal open door alarm is triggered, the siren will sound non-stop, until manually overridden by a related person.

There are several ways to stop and disable the alarm:

1. Power cycle the GDS370x
2. Pick up the Alarm Phone Call (if configured)
3. Open Door using a PIN (either public PIN or private PIN) for the GDS3705 Model only.

Once the alarm is triggered, the GDS370x will play a siren sound, send an email to the administrator (if configured SMTP); call the configured alarm SIP phone, and send the alarm output (if connected). Users will only be able to disable the siren using the 3 methods mentioned above.

For detailed action information please refer to GDS37xx User Manual, "Alarm Action Settings" configuration. Below are some diagrams showing the correct wiring to enable this new security enhancement feature.

GDS370x Connection: IN2 set as Normal Close and "Fail-Safe" Electric Strike using 3rd Party Power Supply

Digit Input	
Digit Input 1	Abnormal Door Control
Digit Input 1 Abnormal Door Control Options	<input checked="" type="radio"/> Door 1 <input type="radio"/> Door 2
Digit Input 1 Status	Normal Close Current state is OPEN

Digital Input set as Normal close

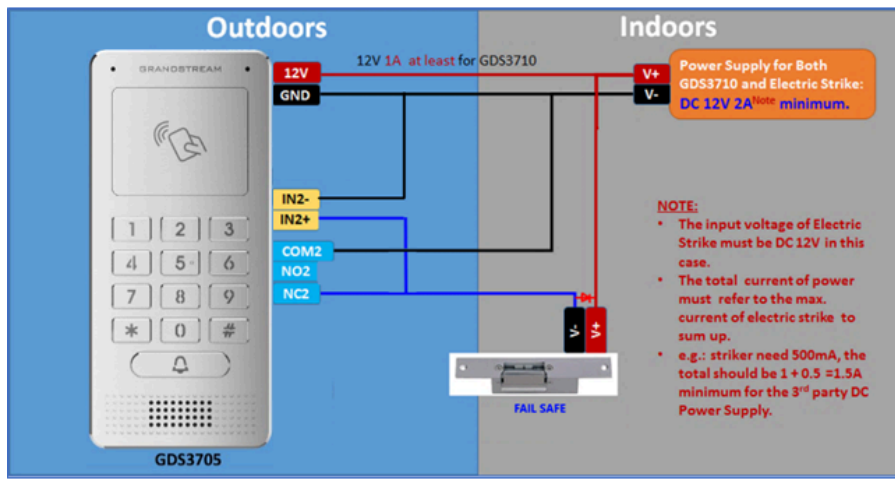

"Failsafe" Electric Strike using 3rd Party Power Supply

GDS370x Connection: IN2 set as Normal Open and "Fail Secure" Electric Strike using 3rd Party Power Supply

Digit Input	
Digit Input 1	Abnormal Door Control
Digit Input 1 Abnormal Door Control Options	<input checked="" type="radio"/> Door 1 <input type="radio"/> Door 2
Digit Input 1 Status	Normal Open

Digital Input set as Normal open

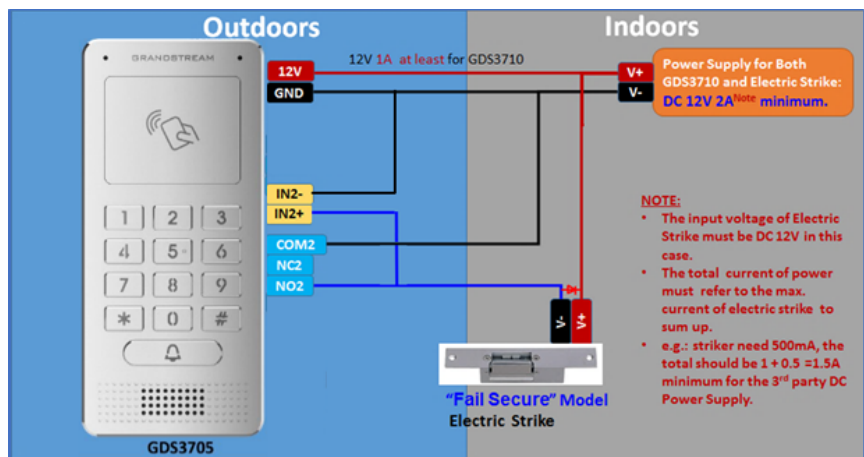

"Fail Secure" Electric Strike using 3rd Party Power Supply

Open Door via GDS370x with or without a SIP Call

This feature needs related matching GDS370x firmware to work. The minimum firmware version needed:

- o **GDS370x: 1.0.1.16 or higher.**

From the GDS3705 side, the configuration is the same. The only difference is the number of doors to be controlled: If using Local Relay controlled by GDS3705, TWO DOORS can be controlled.

If using GSC3570 Relay, ONLY ONE DOOR can be controlled. The PIN and other settings are the same as SIP remote open door or GSC3570 secure open door.

The difference will come out in the touch screen UI operation of GSC3570.

Door System Settings

- Door System Settings
 - Basic Settings
 - Keep Door Open
 - Card Management
 - Group
 - Schedule
 - Holiday
 - System Settings
 - Account
 - Phone Settings
 - Audio Settings
 - Alarm Settings
 - Email Settings
 - Maintenance
 - Status

Door Relay Options	Local Relay
ALMOUT1 Feature	Open Door
ALMOUT1 Status	Normal Open
Control Options	<input checked="" type="checkbox"/> Door 1 <input checked="" type="checkbox"/> Door 2
Wiegand Control	<input type="checkbox"/> Door 1 <input type="checkbox"/> Door 2
Door 1 Delay before Unlock(s)	0
Door 2 Delay before Unlock(s)	0
Door 1 Unlock Holding Time(s)	5
Door 2 Unlock Holding Time(s)	5
Minimum Interval of Swiping Card(ms)	300
Call Mode	SIP Number
Doorbell Mode	Call Doorbell Number
Doorbell Call Out Account	Auto
Door Bell Call Mode	Serial Hunting
Number Called When Door Bell Pressed	192.168.5.208:5060
Remote PIN to Open Door 1	*****
Remote PIN to Open Door 2	*****

GDS3705 Configuration Example

Settings Grandstream Door System

Order	Service Type	Account	System Identification	System Number	System IP Address	Door 1 Name	Door 1 Access Password	Door 2 Name	Door 2 Access Password
1	GDS	Account 1	GDS3705	192.168.5.225	192.168.5.225	Door1	***	Door2	***
2	GDS	Account 1							
3	GDS	Account 1							
4	GDS	Account 1							
5	GDS	Account 1							
6	GDS	Account 1							
7	GDS	Account 1							
8	GDS	Account 1							
9	GDS	Account 1							
10	GDS	Account 1							

Save Save and Apply Reset

GSC3570 Configuration Example

Door opening with SIP Call

When GSC3570 established a call with GDS370x, the screen will display the virtual open door button(s), and the user will press the button to open the door:

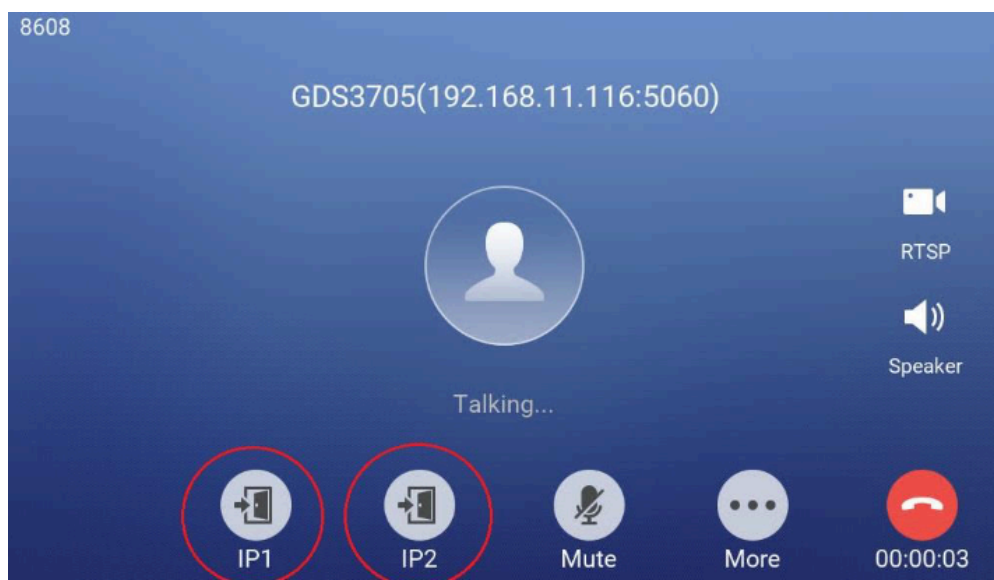

Door opening without SIP Call

At the GSC3570 idle screen, press "Monitor →Door system", and the related GDS370x will be displayed. In the blue bar, left is a "Phone" icon and right is the "Open door" icon. The "Phone" icon will establish the SIP call as the previous firmware behaved.

Press the "Open door" icon, and the GSC3570 will open the door directly and NO SIP CALL will be established. Depending on how many doors are controlled, if one door is configured, the door will open directly; if two doors are configured, another screen will pop up to allow the user to choose which door to open, as shown below:

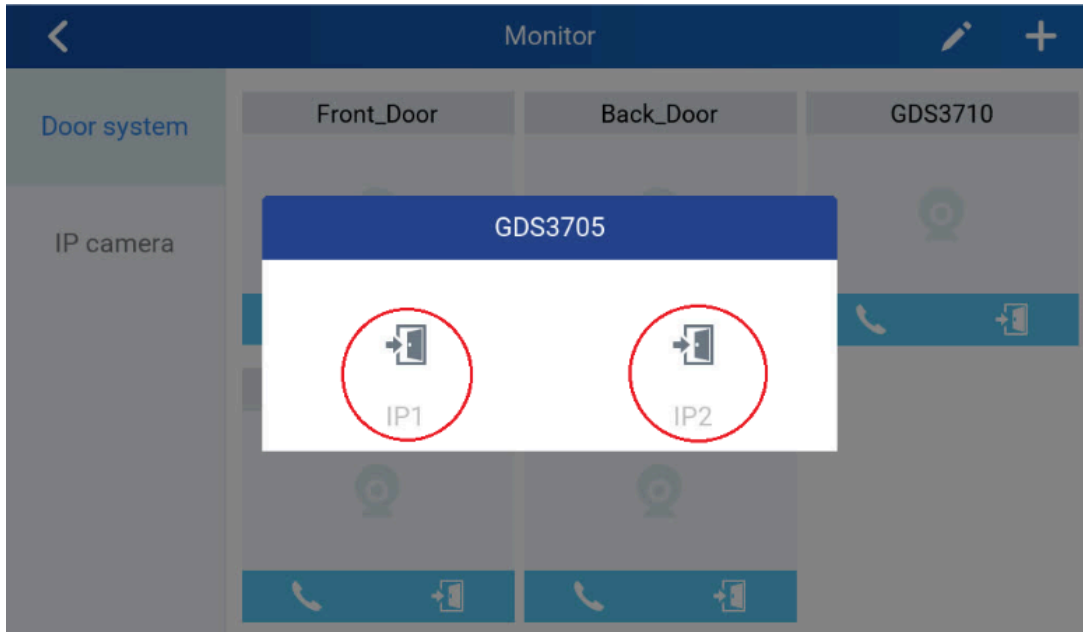

Open Door without SIP Call

When the door is successfully opened the following message will appear:



Open Door without SIP Call

Secure Open Door Peering with GSC3570

Secure open door feature is a pairing scenario that is done between the GSC3570 control station and the GDS37xx door system, with GDS37xx installed outside, the GSC3570 is installed inside, the strike or lock is wired directly to the Alarm_Out interface of GSC3570 to control the door from inside, therefore more secure compared to the strike wired directly to GDS37xx outside. Below is the application scene illustration:

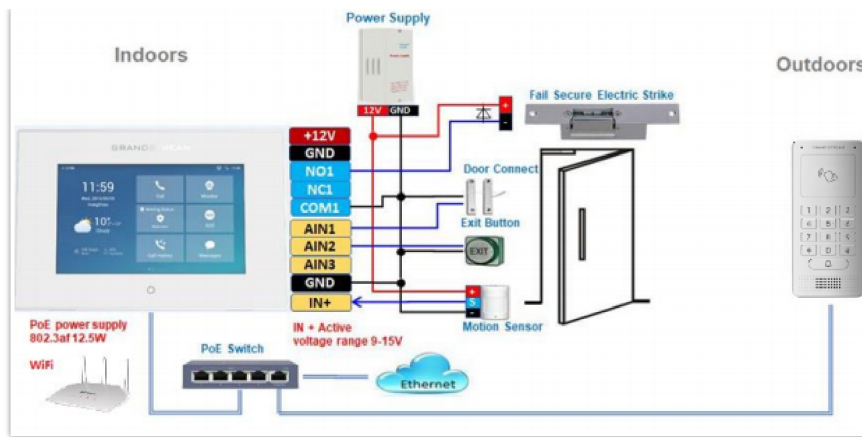

GSC3570 secure open door via GDS3705

Notes

Some considerations before configuring the Secure Open Door Peering with GDS37xx:

- GDS371x firmware 1.0.7.19 or above / GDS370x firmware 1.0.1.13 or above, are required to work with GSC3570.
- Only one door can be controlled by the GSC3570 since it has only one Relay Control circuit.
- If multiple doors need to be controlled by the GSC3570, then a SIP call is required, and the door strike/relay should be controlled by the related GDS37xx directly.
- The GSC3570 will turn on LCD when device in energy save mode (LCD Off) when secure open door event happened.
- When receiving an incoming call, a 3rd party audio/light strike device can be triggered by Door Open Port when wired properly on the GSC3570 side.
- When implementing secure open door, the door relay mode should be set to GSC3570 Relay.
- When configured correctly, the GSC3570 Secure Open Door will function with all GDS37xx open door mode: RFID card, Local PIN, Remote PIN (SIP Call or DTMF Open Door).
- RFID card can be used only on the GDS3710, and GDS3705 models.
- When using IP peering the SIP Transport must be set to "UDP"
- When using IP Peering, static IP address in same LAN must be used and the related Account need to configure "No" in the NAT Traversal.
- Remote open door without being in SIP direct IP is supported only on GDS3710/GDS3712 models.

Please refer to the following configuration guide to learn more about setting up Secure Open Door Peering with GDS37xx:
[Peering GDS with GSC3570](#)

GDS370x HOME WEB PAGE

- Once the IP address of the GDS370x is entered on the user browser, the login web page will pop up allowing the user to configure the GDS370x parameters.
- When clicking on the "Language" drop-down, supported languages will be displayed as shown in the Figure below. Click to select the related webpage display language.

GDS3705

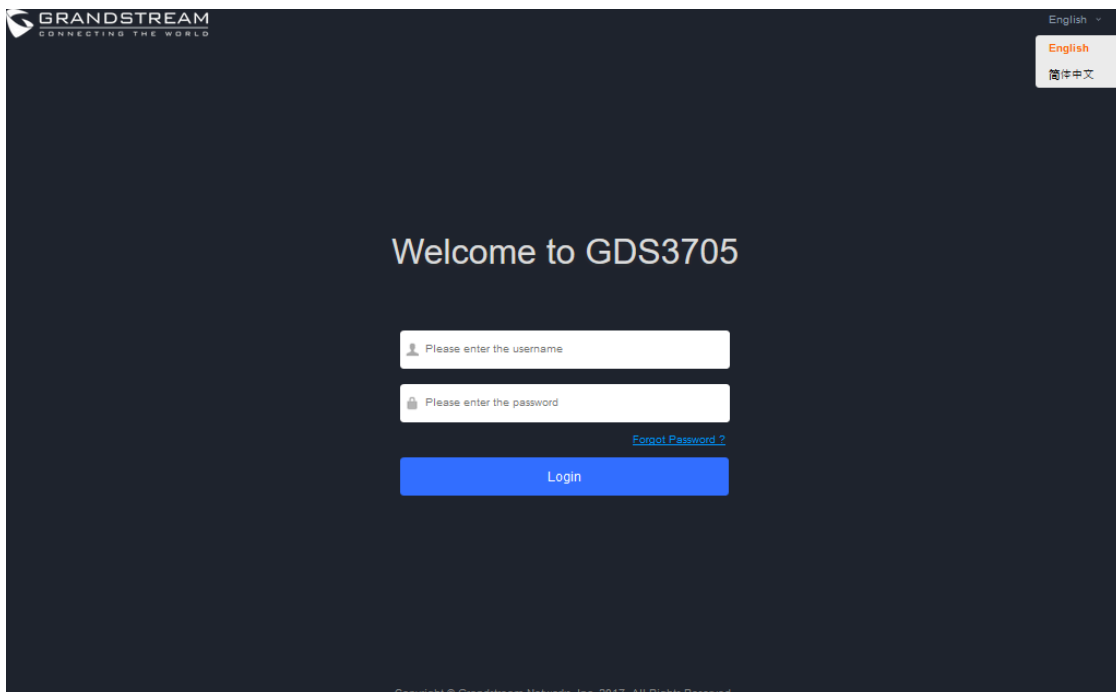

Change Language Page on GDS3705

GDS3702

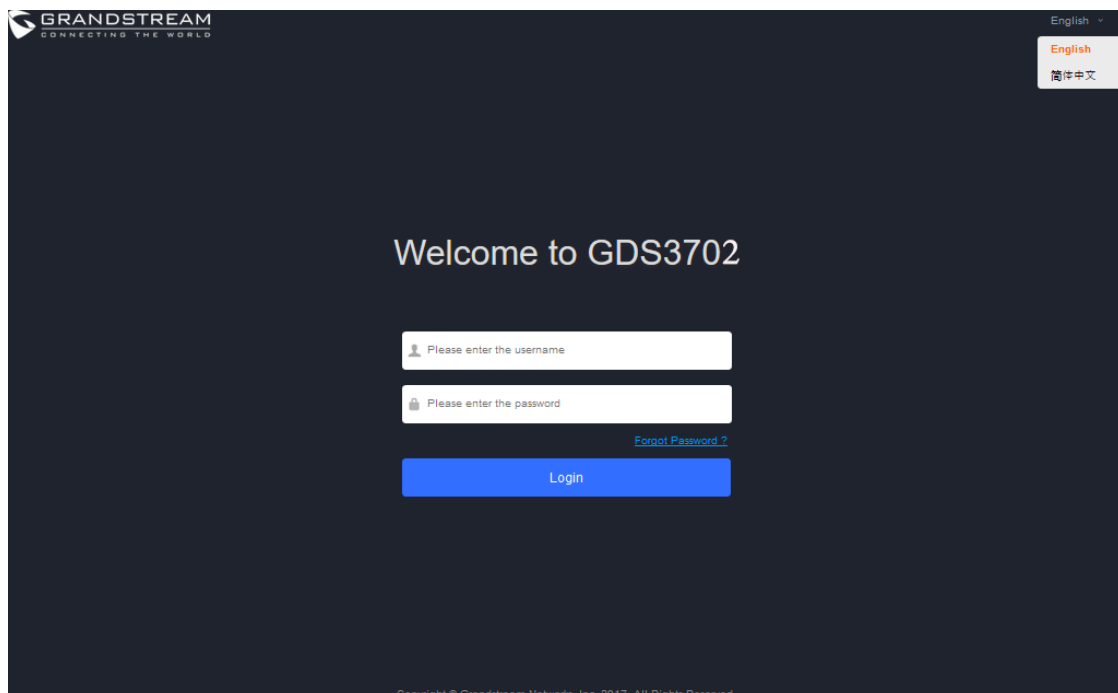

Change Language Page on GDS3702

Note

Current firmware supports only English (default) and simplified Chinese.

GDS370x SETTINGS

Door System Settings

Users can configure system operations parameters, like input PIN for the door (GDS3705 Model only), and manage users' settings.

Basic Settings

Door System Settings Page

<p>Door Relay Options</p>	<p>There are three choices in the pull-down selection: Local Relay, Webrelay and GSC3570.</p> <ul style="list-style-type: none"> • Local Relay: Local Relay is the GDS3705 controlling the relay. The strike is wired into the COM2 or COM1 port of the GDS3705 depending 1 door or 2 door need to be controlled. • Webrelay: When Webrelay is selected, customers need to continue configure the webrelay IP address or domain name, together with credentials like Username and Password. When legal open door event happened, the configured web relay will get the communication from GDS3705, and will operate the strike to open door for the authenticated open door request. • GSC3570 Relay: When the Door relay is set to GSC3570, it gives the option to connect it to the GSC3570 device by entering the Phone number and door password <p>Note: In web relay mode, the strike is wired to the web relay controller device.</p>
<p>Webrelay On URL</p>	<p>When Door relay Option set to Webrelay, then enter the correct URL used by the third party controller so that the GDS370x send the command to activate the relay. This adds an extra layer of security so when legal open door event happened, the configured web relay will get the communication from GDS370x, and will operate the strike to open door for the authenticated open door request or use that command to operate other industry application.</p> <p>Notes:</p> <ul style="list-style-type: none"> • Now there are two Webrelay URL fields available, with On or Off URL command allowed or other usage URL command allowed. Also allow Username and Password configured if the 3rdparty Webrelay requiring this security feature. • If some 3rd party Webrelay only support one URL command, then just leave another Off URL blank, or put whatever there as long as it is NOT a URL command.
<p>Webrelay Off URL</p>	<p>When Door relay Option set to Webrelay, then enter the correct URL used by the 3rd party controller so that the GDS3705 send the command to disable the relay.</p>
<p>Webrelay Username</p>	<p>Enter the web relay username.</p>
<p>Webrelay Password</p>	<p>Enter the web relay password.</p>
<p>ALMOUT1 Feature</p>	<p>This option allows to choose to use Alarm_Out (COM1) interface for either as alarm out with 3rd party device, or to control a second door “Door 2” (the two functions are mutual exclusive).</p>

	When option “Open Door” is selected, will enable GDS3705 to control the operation of two doors via RFID, local and remote PINs.
ALMOUT1 Status	Select Normal Open or Normal Close depending on the lock used.
Delay before Unlock (s)	Device will open door after specified delay (in seconds) when user issuing the authorization.
Unlock Holding Time (s)	Configures the lock holding time, in seconds (default value is 5 seconds). Device will hold the door unlocked for this specified duration. Range: 1-1800 seconds.
Minimum Interval of Swiping Card (ms)	Defines the interval in ms to swipe consecutive RFID cards. The range should be between 0ms and 2000ms. Default 300 ms. Note: Configuration available only on the GDS3705.
GSC3570 Phone Number	Incase of choosing a GSC3570 Relay , the Phone number of the GSC3570 needs to be defined on this field.
GSC3570 Door Password	Incase of choosing a GSC3570 Relay , the Door Password of the GSC3570 needs to be defined on this field.
Call Mode	Chooses whether to make call to the SIP number or Virtual Number when dialing from the GDS3705 keypad. Note: Configuration only for the GDS3705 Model.
Doorbell Mode	Configures the action to be taken when the doorbell is pressed, three options are available: <ul style="list-style-type: none"> ● Call Doorbell Number: when Doorbell is pressed, a call will be made to the “Number Called When Door Bell Pressed”. *This option will be the only available when ALMOUT1 Feature is set to Open Door. ● Control Doorbell Output (Digital Output 1): when Door Bell is pressed electronic lock for Output 1 is opened. ● Both of Above: When selected, both Call Doorbell Number and Control Doorbell Output options are enabled.
Doorbell Call Out Account	This option sets the account to be used to make call upon the doorbell trigger. If set to Auto, the GDS will use the first available account.
Door Bell Call Mode	Select the ring strategy for the Numbers Called when pressing the Door Bell button to be either Serial or Parallel : <ul style="list-style-type: none"> ● Serial Hunting: the configured extensions and/or IP addresses will ring one after one by order. ● Parallel Hunting: The configured extensions and/or IP addresses will ring simultaneously (up to 4 simultaneous SIP calls).
Press Doorbell Schedule 1	Sets the first doorbell schedule , the device will verify if current time fits in the schedule , if yes it will dial out using the configured number in the field "Number 1 Called When Doorbell Pressed"
Number 1 Called When Door Bell Pressed	Configures SIP extension number (SIP Server mode), or IP address with port number (peering mode), to be called when the Door Bell is pressed: <ul style="list-style-type: none"> ● SIP Server Mode: <ul style="list-style-type: none"> ○ The field can be configured to store multiple one or multiple SIP extensions, if configured with multiple extensions (ex: 1001, 1002, 1003), separated with “,” the GDS3705 will ring one extension after the other in a Serial Hunting Mode (GDS will ring each extension by default 15 seconds, this can be changed on the Ring Timeout) or ring them simultaneously in Parallel Hunting Mode.

	<ul style="list-style-type: none"> ○ When using UCM, users can also configure there a Ring Group extension (6400 for example) that will ring multiple extensions simultaneously, or one by one depending on the Ring Group ring strategy ○ If all phones are GXP21XX, users can open door either by pressing Remote_PIN# or by pressing Open Door button if already configured. ○ If early medial is enabled on phone side, user can send the PIN code using the Open-Door button before answering the call (Of course users can open the door also after answering the call). <p>● Peering Mode:</p> <ul style="list-style-type: none"> ○ User should configure multiple IP addresses of phones instead of SIP extensions, when Door Bell pressed the GDS3705 will ring the configured IP Addresses in Serial or Parallel Mode according to Doorbell Call Mode strategy. <p>Note: This field supports a Maximum of 256 characters. Note: The latest firmware version 1.0.3.11 now supports configuring different "Number Called When Door Bell Pressed" entries depending on the time frame.</p>
<p>Press Doorbell Schedule 2</p>	<p>Sets the second doorbell schedule , the device will verify if current time fits in the schedule , if yes it will dial out using the configured number in the field "Number 2 Called When Doorbell Pressed"</p>
<p>Number 2 Called When Door Bell Pressed</p>	<p>Configures SIP extension number (SIP Server mode), or IP address with port number (peering mode), to be called when the Door Bell is pressed:</p> <p>SIP Server Mode:</p> <p>The field can be configured to store multiple one or multiple SIP extensions, if configured with multiple extensions (ex: 1001, 1002, 1003), separated with “;” the GDS370x will ring one extension after the other in a Serial Hunting Mode (GDS will ring each extension by default 15 seconds, this can be changed on the Ring Timeout) or ring them simultaneously in Parallel Hunting Mode.</p> <p>When using UCM, users can also configure there a Ring Group extension (6400 for example) that will ring multiple extensions simultaneously, or one by one depending on the Ring Group ring strategy</p> <p>If all phones are GXP21XX, users can open door either by pressing Remote_PIN# or by pressing Open Door button if already configured on the GDS3705 Model only.</p> <p>If early medial is enabled on phone side, user can send the PIN code using the Open-Door button before answering the call (Of course users can open the door also after answering the call).</p> <p>Peering Mode:</p> <p>User should configure multiple IP addresses of phones instead of SIP extensions, when Door Bell pressed the GDS370x will ring the configured IP Addresses in Serial or Parallel Mode according to Doorbell Call Mode strategy.</p> <p>Note: This field supports a Maximum of 256 characters. Note: The latest firmware version 1.0.3.11 now supports configuring different "Number Called When Door Bell Pressed" entries depending on the time frame.</p>
<p>Press Doorbell Schedule 3</p>	<p>Sets the third doorbell schedule , the device will verify if current time fits in the schedule , if yes it will dial out using the configured number in the field "Number 3 Called When Doorbell Pressed"</p>
<p>Number 3 Called When Door Bell Pressed</p>	<p>Configures SIP extension number (SIP Server mode), or IP address with port number (peering mode), to be called when the Door Bell is pressed:</p> <p>SIP Server Mode:</p> <p>The field can be configured to store multiple one or multiple SIP extensions, if configured with multiple extensions (ex: 1001, 1002, 1003), separated with “;” the GDS370x will ring one extension after the other in a Serial Hunting Mode (GDS will ring each extension by default 15 seconds, this can be changed on the Ring Timeout) or ring them simultaneously in Parallel Hunting Mode.</p> <p>When using UCM, users can also configure there a Ring Group extension (6400 for example) that will ring multiple extensions simultaneously, or one by one depending on the Ring Group ring strategy</p> <p>If all phones are GXP21XX, users can open door either by pressing Remote_PIN# or by pressing Open Door button if already configured on the GDS3705 Model only.</p> <p>If early medial is enabled on phone side, user can send the PIN code using the Open-Door</p>

	<p>button before answering the call (Of course users can open the door also after answering the call).</p> <p>Peering Mode: User should configure multiple IP addresses of phones instead of SIP extensions, when Door Bell pressed the GDS370x will ring the configured IP Addresses in Serial or Parallel Mode according to Doorbell Call Mode strategy. Note: This field supports a Maximum of 256 characters. Note: The latest firmware version 1.0.3.11 now supports configuring different "Number Called When Door Bell Pressed" entries depending on the time frame.</p>
Press Doorbell Schedule 4	<p>Sets the fourth doorbell schedule , the device will verify if current time fits in the schedule , if yes it will dial out using the configured number in the field "Number 4 Called When Doorbell Pressed"</p>
Number 4 Called When Doorbell Pressed	<p>Configures SIP extension number (SIP Server mode), or IP address with port number (peering mode), to be called when the Door Bell is pressed:</p> <p>SIP Server Mode: The field can be configured to store multiple one or multiple SIP extensions, if configured with multiple extensions (ex: 1001, 1002, 1003), separated with “;” the GDS370x will ring one extension after the other in a Serial Hunting Mode (GDS will ring each extension by default 15 seconds, this can be changed on the Ring Timeout) or ring them simultaneously in Parallel Hunting Mode. When using UCM, users can also configure there a Ring Group extension (6400 for example) that will ring multiple extensions simultaneously, or one by one depending on the Ring Group ring strategy If all phones are GXP21XX, users can open door either by pressing Remote_PIN# or by pressing Open Door button if already configured on the GDS3705 Model only. If early medial is enabled on phone side, user can send the PIN code using the Open-Door button before answering the call (Of course users can open the door also after answering the call).</p> <p>Peering Mode: User should configure multiple IP addresses of phones instead of SIP extensions, when Door Bell pressed the GDS370x will ring the configured IP Addresses in Serial or Parallel Mode according to Doorbell Call Mode strategy. Note: This field supports a Maximum of 256 characters. Note: The latest firmware version 1.0.3.11 now supports configuring different "Number Called When Door Bell Pressed" entries depending on the time frame.</p>
Remote PIN to Open the Door	<p>Configures PIN code stored in the GDS3705, remote SIP phone needs to input and match this PIN (the PIN is sent via DTMF while in call) so that the GDS3705 can open the door. Note: For enhanced security, when the call is initiated from GDS then only the numbers existing in “White List” will be able to use DTMF PIN to open door remotely. Note: This configuration is available only on the GDS3705 Model.</p>
Maximum Number of Dialed Digits	<p>Configure the maximum digits allowed to dial in the keypad. Once the configured condition is satisfied, the device will automatically send the number to call without pressing #. It is disabled if set to 0. Note: Configuration can be done only on the GDS3705.</p>
No Key Input Timeout (s)	<p>Defines the timeout (in seconds) for no key entry. If no key is pressed after the timeout, the digits will be sent out without pressing #. The default value is 4 seconds. The valid range is from 1 to 15. Note: Configuration can be done only on the GDS3705.</p>
Local PIN Type	<p>Three options are available: Private Card PIN, Unified PIN or Card and Private PIN.</p> <ul style="list-style-type: none"> ● Private PIN: Means every member has a private PIN, the GDS will record who unlocked the door every time. Users need to enter the following sequence from the GDS3705 to open the door [*Virtual Number*Private PIN#]. <p><u>Notes:</u></p> <ol style="list-style-type: none"> 1. When Local PIN type is set to private PIN, users can also open the door by swiping their cards.

	<p>2. If “Disable Keypad SIP Number Dialing” is checked, users will be able to open door using private PIN with following sequence [Private PIN#].</p> <p>Note: Door can still be opened by Card and with the sequence [*Virtual Number*Private PIN#].</p> <ul style="list-style-type: none"> • Unified PIN: Means all members share a same PIN to unlock the door. Users need to enter the following sequence from the GDS3705 keypad to open the door [*Local PIN to Open Door#]. • Card & Private PIN: Means every member needs to swipe his card and enter his private PIN to open the door using the following sequence [Swipe the card + * Private PIN#]
Local PIN to Open Door	<p>Configures PIN stored in GDS3705, input locally this PIN on the GDS3705 keypad will unlock the door.</p> <p>This feature needs Private PIN, means every member has a private PIN, the GDS will record who unlocked the door every time.</p> <p>Users need to enter the following sequence from the GDS3705 to open the door [*Virtual Number*Private PIN#].</p> <p>Note: When local PIN type is set to private card PIN, users can also open the door by swiping their cards.</p>
Local PIN to Open Door Schedule	<p>Configure a schedule for the Local PIN to open the door for “Unified PIN” mode only. Once configured, the door opening ability using local PIN with turn ON/OFF based on configured schedule. The schedule can ONLY be edited when “Central Mode” disabled.</p> <p>Notes: If “Central Mode” enabled, the “Schedule” page cannot be edited. (a green “Central Model” label will display in top right corner of the UI).</p> <p>When “Central Mode” enabled, the “Schedule” will be edited in GDSManager and synchronized by pulling from GDSManager down to GDS3705 device.</p> <p>Default setting is “All Day”.</p>
Enable DTMF Open Door	<p>When enabled, remote SIP phones can open the door while in call by entering the remote PIN code configured (the PIN code is sent via DTMF). Default settings is disabled.</p>
Enable Guest PIN	<p>Enables password entry for guests.</p>
Guest PIN	<p>Configures the password that will be used by guests</p>
Guest PIN Start Time	<p>Selects the start time when the Guest PIN start to take effect.</p>
Guest PIN End Time	<p>Selects the end time when the Guest PIN will stop working.</p>
Disable Auto Answer	<p>If checked, GDS3705 will not answer incoming calls automatically, users can press any key to answer the call.</p> <p>Default setting in unchecked.</p>
Enable Doorbell Button to End Call	<p>If checked, Users can hang up an active call when pressing the doorbell button. Enabled by Default.</p>
Disable Keypad (except the Doorbell Button)	<p>When checked the Keypad will be disabled, only Door Bell button can be pressed. Disabled by Default.</p>
Enable On Hook After Remote Door Opened	<p>When checked calls will be disconnected automatically 5 seconds after the remote open door event. Enabled by Default.</p>
Onhook Timer After Remote Open Door (s)	<p>When configured, the GDS37xx will keep the door unlocked for the configured period of time. The available range is "3-1800 seconds".</p> <p>Default is 3 seconds.</p>
Enable HTTP API Remote Open Door	<p>Enabling this option allows to use HTTP API command to open the door remotely.</p> <ul style="list-style-type: none"> • Disable: Disables remote door opening via HTTP API.

	<ul style="list-style-type: none"> ● Challenge + Response Authentication: Uses a secure method requiring the client to answer a server challenge correctly before opening the door. ● Basic Authentication: Uses a simpler method with a username and password encoded in the HTTP request header for authentication. <p>Notes:</p> <ol style="list-style-type: none"> 1. PIN Code via Wiegand is sent on the HTTP response when HTTP API open door is executed. 2. "X-Content-Type-Options", "HSTS(Strict-Transport-Security)", "X-XSS-Protection" headers are included in the HTTP response to enhance security. 3. GDS370x will automatically reset to its default state after an API command is used to open the door, after the door is opened, the system automatically resets itself (goes on hook). 4. Please refer to the GDS HTTP API guide for more information on the HTTP commands supported. <p>Important note: We will not be responsible for any security problems resulting from opening the HTTP API remote function, this option is disabled by default and the user should enable it while knowing how to mitigate the risk.</p>
HTTP API Open Door Compatibility Mode	Check to support HTTP API Open Door under HTTPS web access mode.
Disable Keypad SIP Number Dialing	<p>When Keypad SIP number Dialing disabled, device will interpret each digit entry as private-password open door request after pressing #.</p> <p>Notes:</p> <ul style="list-style-type: none"> ● “Local PIN Type” should choose “Private PIN”. ● Dial keypad to make SIP call will NOT work (except for doorbell button call). ● Private PIN must be UNIQUE among users, otherwise the door will still open but log will NOT tell who opened the door due to duplicated PIN and whoever user last matched in the database with the Private PIN will be shown in the log. <p>Note: Configuration can be done only on the GDS3705 Model.</p>
Enable Card Issuing Mode	<p>Enables RFID card issuing/program into the GDS3705. When selected sweeping an RFID card into the GDS3705 will add card information into [Card Management].</p> <p>Note: Configuration Exclusive to the GDS3705 Model.</p>
Card Issuing Mode Expired Timer(m)	Card issuing mode will be automatically disabled when timer reached (The range of value is 1 – 1440, in minutes). Default value is 5.
Enable Key Blue Light	When checked, the blue light will be activated when pressing the GDS3705 Keys.
Enable Doorbell Blue Light	When enabled, Keypad LED will light based on the configured Start/End Time. For instance, this option can be used when GDS is deployed on dark environment, the GDS will be located easily using Keypad LED. the Enable Doorbell Blue light can be scheduled by configuring a Start Time and End Time.
Enable Keypad Blue Light	<p>When enabled, Keypad LED (except for Doorbell LED) will light based on the configured Start/End Time. For instance, this option can be used when GDS is deployed on dark environment, the GDS will be located easily using Keypad LED. the Enable Keypad Blue light can be scheduled by configuring a Start Time and End Time.</p> <p>Note: Configuration exclusive to the GDS3705.</p>
Central Mode	<p>If enabled, Group/Schedule/Holiday/Keep Door Open, can only be synchronized from the Central (GDS Manager), local configuration will not be allowed.</p> <p>If disabled, only local configuration from GDS3705 is allowed.</p>
Key Tone Type	<p>Configures the key tones for the GDS3705.</p> <ul style="list-style-type: none"> ● Default: Beeps will be played when pressing the GDS3705 keys. ● DTMF: Tones will be played when pressing the GDS3705 keys. ● Mute: No sound will be played when pressing keys.

Enable Wiegand Input	This option needs to be enabled when GDS is connected to the wiegand. output device (RFID card reader for example)
Wiegand Output	This option is to be enabled when the GDS is the wiegand output device. (example: input device is a door controller)

Door System Settings

Note

Remote SIP phone needs a password (digits 0-9 only, ended with # key) matching the configuration on the web page to open the door via DTMF. (This feature is only supported on the GDS3705 Model)

GDS3705 support RFID for multiple users to open door, therefore every user has its own PIN. For an environment with 100 users and more, it's difficult for the GDS3705 to manage all these users and a separate PC or Server should be involved for such kind of management and monitoring.

In environments with more than 100 users the GDS3705, another possibility would be to set one unified Local PIN for opening the door for all the users.

Using Alarm Out (COM 1) to Control a Second Door

Note

The following configuration is exclusive to the GDS3705 Model.

Starting from firmware 1.0.0.41, the user can now set Alarm_Out (COM1) interface to control a second Door, in addition to the existing Locker/COM2 interface (controlling Door1).

This feature allows GDS3705 to control the operation of two doors via RFID, and local and remote PINs.

For example, a 3rd party Wiegand Input device or GDS3705 can be installed at Door2 with a related cable wired into the control GDS3705 installed at Door1. The Door1 and Door2 can be configured to be open by programmed RFID cards, and PINs either separately or both.

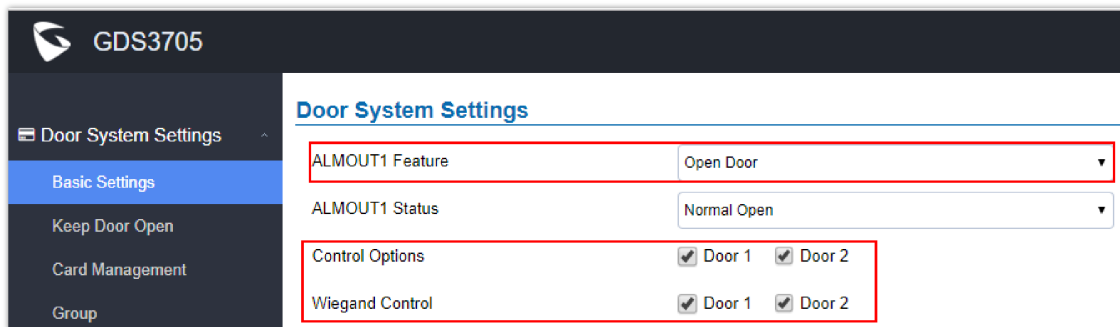

Alarm_Out1 Feature

o **Interface for Door Control (which Door can be OPEN):**

Note

The following configuration is exclusive to the GDS3705 Model.

If Alarm_Out (COM1) interface is set to control Door 2 opening, "ALMOUT1 Status" can be configured by choosing "Normal Open" or "Normal Close" based on the strike used.

Unlike the default COM2 which is designed for strike control and has three connecting sockets, COM1 only has two connecting sockets. Therefore correct lock mode has to be configured to make the strike work as expected.

For the above example, the GDS3705 is configured to control Door1 (wiring to COM2 interface); the 3rd party Wiegand Input is set to control Door2 (wiring to COM1 interface).

In case of a power loss then the DOOR STATUS when power is off will be depending on the following situations:

- COM2 has three wiring PINs, corresponding to NO or NC accordingly. Therefore when connecting NC2 and COM2 (Fail Safe) the strike will open when power is lost and when using a NO2 strike (connecting COM2 and NO2) the door is "locked" when power is lost (Fail Secure).
- COM1 (ALMOUT1) has only two PINs and NO ONLY. If the connected strike/lock is a NO strike, this means ALMOUT1 Status should be set to "Normal Open" then the door will be closed when power is lost, while if the strike connected is NC strike, and ALMOUT1 Status is set to "Normal Close" then the door will be open when power is lost.
- **Universal PIN for Operation of Doors:**

Note

The following configuration is exclusive to the GDS3705 Model.

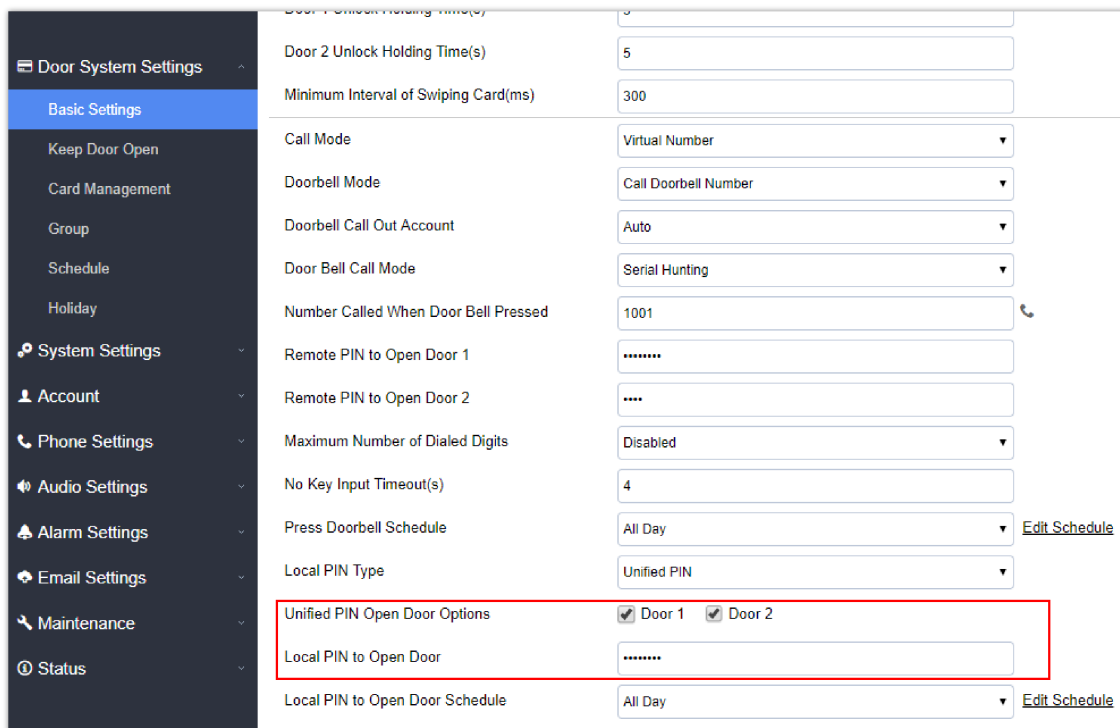

Universal Local PIN

If Unified PIN (Universal PIN) is configured to open door, then which door can be controlled by the PIN is configured in the UI once "Unified PIN" is selected.

For example, like the above screenshot, if this universal PIN is set to open both Door1 and Door2, but due to the previous "Control Option" set to open Door1, and "Wiegand Control" set to open Door2, therefore the final result will be the INTERSECT result of both sets with condition qualified.

- **Remote PIN to Operation of Doors:**

Note

The following configuration is exclusive to the GDS3705 Model.

For remote PIN to open door, the PIN can be configured in example down below.

The PIN can be different for Door1 and Door2 and has to be configured correctly in related IP Phone which will be used to operate "One Key Open Door".

If BOTH doors need to be opened at the same time, then both Door1 and Door2 have to be configured with the exactly SAME password or PIN as DTMF open door.

Note

For enhanced security, When call is initiated from GDS then only the numbers existing in "Number Called When Door Bell Pressed", "Account White Lists" or "Card Management" will be able to use DTMF PIN to open door remotely.

The screenshot shows the GDS3705 Door System Settings interface. The left sidebar contains a menu with categories: Door System Settings (Basic Settings, Keep Door Open, Card Management, Group, Schedule, Holiday), System Settings, Account, Phone Settings, Audio Settings, Alarm Settings, Email Settings, Maintenance, and Status. The main content area displays various settings for Door 1 and Door 2. Two fields are highlighted with red boxes: 'Remote PIN to Open Door 1' (masked with 7 dots) and 'Remote PIN to Open Door 2' (masked with 4 dots). At the bottom, the 'Enable DTMF Open Door' checkbox is checked and also highlighted with a red box. Other settings include Door 2 Unlock Holding Time (5s), Minimum Interval of Swiping Card (300ms), Call Mode (Virtual Number), Doorbell Mode (Call Doorbell Number), Doorbell Call Out Account (Auto), Door Bell Call Mode (Serial Hunting), Number Called When Door Bell Pressed, Maximum Number of Dialed Digits (Disabled), No Key Input Timeout (4s), Press Doorbell Schedule (All Day), Local PIN Type (Unified PIN), Unified PIN Open Door Options (Door 1 checked, Door 2 unchecked), Local PIN to Open Door, and Local PIN to Open Door Schedule (All Day).

Door 1 Unlock Holding Time(s)	5
Door 2 Unlock Holding Time(s)	5
Minimum Interval of Swiping Card(ms)	300
Call Mode	Virtual Number
Doorbell Mode	Call Doorbell Number
Doorbell Call Out Account	Auto
Door Bell Call Mode	Serial Hunting
Number Called When Door Bell Pressed	
Remote PIN to Open Door 1
Remote PIN to Open Door 2
Maximum Number of Dialed Digits	Disabled
No Key Input Timeout(s)	4
Press Doorbell Schedule	All Day Edit Schedule
Local PIN Type	Unified PIN
Unified PIN Open Door Options	<input checked="" type="checkbox"/> Door 1 <input type="checkbox"/> Door 2
Local PIN to Open Door	
Local PIN to Open Door Schedule	All Day Edit Schedule
Enable DTMF Open Door	<input checked="" type="checkbox"/>

Remote PIN to Open Door

o **Private PIN or Card & Private PIN:**

Note

The following configuration is exclusive to the GDS3705 Model.

← Add Card Info

Username*	John Snow
Private PIN	...
Gender	Male ▼
ID Number	123
Card Number*	89978456
Valid Start Date	1970-01-01
Valid End Date	2099-12-31
Virtual Number*	1
Sip Number	1001
Call Out Account	Auto ▼
Cellphone	561545020
Group	Disabled ▼
Schedule	Disabled ▼
Right of Card and Private PIN	<input checked="" type="checkbox"/> Door 1 <input checked="" type="checkbox"/> Door 2
Enable	<input checked="" type="checkbox"/>

Note: Open Door will not work by PIN if password is blank.

Right of Card and Private PIN

If using an RFID card or Private PIN to open door, then which door can be opened by the RFID card or Private PIN is configured via "Card Management", see above screenshot.

Note

For all the settings, the final result of which door can be opened is the **LOGIC INTERSECT OPERATION of ALL the sets of conditions** qualified.

Please refer to our Open Door Flow chart for better understanding of how to configure and control 2 Doors operation: http://firmware.grandstream.com/GDS3710_opendoors_logic.pdf

Keep Door Open

This feature allows users to set either an immediate or scheduled open door, this will allow usage scene like schools or similar private or public places where the door needs to keep open at specific time window and closed otherwise. Also handy for buildings or properties where a seminar needs to be hosted for some period or lunch breaks in a factory or company where the door keeps open and no access log required then back to locked with authorized entry after that, by default it's disabled.

- Door System Settings
- Basic Settings
- Keep Door Open
- Card Management
- Group
- Schedule
- Holiday
- System Settings
- Account
- Phone Settings
- Audio Settings
- Alarm Settings
- Email Settings
- Maintenance
- Status

Keep Door Open

Keep Door Open Disabled ▾

Emergency PIN to Disable Keep Door Open

Emergency PIN to Re-enable Keep Door Open

Keep Door Open

Keep Door Open	<p>Defines the keep open door mode that will be used, the options are:</p> <ol style="list-style-type: none"> Disabled: the door will not be kept open immediately or on a schedule. Immediate Open Door: the door will be opened immediately, with a timer. Schedule Open Door: the door will be opened on a schedule.
Emergency PIN to Disable Keep Door Open	A pin code used to disable Keep Door Open.
Emergency PIN to Re-enable Keep Door Open	After using "Emergency PIN to disable Keep Door open", this password can be used to re-enable the keep door open feature

Keep Door Open options

There are two modes under this section:

1. Immediate Open Door (One Time Only Action)

Keep Door Open

Keep Door Open Immediate Open Door ▾

Interval of Keep Door Open(min)

Immediate Door Open

Keep Door Open	Select the Keep Door Open mode.
Length(m) to Keep Door Open	<p>Set the amount of time in minutes where the door will keep opened. Click Save to open door immediately.</p> <p>Default value is 5.</p>

Immediate Door-Open Table

2. Schedule Open Door (Repeated Action)

Keep Door Open

Keep Door Open Schedule Open Door ▼

Schedule Start Time

Schedule End Time

Holiday Mode Disabled ▼ [Edit Holiday](#)

<input type="checkbox"/>	0	1	2	3	4	5	6	7	8	9	10	11	12	13	14	15	16	17	18	19	20	21	22	23	0
Sun																									
Mon																									
Tue																									
Wed																									
Thu																									
Fri																									
Sat																									
Holiday																									

Schedule Door Open

Keep Door Open	Select the Keep Door Open mode.
Schedule Start Time	Selects the start time when the door will be opened.
Schedule End Time	Selects the end time when the door will be locked.
Schedule	Selects the schedule on which the scheduled Keep Door Open will be applied.
Holiday Mode	Users can specify which Holiday Schedule to be included in the Keep Door Open schedule.

Schedule Keep Door Open

Click on Edit schedule to select which periods for each day the door will remain open, as shown below screenshot.

Modify Schedule ✕

Sun	Period1	12 ▼	:	00 ▼	-	14 ▼	:	00 ▼
Mon	Period2	00 ▼	:	00 ▼	-	00 ▼	:	00 ▼
Tue	Period3	00 ▼	:	00 ▼	-	00 ▼	:	00 ▼
Wed	Period4	00 ▼	:	00 ▼	-	00 ▼	:	00 ▼
Thu	Period5	00 ▼	:	00 ▼	-	00 ▼	:	00 ▼
Fri	Period6	00 ▼	:	00 ▼	-	00 ▼	:	00 ▼
Sat	Period7	00 ▼	:	00 ▼	-	00 ▼	:	00 ▼
	Period8	00 ▼	:	00 ▼	-	00 ▼	:	00 ▼

Copy Sun Mon Tue Wed Thu Fri Sat Select All

Modify Schedule

Card Management

Note

The Card Management settings can be configured only on the GDS3705 Model.



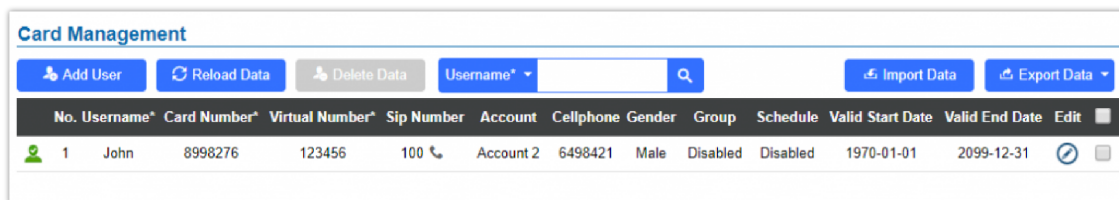

This page allows users to add information about RFID cards, two options are possible either add RFID cards manually or automatically.



The screenshot shows the 'Card Management' interface. At the top, there are buttons for 'Add User', 'Reload Data', 'Delete Data', a search bar for 'Username*', 'Import Data', and 'Export Data'. Below this is a table with columns: No., Username*, Card Number*, Virtual Number*, Sip Number, Account, Cellphone, Gender, Group, Schedule, Valid Start Date, Valid End Date, and Edit. A single row is visible with the following data: 1, John, 8998276, 123456, 100, Account 2, 6498421, Male, Disabled, Disabled, 1970-01-01, 2099-12-31, and an edit icon.

Card Management

Notes

- o The GDS3705 can add up to 2000 card users.
- o Press  or  to import / export users' configuration file, information, and data stored on the GDS3705.
- o Users can export and upload .CSV and .GS files:
- o ".gs" format is encrypted database file, it can NOT be edited and the password or PIN inside also can NOT be viewed.
- o ".csv" format is NOT encrypted therefore all the content is viewable and editable.
- o System Administrators should be VERY careful when exporting databases in such file format, as convenience is provided at the cost of security. It is STRONGLY suggested system administrator to set PASSWORD to SafeGuard the exported CSV format database file when edit or revise the file using Excel.
- o Use   to search for an entry on the Cards list.

Add Users Manually

To add users, click on  , the following page will pop up.

← Add Card Info

Username*	<input type="text" value="John Snow"/>
Private PIN	<input type="text" value="..."/>
Gender	<input type="text" value="Male"/>
ID Number	<input type="text" value="123"/>
Card Number*	<input type="text" value="89978456"/>
Valid Start Date	<input type="text" value="1970-01-01"/>
Valid End Date	<input type="text" value="2099-12-31"/>
Virtual Number*	<input type="text" value="1"/>
Sip Number	<input type="text" value="1001"/>
Call Out Account	<input type="text" value="Auto"/>
Cellphone	<input type="text" value="561545020"/>
Group	<input type="text" value="Disabled"/>
Schedule	<input type="text" value="Disabled"/>
Right of Card and Private PIN	<input checked="" type="checkbox"/> Door 1 <input checked="" type="checkbox"/> Door 2
Enable	<input checked="" type="checkbox"/>

Note: Open Door will not work by PIN if password is blank.

Card Info

Username	Configures the username to identify the user.
Private PIN	Specifies a PIN to unlock the door for this particular user.
Gender	Selects a gender, either Male or Female.
ID Number	Enters an ID number (This number is set by the admin to identify each user uniquely).
Card Number	Enters the RFID Card number (this is the number written on the RFID card. When "card issuing mode" is enabled, this field will be added automatically).
Valid Start Date	Configures the start date of validity of the RFID card.
Valid End Date	Configures the End date of validity of the RFID card.
Virtual Number	When dialing directly from the keypad, the GDS accepts only Virtual number to identify a user, once the Virtual number is typed followed by the # key, the SIP Number will be dialed.
SIP Number	Configures the SIP Number which is mapped with a virtual number. Once the virtual number is dialed the GDS3705 will send an INVITE to the SIP Number. Note: The SIP Number can be configured with an extension/phone number or IP address. Example: 192.168.5.124
Call Out Account	Select the SIP account that will be used to call the SIP Number extension, when choosing Auto, the unit will use the first available SIP account.
Cellphone	Configures the cellphone of the user.
Group	Specifies to which group the user will be added.
Schedule	Specifies the schedule that will be assigned to the user.
Right of Card and Private PIN	Select the doors that can be accessed by the user.
Enable	When checked, the user's RFID and Private PIN will be active for door opening. If unchecked, the Private PIN nor RFID card swipe won't take effect.

Card Info







Note

- Group overrides Schedule.
- If Schedule is set as "Disabled" the RFID Card will be accepted when swiped.

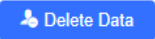
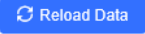
Add Users Automatically

If [Enable Card Issuing Mode] is checked, the GDS3705 keypad will start blinking and once an RFID card is swiped, data stored on the card will be added to the GDS3705 card management page, user can still edit the entry added automatically by modifying some fields.



Users Operation

- Click on  to edit the entry or show details of the entry.
- Select the entries and click on  to delete the selected users.
- Click  to refresh the data entered to the GDS3705.
- Users can use Go to:      to navigate through User Management pages.

Group

Note

The following configuration is exclusive to the GDS3705 Model.



The Group page permits to manage the groups which will contains multiple users, click on  to create new groups or  to edit existing groups or  to delete the group.

Note: Users can create up to 50 groups.

Add Group ✕

Group Name

Schedule ▼







 

Add Group

Group Name	Configures the name to identify the group.
Schedule	Specifies the schedule that will be used by the group.

Table 9: Add Group



The following screenshots display the list of the created groups.

Group				
				
No.	Group Name	Schedule	Edit	Delete
1	Support	schedule1		
2	Sales	schedule2		
3	Documentation	schedule3		

Groups List





















Schedule

The Schedule page allows to manage schedule time frames which will be assigned to the users for door system usage. Out of the configured time intervals, GDS3705 will not allow users to access.

Click on  to edit a schedule or  for schedule details.

Note



The GDS3705 supports up to 10 schedules.

No.	Schedule Name	Holiday Name	Detail	Edit
1	schedule1	Disabled		
2	schedule2	Disabled		
3	schedule3	Disabled		
4	schedule4	Disabled		
5	schedule5	Disabled		
6	schedule6	Disabled		
7	schedule7	Disabled		
8	schedule8	Disabled		
9	schedule9	Disabled		
10	schedule10	Disabled		



Edit Schedule Time

Holiday

The Holiday page allows to manage holidays which will be assigned to the users for door system usage.

Click on  to edit the holidays or  for holiday details.

Schedule Name

Duration1 -  

« Sep 2017 »

Sun	Mon	Tue	Wed	Thu	Fri	Sat
27	28	29	30	31	1	2
3	4	5	6	7	8	9
10	11	12	13	14	15	16
17	18	19	20	21	22	23
24	25	26	27	28	29	30
1	2	3	4	5	6	7

Today OK

Edit Holiday Time

System Settings

This page allows users to configure date and time, network settings as well as access method to the GDS370x and password for accessing the Web GUI.

Date & Time Settings

This page allows users to adjust the system date and time of the GDS370x.

The screenshot shows the 'Date & Time' configuration page for a GDS3705 device. The left sidebar contains navigation options like 'Door System Settings', 'System Settings', 'Date & Time', 'Network Settings', etc. The main content area includes the following settings:

- System Time:** 2024-06-10 14:29:43 (with a 'Sync PC' button)
- Allow DHCP Option 42 to Override NTP Server:**
- Allow DHCP Option 2 to Override Time Zone Setting:**
- Time Zone:** GMT (Dublin, Lisbon, London, Reykjavik)
- Enable Daylight Saving Time:**
- Start Time:** Jan, First, Sunday, 00:00
- End Time:** Jan, First, Sunday, 00:00
- Enable NTP:**
- NTP Server:** pool.ntp.org
- Update Interval (m):** 1440

Date & Time Page

System Time	Displays the current system time.
Allow DHCP Option 42 to override NTP server	Defines whether DHCP Option 42 should override NTP server or not. When enabled, DHCP Option 42 will override the NTP server if it's set up on the LAN. The default setting is "Yes".
Allow DHCP Option 2 to Override Time Zone Setting	Allows the device to get provisioned for Time Zone from DHCP option 2 in the local server.
Time Zone	Selects from drop down menu the preferred time zone.
Enable Daylight Saving Time	Enables Daylight Saving Time.
Start time	Selects the Start time of DST.
End Time	Selects DST end time.
Enable NTP	Enables NTP to synchronize device time.
NTP Server	Configures the domain name of NTP server.
Update Interval	Configures the Interval (in minutes) to retrieve updates from the NTP server.

Date and Time Settings

Network Settings

This page allows users to set either a static or DHCP IP address to access the GDS370x.

- Door System Settings
- System Settings
 - Date & Time
 - Network Settings
 - OpenVPN® Settings
 - TR-069
 - Access Settings
 - User Management
 - Factory Functions
- Account
- Phone Settings
- Audio Settings
- Alarm Settings
- Email Settings
- Maintenance
- Status

Basic Settings

IP Address Config

IP Address Mode DHCP Static IP

IP Address

Subnet Mask

Gateway

DNS Config

DNS Address Type Dynamic DNS Static DNS

DNS Server 1

DNS Server 2

Advanced Settings

802.1X Mode

802.1X Identity

MD5 Password

802.1X CA Certificate

802.1X Client Certificate

Enable LLDP

Enable LLDP Disable Enable

Layer 2 QoS Settings

Enable VLAN Disable Enable

Network Settings Page

IP Address Mode	Selects DHCP or Static IP. Default DHCP. (Static recommended)
IP Address	Configures the Static IP of the GDS370x.
Subnet Mask	Configures the Associated Subnet Mask.
Gateway	Configures the Gateway IP address.
DNS Address Type	Specifies the DNS type used: Dynamic DNS or Static DNS.
DNS Server 1	Configures DNS Server 1 IP address.
DNS Server 2	Configures DNS Server 2 IP address.
802.1X Mode	Defines the 802.1X authentication mode, the supported options are: Disabled, EAP-MD5, EAP-TLS, EAP-PEAPv0/MSCHAPv2
802.1X Identity	Defines the identity for the 802.1X authentication
MD5 Password	Defines the password for the 802.1X authentication
802.1X CA Certificate	Uploads the CA certificate for the EAP-PEAPv0/MSCHAPv2 or EAP-TLS authentication mode, the supported file is .pem
802.1X Client Certificate	Uploads the client certificate for the EAP-TLS authentication mode, with the certificate and private key in .pem file

Enable LLDP	Controls the LLDP (Link Layer Discovery Protocol) service. The default setting is “Enabled”.
Enable VLAN	Enable/Disable VLAN assignement on GDS370x
Layer 2 QoS 802.1Q/VLAN Tag	Assigns the VLAN Tag of the Layer 2 QoS packets. Default value is 0.
Layer 2 QoS 802.1p Priority Value	Assigns the priority value of the Layer2 QoS packets. Default value is 0.

Network Settings

Notes

- If the GDS370x is behind SOHO (Small Office Home Office) router with port forwarding configured for remote access, static IP should be used to avoid IP address changes after router reboot.
- TCP port above 5000 is suggested to Port forward HTTP for remote access, due to some ISP would block port 80 for inbound traffic. For example, change the default HTTP port from 80 to 8088, to make sure the TCP port will not be blocked.

OpenVPN® Settings

This page allows users to configure OpenVPN settings.

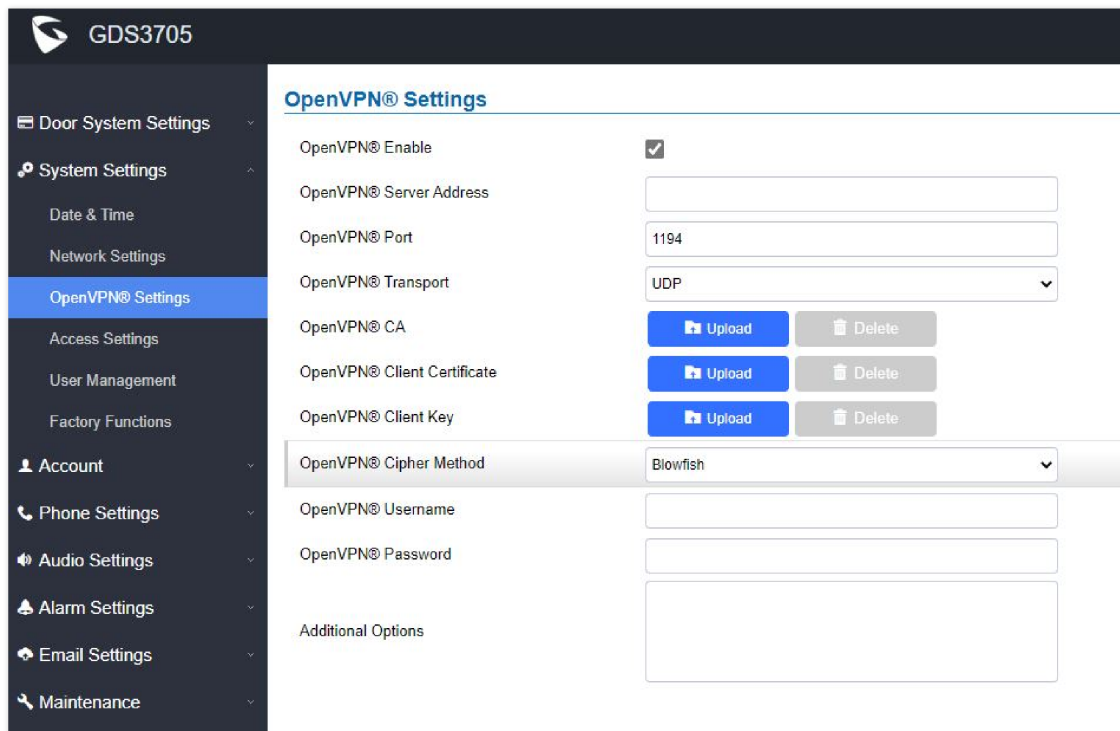

OpenVPN Settings page

Enable OpenVPN®	Enables/disables OpenVPN® functionality and requires the user to have access to an OpenVPN® server. Note: To use OpenVPN® functionalities, users must enable OpenVPN® and configure all of the settings related to OpenVPN®, including server address, port, OpenVPN® CA, certificate and key. Additionally, the user must also set the SIP account to use “VPN” for the “NAT Traversal” (under Account → Network Settings).
OpenVPN® Server Address	Defines the URL/IP address for the OpenVPN® server.

OpenVPN® Port	Defines the network port for the OpenVPN® server. The default setting is 1194 .
OpenVPN® Transport	Determines network protocol used for OpenVPN® (UDP or TCP). The default setting is TCP .
OpenVPN® CA	OpenVPN® CA file (ca.crt) required by the OpenVPN® server for authentication purposes. Press "Upload" to upload the corresponding file to the device.
OpenVPN® Client Certificate	OpenVPN® CA file (ca.crt) required by the OpenVPN® server for authentication purposes. Press "Upload" to upload the corresponding file to the device.
OpenVPN® Client Key	OpenVPN® Client key (*.key) required by OpenVPN® server for authentication purposes. Press "Upload" to upload the corresponding file to the device.
OpenVPN® Cipher Method	The cipher method of OpenVPN®, must be the same cipher method used by the OpenVPN® server. Supported methods are: Blowfish, AES-128, AES-256 and Triple-DES.
OpenVPN® Username	Configures the OpenVPN® authentication username (optional).
OpenVPN® Password	Configures the OpenVPN® authentication password (optional).

TR-069

This page configures the GDS370x TR-069/GDMS parameters.

TR069

Enable TR-069	<input type="checkbox"/>
ACS URL	<input type="text" value="https://acs.gdms.cloud"/>
ACS User Name	<input type="text"/>
ACS Password	<input type="password"/>
Periodic Inform Enable	<input checked="" type="checkbox"/>
Periodic Inform Interval (s)	<input type="text" value="60"/>
Connection Request User Name	<input type="text"/>
Connection Request Password	<input type="password"/>
Connection Request Port	<input type="text" value="7547"/>
CPE Cert File	<input type="text"/>
CPE Cert Key	<input type="text"/>

TR-069 Settings Page

Enable TR-069	Enables/disables TR-069
ACS URL	Specifies URL of TR-069 ACS (e.g.,http://acs.mycompany.com), or IP address. Default setting is "https://acs.gdms.cloud"
ACS User Name	ACS username for TR-069.
ACS Password	ACS password for TR-069.
Periodic Inform Enable	Enables periodic inform. If set to "Yes", device will send inform packets to the ACS. The valid range is 1 – 4294967295. The default setting is "Yes".
Periodic Inform Interval (s)	Sets up the periodic inform interval to send the inform packets to the ACS. The default value is "60".
Connection Request User Name	The username for the ACS to connect to the phone.
Connection Request Password	The password for the ACS to connect to the phone.
Connection Request Port	Configures the port of the ACS to connect to the phone, The Default port is 7547.
Connection Request Port	The port for the ACS to connect to the phone. The default value is "7547".
CPE Cert File	The Cert File for the phone to connect to the ACS via SSL.
CPE Cert Key	The Cert Key for the phone to connect to the ACS via SSL.

TR-069 Settings

Access Setting

This page configures the GDS370x access control parameters.

- Door System Settings
- System Settings
 - Date & Time
 - Network Settings
 - OpenVPN® Settings
 - TR-069
 - Access Settings
 - User Management
 - Factory Functions
- Account
- Phone Settings
- Audio Settings
- Alarm Settings
- Email Settings
- Maintenance
- Status

Access Settings

Web Access Mode	<input type="text" value="HTTPS"/>
Web Access Port	<input type="text" value="443"/>
User Login Timeout (m)	<input type="text" value="5"/>
Maximum Number of Login Attempts	<input type="text" value="5"/>
Login Lockout Duration (m)	<input type="text" value="5"/>
Disable Web Access	<input type="checkbox"/>
Enable UPnP Discovery	<input checked="" type="checkbox"/>
Enable PIN/Password Display (HTTPS)	<input type="checkbox"/>
Enable SSH	<input checked="" type="checkbox"/>
SSH Port	<input type="text" value="22"/>
Minimum TLS Version	<input type="text" value="TLS 1.1"/>
Maximum TLS Version	<input type="text" value="Unlimited"/>
GDSManager Configuration Password	<input type="password" value="*****"/>

Access Settings Page

Web Access Mode	Selects the access mode to the webGUI either HTTP or HTTPS.
Web Access Port	Specifies the TCP port for Web Access, default 443.
User Login Timeout(min)	If no action is made within this time the GDS371x will logout from the Web GUI, range is between 3 and 60.
Maximum Number of Login Attempts	Specifies the allowed login times error limit, if the unsuccessful login attempts exceed this value, the GDS370x webGUI will be locked for the time specified in Login Error Lock Time.
Login Lockout Duration (m)	Specifies how long the GDS370x is locked before a new login attempt is allowed.
Disable Web Access	<p>Allow or deny the web access to the GDS370x. (HTTP API do not take effect when this option is enabled).</p> <p>Note: If both WebUI and SSH are disabled, GDS370x will get blocked and not be able to be accessed. Only two ways to get it back:</p> <ol style="list-style-type: none"> 1. Re-provisioned by ITSP or Service Provider (by adjusting the related parameters) 2. Hard Reset (GDS371x has to be offline and uninstalled to perform this hard reset).
Enable UPnP Discovery	UPnP (or mDNS) function for local discovery. Default setting is enabled.
Enable SSH	Allows SSH access for remote secured configuration purposes (restart, upgrade, provision...)
SSH Port	<p>Specifies the SSH port.</p> <p>Default setting is 22.</p>
Minimum TLS Version	<p>Configures the minimum TLS version supported by the device.</p> <p>Minimum TLS version must be less than or equal to maximum TLS version.</p> <p>The Available options are : TLS 1.0, TLS 1.1, TLS 1.2</p> <p>The default value is TLS 1.1</p> <p>Note: SNI "Server Name indication" is supported on TLS, it allows a client to specify the hostname it is trying to connect to at the start of the TLS handshake, meaning that GDS370x system can now handle secure connections for multiple domains on a single IP.</p>
Maximum TLS Version	<p>Configures the maximum TLS version supported by the device.</p> <p>Maximum TLS version must be greater than or equal to minimum TLS version.</p>

	The Available options are : TLS 1.0, TLS 1.1, TLS 1.2, unlimited. The default value is unlimited.
GDSManager Configuration Password	User can set in this field a custom admin password instead of using GDS370x webUI administrator's credentials, and this custom admin password will be the one used when adding the GDS370x unit to GDSManager database. Default password is the Admin's default random password of the GDS370x.

Phone Settings

User Management

This page allows users to configure the password for the administrator. Since this is a door system which must be a secure product, the use is only limited to administrator.

User Management

Password Recovery Email is not configured. Please input Password Recovery Email address and configure a valid SMTP service in Email Settings Page

Change Password

Old Password	<input type="text"/>
New Password	<input type="text"/>
Confirm New Password	<input type="text"/>

Change Recover Email

Password Recover Email Address	<input type="text"/>	Email Settings
--------------------------------	----------------------	--------------------------------

User Management Page

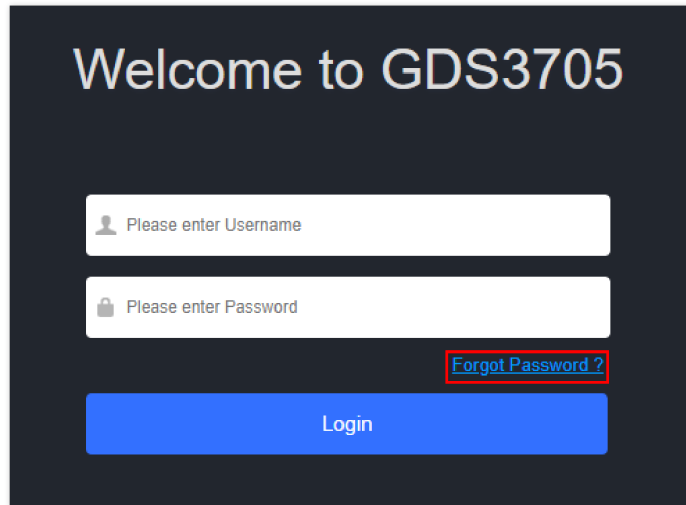

Recover Password

Old Password	Old password must be entered to change new password.
New Password	Fill in the revised new password in this field.
Confirm User Password	Re-enter the new password for verification, must match.
Password Recovery Email Address	If the password is lost, you can recover it on the configured Email address here. Note: Make sure to configure SMTP Email Settings under " Email Settings ".

User Management

To recover lost password, users can from the login page click on Forgot Password?

Click the link will pop up the following page to ask to input the "Email Address" for the Recover Password to be sent to:

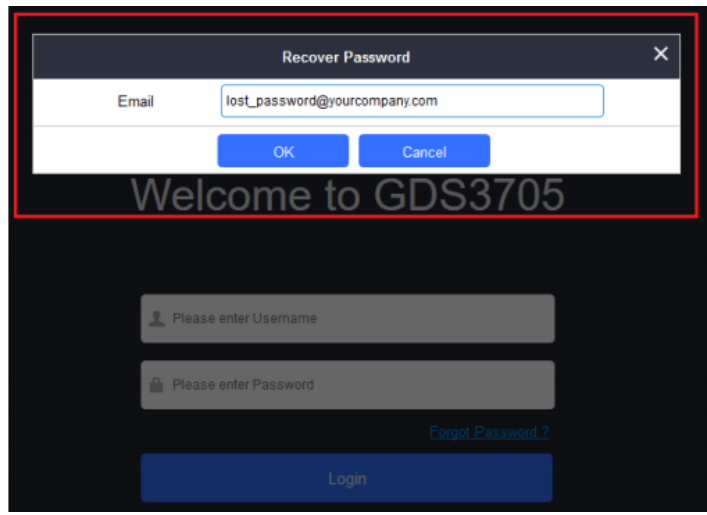

Recover Password – Email Address

If the "Password Recover Email Address" and related SMTP is configured correctly, then click the "OK" button, the device will email the administrator password to the inputted email address, if the email address entered matches the pre-configured "Password Recover Email Address" inside the device and the device with working SMTP service configured.

Otherwise the device will prompt the following message at top of the UI page to advise user to configure the related parameters or service, to make this feature working. User can still click "Cancel" to omit these setting and continue the UI operation, but this is bad operation behavior.

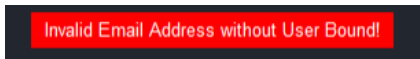

Grandstream strongly suggest user to configure a working email address as "Password Recover Email Address" and configure a good SMTP service to the device. So, if something happened, the administrator can get the password recover email to unlock the device.

Factory Functions

Users could access factory functions in order to diagnosis the hardware and software of the unit like verifying the audio loopback and certificates verification.

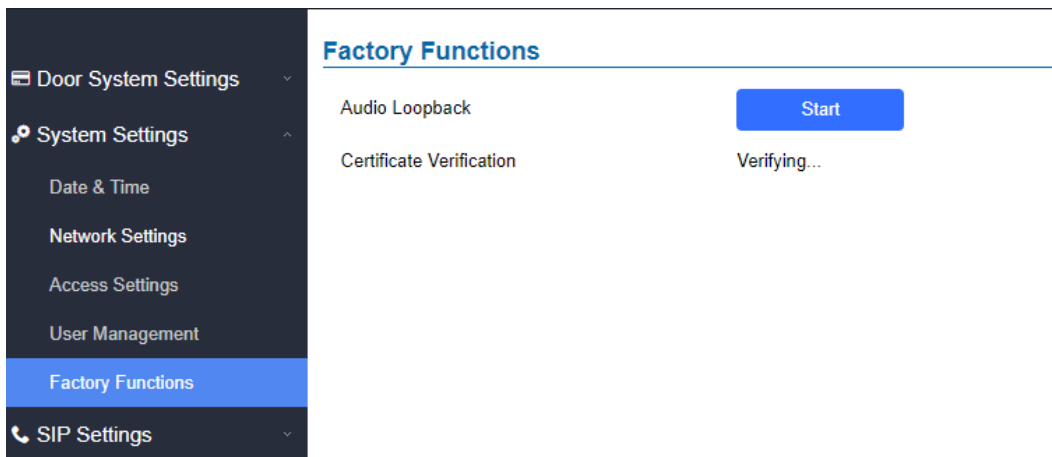

Factory Function Page

Audio Loopback	Press Start button and speak to the GDS370x. If you can hear your voice, your audio is working fine. Press Stop to exit audio loopback mode.
Certificate Verification	This is used to validate certificate chain for the server's certificate.

Account

The GDS370x supports 4 SIP accounts and 4 lines, this section covers the configuration of basic and advanced SIP settings for each SIP account.

Account 1 – 4

This page allows the administrator to configure the SIP account basic and advanced settings for each SIP account:

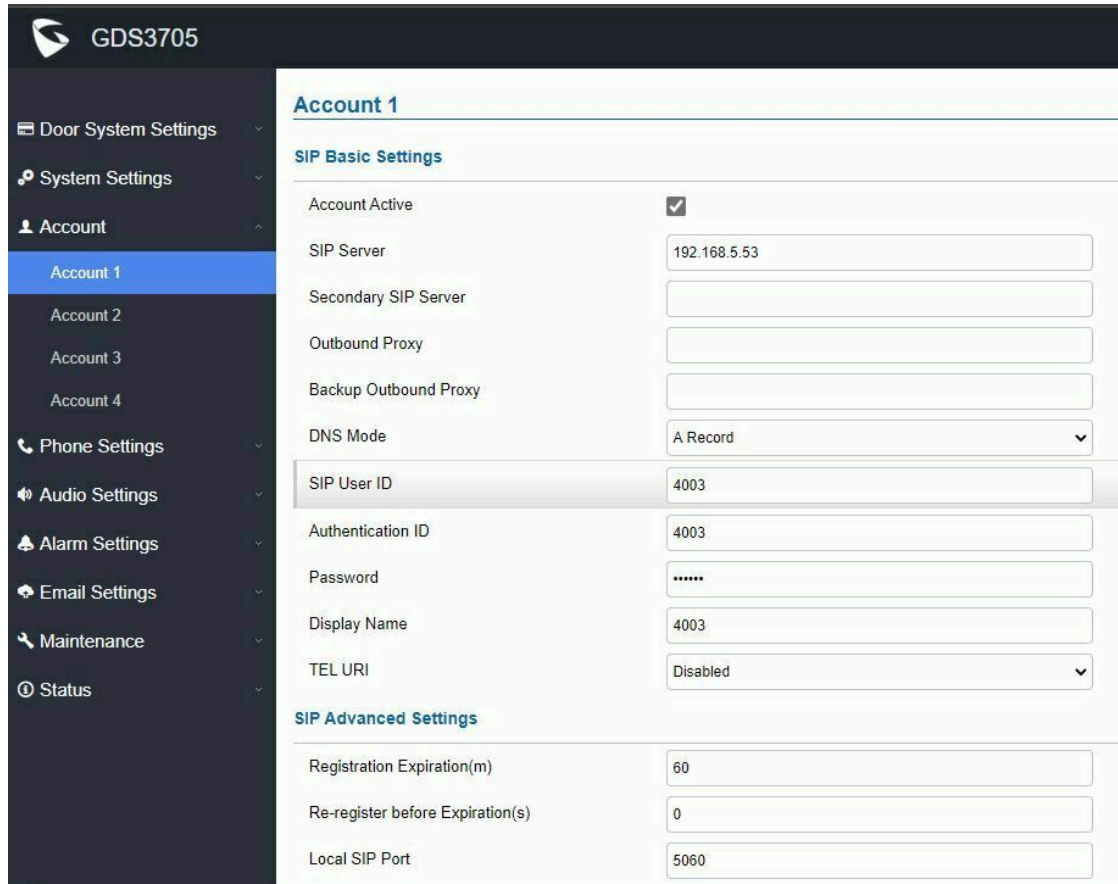

SIP Account Settings Page

SIP Basic Settings	
Account Active	This field indicates whether the account is active. Default setting is “Yes”.
SIP Server	Configures the FQDN or IP of the SIP server from VoIP service provider or local IPPBX.
Secondary SIP Server	Configures the FQDN or IP of the Secondary SIP server from VoIP service provider or local IPPBX.
Outbound Proxy	Configures the IP address or the domain name of the outbound proxy, media gateway, or session border controller. It's used by the GDS for firewall or NAT penetration in different network environments. If a symmetric NAT is detected, STUN will not work and only an outbound proxy can provide a solution.
Backup Outbound Proxy	Configures the backup outbound proxy to be used when the “Outbound Proxy” registration fails. By default, this field is left empty.
DNS Mode	Configure which DNS mode will be used to translate the SIP Server FQDN (Default value is A Record): <ul style="list-style-type: none"> • A Record • SRV

	<ul style="list-style-type: none"> ● NAPTR/SRV <p>Note: Service providers can use DNS SRV feature to provide smooth service transition backup in case service down.</p>
SIP User ID	<p>Configures the SIP username or telephone number from ITSP.</p> <p>Note: Letters, digits and special characters including @ are supported.</p>
Authentication ID	<p>Configures the Authenticate ID used by SIP proxy.</p>
Password	<p>Sets the Authenticate password used by SIP proxy.</p> <p>Note: For security reasons, the SIP password is invisible on the web UI.</p>
Display Name	<p>The GDS370x is an audio only device, unlike GDS371x, user cannot see who is in at the door. Adding this "Display Name" will also allow user receiving calls from GDS370x knowing where the call is coming from (e.g.: which door or extension the call is made), improve user experience when user is using a IP phone with LCD display.</p>
Tel URI	<p>Select "User=Phone" or "Enabled" from the dropdown list.</p> <p>If the SIP account has an assigned PSTN telephone number, this field should be set to "User=Phone". Then a "User=Phone" parameter will be attached to the Request-Line and "TO" header in the SIP request to indicate the E.164 number. If set to "Enable", "Tel:" will be used instead of "SIP:" in the SIP request. The default setting is "Disable".</p>
SIP Advanced Settings	
Registration Expiration (m)	<p>Sets the registration expiration time.</p> <p>Default setting is 60 minutes. Valid range is from 1 to 64800 minutes.</p>
Re-register before Expiration (s)	<p>Specifies the time frequency (in seconds) that the GDS370x sends re-registration request before the Register Expiration. The default value is 0. Range is from 0 to 64800 seconds.</p>
Local SIP Port	<p>Sets the local SIP port. Default setting is 5060 for Account 1, 5062 for Account 2, 5064 for Account 3, 5066 for Account 4.</p>
SIP Transport	<p>Chooses the SIP transport protocol. Default settings is UDP.</p>
Enable DTMF	<p>Specifies the mechanism to transmit DTMF digits. There are 2 supported modes:</p> <ul style="list-style-type: none"> ● RFC2833 sends DTMF with RTP packet. Users can check the RTP packet to see the DTMFs sent as well as the number pressed. ● SIP INFO uses SIP INFO to carry DTMF. Default setting is "RFC2833"
DTMF Payload Type	<p>Configures the payload type for DTMF using RFC2833.</p> <p>Default value is 101. Range: 96~127.</p>
Enable Keep Alive	<p>Checks to help NAT resolution, sending alive packets.</p>
Unregister On Reboot	<p>Allows the SIP user's registration information to be cleared when the GDS370x reboots. The SIP REGISTER message will contain "Expires: 0" to unbind the connection.</p>
NAT Traversal	<p>This parameter configures whether the NAT traversal mechanism is activated. Users could select the mechanism from No, STUN, Keep-alive, UPnP, Auto or VPN. The default setting is "No".</p> <p>If set to "STUN" and STUN server is configured, the GDS370x will route according to the STUN server. If NAT type is Full Cone, Restricted Cone or Port-Restricted Cone, the unit will try to use public IP addresses and port number in all the SIP&SDP messages.</p> <p>The GDS will send empty SDP packet to the SIP server periodically to keep the NAT port open if it is configured to be "Keep-alive". Configure this to be "No" if an outbound proxy is used. "STUN" cannot be used if the detected NAT is</p>

	symmetric NAT. Set this to “VPN” if OpenVPN is used.
Enable SRTP	Enable SRTP mode based on your selection from the drop-down menu. The default setting is “Disabled”, the two other modes are “Enabled but Not Forced” and “Enabled and Forced”.
Special Feature	Configures GDS settings to meet different vendors’ server requirements. Users can choose from Standard, Broadsoft or Telefonica Spain. The default setting is “Standard”.
Outbound Proxy Mode	In route: outbound proxy FQDN is placed in route header. This is used for the SIP Extension to notify the SIP server that the device is behind a NAT/Firewall. Always sent to: SIP messages will always be sent to Outbound proxy. Not in route: remove the Route header from SIP requests.
Validate Incoming Messages	Specifies if the device will check the incoming SIP messages caller ID and CSeq headers. If the message does not include the headers, it will be rejected. The default setting is “No”.
Enable RTCP	This option allows 3rd party Service Provider or Cloud Solution to monitor the operation status of the GDS370x by using related SIP Calls. By default, it’s disabled. Users can choose either RTCP or RTCP-XR.
Accept Incoming SIP from Proxy Only	When set to “Yes”, the SIP address of the Request URL in the incoming SIP message will be checked. If it doesn’t match the SIP server address of the account, the call will be rejected. The default setting is “No”
SIP URI Scheme When Using TLS	This option allows the GDS370x to work with Cisco WebEX server as SIP client. The two modes are SIP and SIPS.
Support SIP Instance ID	When enabled, the GDS370x will work with Cisco WebEX server as SIP client.
Custom SIP Headers	
Use P-Access-Network-Info Header	Enables/disables the use of P-Access-Network-Info header in SIP request. When disabled, the SIP message sent from the phone will not include the selected header. Default setting is “Yes”.
Add MAC in User-Agent	If Yes except REGISTER , the SIP message for register or unregister will contains MAC address in the header, and all the outgoing SIP messages except REGISTER message will attach the MAC address to the User-Agent header; If Yes to ALL SIP , the sip message for register or unregister will contains MAC address in the header, and all the outgoing SIP message including REGISTER will attach the MAC address to the User-Agent header; If No , neither will the MAC header be included in the register or unregister message nor the MAC address be attached to the User-Agent header for any outgoing SIP message. The default setting is “No”.
Vocoder Settings	
Preferred Vocoder 1	Selects the Highest Preferred audio codec. Supported codecs are: PCMU, PCMA, G.722 and G.729A/B.
Preferred Vocoder 2	Selects the Second Highest Preferred audio codec. Supported codecs are: PCMU, PCMA, G.722 and G.729A/B.
Preferred Vocoder 3	Selects the Third Highest Preferred audio codec. Supported codecs are: PCMU, PCMA, G.722 and G.729A/B.

Preferred Vocoder 4	Selects the Last Preferred audio codec. Supported codecs are: PCMU, PCMA, G.722 and G.729A/B.
Voice Frame per TX	Configures the number of voice frames transmitted per packet. When configuring this, it should be noted that the “ptime” value for the SDP will change with different configurations here. This value is related to the codec used and the actual frames transmitted during the in-payload call. For end users, it is recommended to use the default setting, as incorrect settings may influence the audio quality. The default setting is 2. Range is from 1-64.

SIP Account Basic & Advanced Settings

Phone Settings

The phone settings allow users to configure the GDS370x phone settings and the White list for all the SIP accounts.

Phone Settings

This page allows users to configure the GDS370x phone settings.

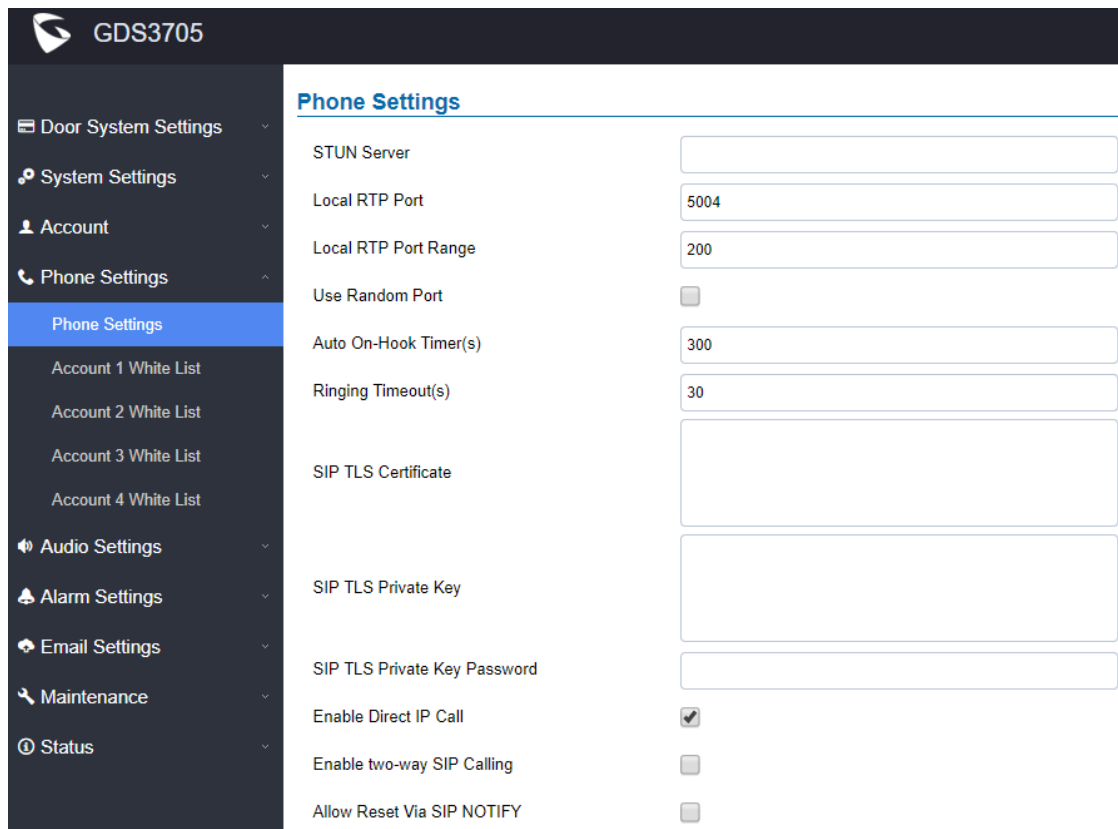

Phone Settings Page

STUN Server	Configures the STUN server FQDN or IP. If the device is behind a non-symmetric router, STUN server can help to penetrate & resolve NAT issues.
Local RTP Port	Sets the local RTP port for media. Default setting is 5004.
Local RTP Port Range	Define the range of local RTP port from 48 to 10000
Use Random Port	Forces the GDS3705 to use random ports for both SIP and RTP messages. This is usually necessary when multiple units are behind the same full cone NAT. The default setting is “Disabled” Note: This parameter must be set to “Disabled” for Direct IP Calling to work.

Auto On-Hook Timer	Configures the auto on-hook timer (in seconds) for automatic disconnecting the SIP call. Default setting is 300.
Ring Timeout(s)	Specifies the Ring timeout, when no reply is returned from the called party after exceeding this field, the GDS3705 will hang up the call. The value is in the range of 0s – 90s. By default; it is “30” seconds.
DNS Cache Expiration Time(m)	Configures the DNS Cache expiration Time, the default value is 30 , the range is 1-1440
DNS Cache Duration(m)	Configures the DNS Cache expiration Duration, the default value is 30 , the range is 1-1440
SIP TLS Certificate	Copy/Paste the TLS certificate here for encryption.
SIP TLS Private Key	Input private key here for TLS security protection.
SIP TLS Private Key Password	Specifies the password for SIP TLS private Key.
Enable Direct IP Call	Accepts peer-to-peer IP call (over UDP only) without SIP server. Default is “Enabled”.
Enable two-way SIP Calling	Allows the user to enable/disable the alarm sound during a SIP call triggered by doorbell pressing.
Allow Reset Via SIP NOTIFY	Allows to factory reset the devices directly through SIP Notify. If “Allow Reset Via SIP NOTIFY” is “check”, then once the GDS3705 receives the SIP NOTIFY from the SIP server with Event: reset, the GDS3705 will perform a factory reset after authentication. This authentication can be either with: The admin password if no SIP account is configured on the GDS370x. The SIP User ID and Password credentials of the SIP account if configured on the GDS370x. Default is unchecked (disabled).

Phone settings

Account [1-4] White List

This page allows users to configure the white list per account, which is a phone number or extension list that can call the GDS370x. (The call will be automatically answered when calling from a phone set on the white list, and all other inbound calls will be blocked), the user can configure up to 30 white phone numbers per SIP account.

Moreover, besides numbers associated to active cards, and numbers on the “Number Called When Door Bell Pressed” setting, all whitelisted numbers can open door remotely by using the respective PIN code (Can be configured for the GDS3705 Model only)

White List Page

The table below gives a brief overview of the options:

Enable White Number List	Enables the White List feature.
Phone Number 1 -200	Adds a new phone number to the white list.

White List

Audio Settings

The audio settings allow users to configure the audio codecs and Volume related settings.

Audio Settings

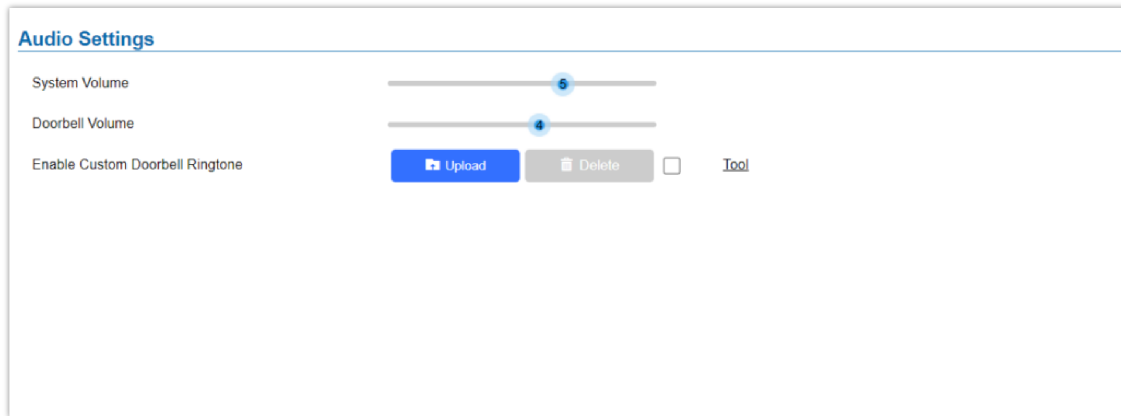

This page allows users to configure the audio settings.



Audio Settings Page

System Volume	Adjusts the speaker volume connected.
Doorbell Volume	Adjusts the doorbell volume.
Enable Custom Doorbell Ringtone	User can check this option in order to use the custom Doorbell Ringtone. Default Ringtone is used when this option is disabled.
Tool	This button will redirect user to our Grandstream Ringtone Generator tool in our website.

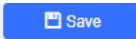
Audio Settings Page

- Click on  to upload the ringtone file, then press .
- Click on  to delete the existent custom ringtone.
- Support upload WAV, PCM audio file (size <= 600K). Format limit to:

WAV:

1. Sample Rate: 8k or 16k.
2. Channel: Mono-channel or Dual-channel.

PCM:

1. Sample Rate: 8K.
2. Channel: Dual-channel.

Note

Empty audio file is not accepted.

Alarm Config

This page allows users to configure alarm schedule and alarm actions.

Alarm Events Config

This page allows users to configure GDS370x events to trigger programmed actions within predefined schedule.

Alarm Events Config

Digit Input

Digit Input 1: Disable

Digit Input 2: Disable

Digit Output

Alarm Output Duration (s): 5

Turn Off Alarm Output After Hang up Alarm Call:

Alarm Config

Enable Silent Alarm Mode:

Enable Hostage Code:

Enable Tamper Alarm:

Enable Alarm for PIN Input Error:

Select Alarm Action Profile: profile 1 [Edit Profile](#)

Enable Non-scheduled Access Alarm:

Enable Unauthorized RFID Card Access Alarm:

Enable SIP Calling Trigger Alarm Output:

[Save](#)

Events Page

Digit Input 1	<p>Selects the Input method (alarm Input or Door Open). Default disabled.</p> <p>Digital Input Port operates in 3 Modes:</p> <ol style="list-style-type: none">1. Alarm Input: Connect various of sensor to trigger alarm.2. Open door: Connect a switch to open door from inside.3. Abnormal Door Control: When enabled (special wiring required, see below wiring diagram), abnormal open door will be detected and therefore trigger siren alarm. <p>Notes:</p> <p>If Digital Input port is connected to a switch, it will not work during the time of power outage, device booting or firmware upgrading.</p> <p>Abnormal open door will be detected by DI port (Alarm_In2 or IN2 in below diagram showed) if wired correctly (connecting the COMx port to DIx port). Please refer to XXX for diagrams showing the correct wiring to enable this feature.</p>
Digit Input 1 Status	<p>If set to Normal Open: Configured alarm will be triggered when Digital Input Status switch from Close to Open.</p> <p>If set to Normal Close: Configured alarm will be triggered when Digital Input Status switch from Open to Close.</p> <p>By default, Input Digit 1 Status is "Disabled".</p>
Select Schedule 1	Selects the predefined Alarm Schedule.
Select Alarm Action Profile 1	Selects the predefined Alarm Action for Profile 1.

Digit Input 2	<p>Selects the Input method (alarm Input or Door Open). Default disabled.</p> <p>Digital Input Port operates in 2 Modes:</p> <ol style="list-style-type: none"> 1. Alarm Input: Connect various of sensor to trigger alarm. 2. Open door: Connect a switch to open door from inside. <p>If Digital Input port is connected to a switch, it will not work during the time of power outage, device booting or firmware upgrading.</p>
Digit Input 2 Status	<p>If set to Normal Open: Configured alarm will be triggered when Digital Input Status switch from Close to Open.</p> <p>If set to Normal Close: Configured alarm will be triggered when Digital Input Status switch from Open to Close.</p> <p>By default, Input Digit 2 Status is "Disabled".</p>
Select Schedule 2	Selects the predefined Alarm Schedule.
Select Alarm Action Profile 2	Selects the predefined Alarm Action for Profile 2.
Alarm Output Duration(s)	<p>Select the duration of the alarm output: Always/1/2/3/4/5/10/15/20/25/30/60/300/900 seconds.</p> <p>When "Always" is selected, the triggered alarm will not go off until the alarm is off."</p> <p>This option is visible when ALMOUT1 Feature is set to Alarm Out</p>
Turn Off Alarm Output After Hang up Alarm Call	<p>This option refers to disabling the alarm signal once an active alarm call is ended, configured to ensure the alarm output stops after a specified duration if the call is terminated or the DTMF sequence matched.</p> <p>Disabled by default.</p>
Enable Silent Alarm Mode	<p>Enable/Disable silent alarm mode.</p> <p>If Silently Alarm Mode is enabled, GDS370x will disable alarm sound and background light for specified alarms types (Digital Input) when they are triggered.</p> <p>Note: This option affects only alarm sound/light, other actions will still be applied.</p> <p>Disabled by Default</p>
Silent Alarm Options	<p>When the silently alarm mode is enabled, users can specify to which alarm options the silently mode will be applied to. The available options are: Digital Input, Tamper Alarm, and Password Error.</p>
Enable Hostage Code	<p>Enable/Disable the Hostage password mode.</p> <p>Hostage password can be used in a critical situation for instance a kidnaping or an emergency, users need to enter the following sequence to trigger the actions set for the Hostage Mode: "*" HostagePassword #".</p>
Hostage Code	<p>Configures the password for the hostage mode.</p> <p>Note: This configuration is exclusive to the GDS3705 Model.</p>
Select Alarm Action Profile	<p>Select the Alarm action to be taken when the hostage password is typed on the GDS3705 keypad.</p> <p>Note: No sound alarm will be triggered in this mode.</p>
Enable Tamper Alarm	<p>When activating this mode, GDS370x will keep alarming until the alarm is dismissed.</p> <p>Tamper alarm is anti-hack from Hardware level. When this option is checked, if the GDS370x is removed from the installation bracket, the built-in Howell Magnetic Switch will function and Tamper Alarm (if enabled and configured, default disabled) will be fired.</p> <p>This embedded feature in the GDS37xx serves the purpose of enabling the device to detect the separation of these two components, similar to how security magnetic sensors detect the opening and closing of windows or doors.</p>

Select alarm Action Profile	Select the type of alarms actions to be triggered for the tamper alarm mode.
Enable Alarm for PIN Input Error	Enable/Disable the Input Error Alarm, GDS3705 will trigger alarm actions at every 5 incorrect attempts. Note: This configuration is exclusive for the GDS3705 Model
Select Alarm Profile	Select the type of alarms actions to be triggered after 5 incorrect attempts.
Enable Alarm for PIN Input Error	When enabled, After 5 consecutive incorrect pin codes, the device plays an alarm siren sound and takes alarm actions.
Select Alarm Action Profile	Select the type of alarms actions to be triggered.
Enable Non-scheduled Access Alarm	If enabled, an alarm will be triggered if a user with scheduled access attempts to access outside of the designated schedule. Disabled by default.
Select Alarm Action Profile	Select the type of alarms actions to be triggered.
Enable Unauthorized RFID Card Access Alarm	Unauthorized RFID Card Access Alarm will be triggered when an unauthorized RFID card /fob is swiped on the GDS3705.
Enable SIP Calling Trigger Alarm Output	Allows the GDS370x to initiate a SIP call to designated contacts whenever a specific alarm condition is met, for the option to work, the alarm action of the profile needs to include the option "Audio Alarm to SIP Phone", this will allow to trigger a call to the phone number defined on "Number x called when doorbell pressed", if many numbers are configured, the call will be triggered on serial manner, or parallel manner depending on your setting.

Alarm Schedule Settings

This page specifies the configuration of Alarm Schedule.

Note: Schedule must be configured first to allow the alarm to take the related action.

Alarm Schedule Settings

No.	Schedule Name	Detail	Edit
1	schedule1		
2	schedule2		
3	schedule3		
4	schedule4		
5	schedule5		
6	schedule6		
7	schedule7		
8	schedule8		
9	schedule9		
10	schedule10		

Alarm Schedule

GDS370x supports up to 10 alarm schedules to be configured, with time span specified by users. User can edit the alarm schedule by clicking button. Usually the 24 hours' span is 00:00 ~ 23:59, which is 24 hours' format.

Users can copy the configuration to different date during the schedule programming.

Modify Schedule
✕

Schedule Name

Sun	Period1	00	:	00	-	23	:	59
Mon	Period2	00	:	00	-	00	:	00
Tue	Period3	00	:	00	-	00	:	00
Wed	Period4	00	:	00	-	00	:	00
Thu	Period5	00	:	00	-	00	:	00
Fri	Period6	00	:	00	-	00	:	00
Sat	Period7	00	:	00	-	00	:	00
	Period8	00	:	00	-	00	:	00

Copy Sun Mon Tue Wed Thu Fri Sat Select All

Save
Cancel

Edit Schedule

Alarm Action Settings

This page specifies the configuration of Profile used by the Alarm Actions. A Profile is required before the Alarm Action can take effect.

Alarm Action Settings					
No.	Alarm Action Profile Name	Detail	Edit	Test	
1	profile1	<div style="border: 1px solid #ccc; padding: 5px; background-color: #f9f9f9;"> <div style="display: flex; justify-content: space-between;"> <div style="width: 45%;"> <p><input checked="" type="checkbox"/> Upload to Alarm Center</p> <p><input checked="" type="checkbox"/> Audio Alarm to SIP Phone</p> <p><input checked="" type="checkbox"/> Send Email</p> </div> <div style="width: 45%;"> <p><input checked="" type="checkbox"/> Audio Alarm</p> <p><input checked="" type="checkbox"/> Alarm Output</p> </div> </div> </div>	⌵	⌵	
2	profile2		⌵	⌵	
3	profile3		⌵	⌵	
4	profile4		⌵	⌵	
5	profile5		⌵	⌵	
6	profile6		⌵	⌵	
7	profile7		⌵	⌵	
8	profile8		⌵	⌵	
9	profile9		⌵	⌵	
10	profile10		⌵	⌵	

Alarm Action

User can edit the alarm action by clicking ⌵ button, the following window will popup.

Modify Alarm Action Profile
✕

Alarm Action Profile Name

Upload to Alarm Center

Audio Alarm to SIP Phone

Send Email

Audio Alarm

Alarm Output

Save
Cancel

Edit Alarm Action

To test an alarm action profile, users can click on  button and the GDS will initiate all actions specified on the select alarm profile.

Upload to Alarm Center	If selected, the GDSManager will popup alarm window and sound alarm in the computer speaker.
Audio Alarm to SIP Phone	If selected, GDS370x will call pre-configured phone and will play sound alarm. When an alarm is triggered (e.g., unauthorized door access), the system can automatically initiate a normal call to a designated phone number (e.g., security personnel), notifying them of the event.
Send Email	If selected, an email will be sent to the pre-configured email destination.
Audio Alarm	If selected, GDS370x will play alarm audio using built-in speaker.
Alarm Output	If selected, the alarm will be sent to the equipment (for example: Siren) connected to Alarm Output interface.

Alarm Actions

Alarm Phone

This page allows users to configure the Alarm Phone List, which are phone numbers or extensions list that the GDS370x will call out when event is triggered (e.g.: doorbell pressed), the administrator can configure up to 20 phone numbers to be called and specify the SIP account to trigger the alarm call.

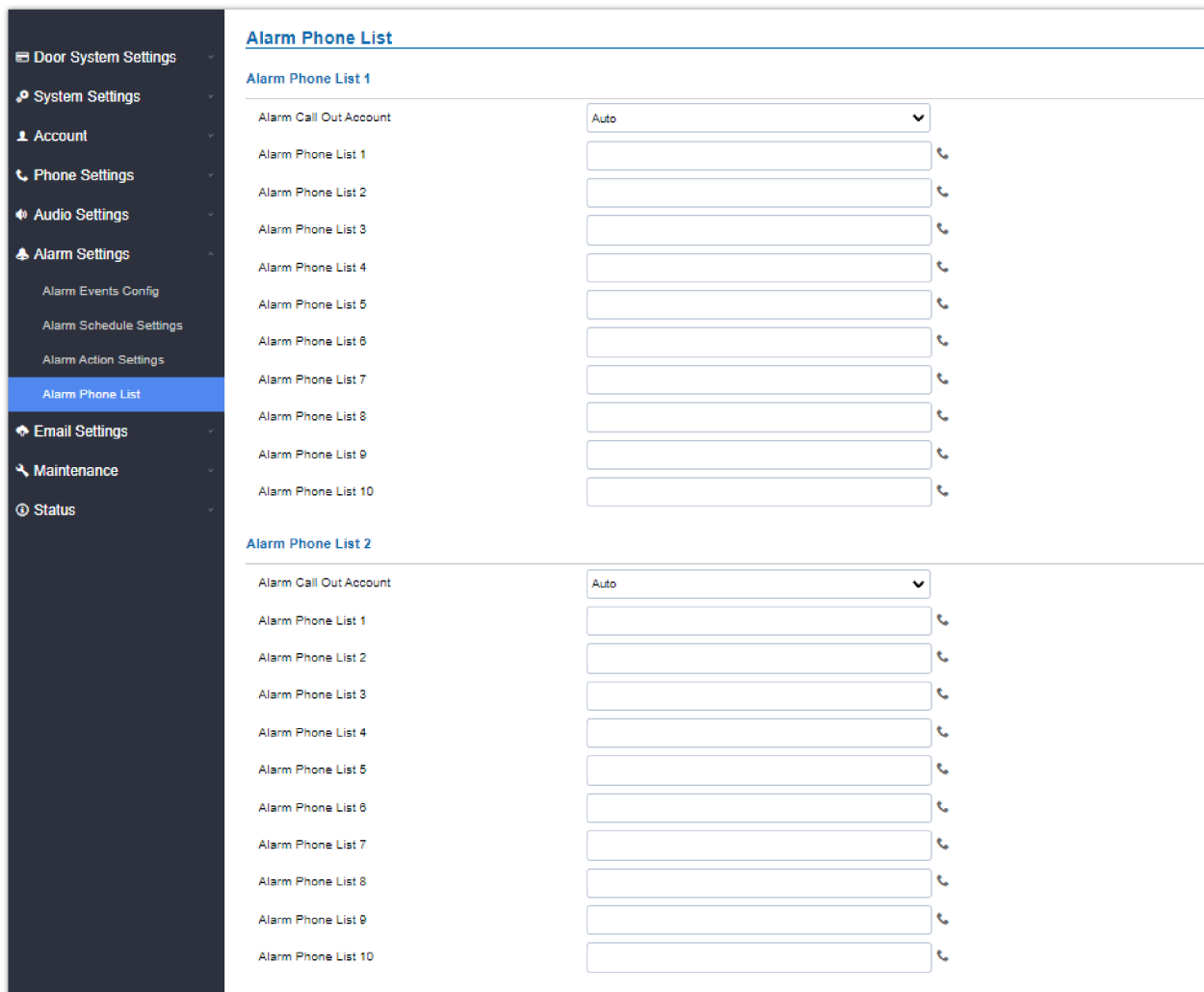

Alarm Phone List

Alarm Phone List 1

Alarm Call Out Account: Auto

Alarm Phone List 1

Alarm Phone List 2

Alarm Phone List 3

Alarm Phone List 4

Alarm Phone List 5

Alarm Phone List 6

Alarm Phone List 7

Alarm Phone List 8

Alarm Phone List 9

Alarm Phone List 10

Alarm Phone List 2

Alarm Call Out Account: Auto

Alarm Phone List 1

Alarm Phone List 2

Alarm Phone List 3

Alarm Phone List 4

Alarm Phone List 5

Alarm Phone List 6

Alarm Phone List 7

Alarm Phone List 8

Alarm Phone List 9

Alarm Phone List 10

Alarm Phone List

Alarm Phone List 1 / Alarm Phone List 2	
Alarm Call Out Account	Define the SIP account that will be used to trigger the alarm call, when choosing Auto, the unit will use the first available SIP account.
Alarm Phone 1-10	Add the phone numbers to be called into the alarm list.

Alarm Phone List

Once the event is triggered (Door Bell Pressed...), the GDS370x will call the first number, once time out is reached and no answer is returned from the first number, the GDS370x will try the next number on the list and so on. Once the remote phone answers the call, an alarm will be played to notify users that an event is triggered.

Email Settings

This page contains Email Settings.

Email Settings

This page allows users to configure email client to send out an email when the alarm is triggered.

Email Settings – SMTP Page

SMTP Server	Configures the SMTP Email Server IP or Domain Name.
SMTP Server Port	Specifies the Port number used by server to send email.
From E-mail address	Specifies the email address of alarm email sending from, usually client email ID.
Sender Email ID	Specifies sender's User ID or account ID in the email system used.
Sender Email Password	Specifies sender's password of the email account.
Alarm-To Email Address 1	Specifies the 1st email address to receive the alarm email.
Alarm-To Email Address 2	Specifies the 2nd email address to receive the alarm email.
SSL	Check if the SMTP email server requires SSL.

Email Subject	Customize your own warning email subject. The default subject will be used if the field is left empty. Default is empty.
Email Content	Customize your own warning email content, the default will be used if field left empty. Note: “event type”, “username” and “card ID” are sent in the email event for open door.

Notes

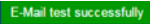
- Click “Save” to save the email configuration information.
- Click “Email Test” after configuration, if settings are correct, a test email will send out and “E-mail test successfully” message on the top page will appear  .

Maintenance Settings

This page shows the GDS370x Maintenance parameters.

Upgrade

This page contains the upgrade parameters of the GDS370x.

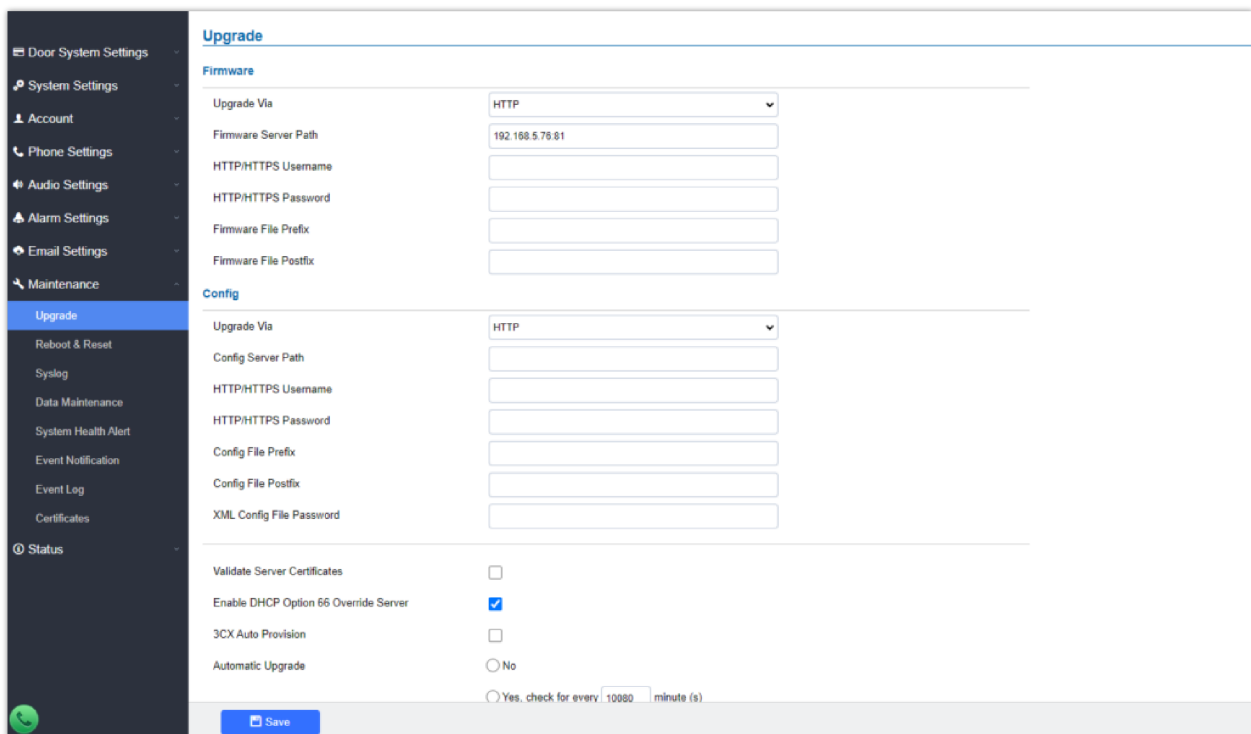

Upgrade Page

Upgrade Via	Selects the upgrade method (HTTP, HTTPS).
Firmware Server Path	Configures the IP address or the FQDN of the upgrade server.
Config Server Path	Configures the IP address or the FQDN of the configuration server.
HTTP/HTTPS User Name	User name if needed by remote provisioning HTTP/HTTPS server.
HTTP/HTTPS Password	Password to authenticate with remote provisioning HTTP/HTTPS server.

Firmware File Prefix	Prefix that will be added when requesting firmware file.
Firmware File Postfix	Postfix that will be added when requesting firmware file.
Config File Prefix	Defines the Prefix that will be added when requesting config file.
Config File Postfix	Postfix that will be added when requesting config file.
XML Config File Password	Specifies the password for the configuration file. Note: Do not input the password in this field if the .xml config file in the server is not encrypted
Validate Server Certificate	Enable this option to validate certificate with trusted ones during TLS connection.
Automatic Upgrade Interval(m)	Specifies the upgrade interval in minutes.
Enable DHCP Option 66 Override Server	Activates DHCP option 66 to override upgrade/config servers.
3CX Auto Provision	If the option is enabled, the GDS370x will multicast a SIP SUBSCRIBE message for retrieving configuration files, if any is available, it will be retrieved by a SIP NOTIFY reply message. This option is disabled by default
Automatic Upgrade	Enables automatic upgrade and provisioning. Set schedule for provisioning for either every X minutes, every day or every week. Default is No.
Randomized Automatic Upgrade	Enable and define the start/End hours of the day and days of the week where the GDS will randomly checking for update.
Disable SIP NOTIFY Authentication	If this option is checked, the Device will not challenge NOTIFY with 401. Default setting is Enabled.

Reboot & Reset

This page allows user to reboot (scheduled or immediate) and reset the GDS370x.

Reboot & Reset

Reboot [Reboot](#)

Auto Reboot Everyday 00 : 00

Reset Retain Network Data Only [Reset](#)

Reboot	When clicked, the GDS370x will restart (soft reboot).
Auto Reboot	With this feature, users can configure convenient selected schedule for the device to reboot by itself, per week or per day.
Reset	There are two options for the reset function.
Clear All Data	All data will be reset, GDS370x will be set to factory default.
Retain Network Data Only	All data will be erased except for Network data like IP address...

Retain Only Card Information	All data will be erased except for cards information.
Retain Network Data and Card Information	All data will be erased except for Network Data and Card Information.

Reset & Reboot

Syslog

This page allows user to configure SYSLOG to collect information to help troubleshooting issues with GDS370x.

Syslog Page

Syslog Protocol	The communication protocol used for sending log messages, UDP, or SSL/TLS. Default is UDP
Syslog Server	The server IP address or FQDN where log messages are sent and stored.
Syslog Level	The severity or priority level of log messages to be recorded (e.g., error, warning, info).

Syslog Page Settings

Note

- Five levels of Debugging are available, None, Debug, Info, Warning, Error.
- Once the Syslog Server and the level entered, press "Save" and then Reboot the GDS370x to apply the settings.

Data Maintenance

This page allows users to manage the GDS370x configuration file by importing/exporting the configuration files.

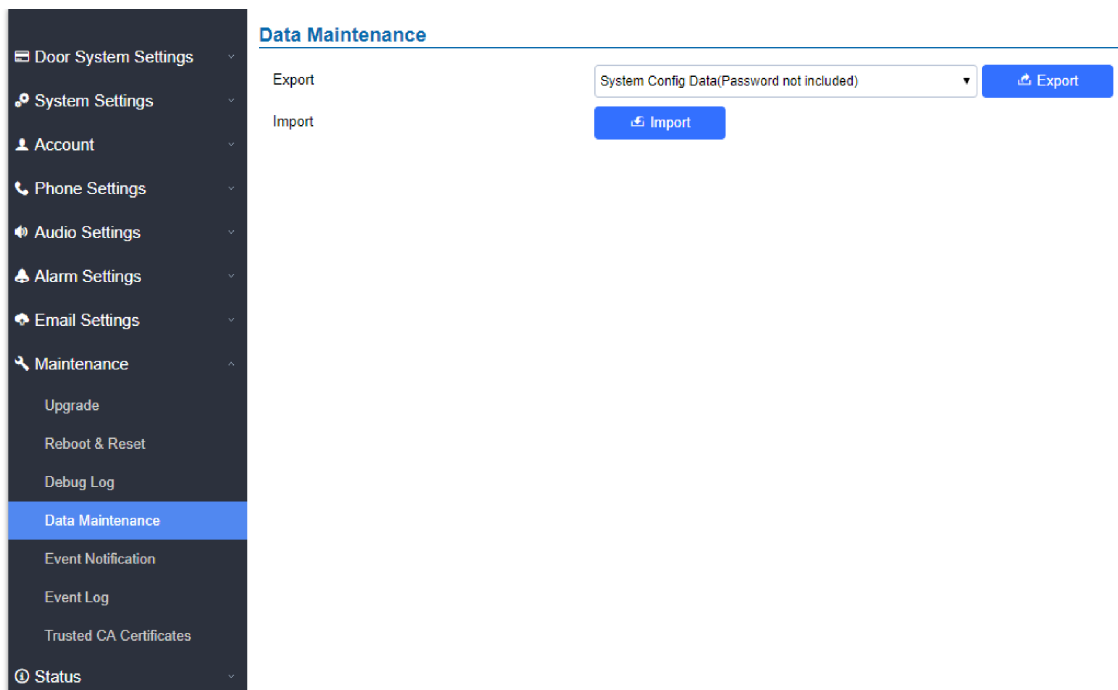

Data Maintenance Page

Click on  to save the GDS370x configuration in a predefined directory.

Note

Users can either select to include all the passwords (SIP, Remotes access...) on the configuration files exported or not including the passwords as displayed on the previous figure.

System Health Alert

This page allows users to enable real-time or periodic email notifications about the GDS system status: Registration, Running Status and Temperature. This will require **Email Settings** already configured.

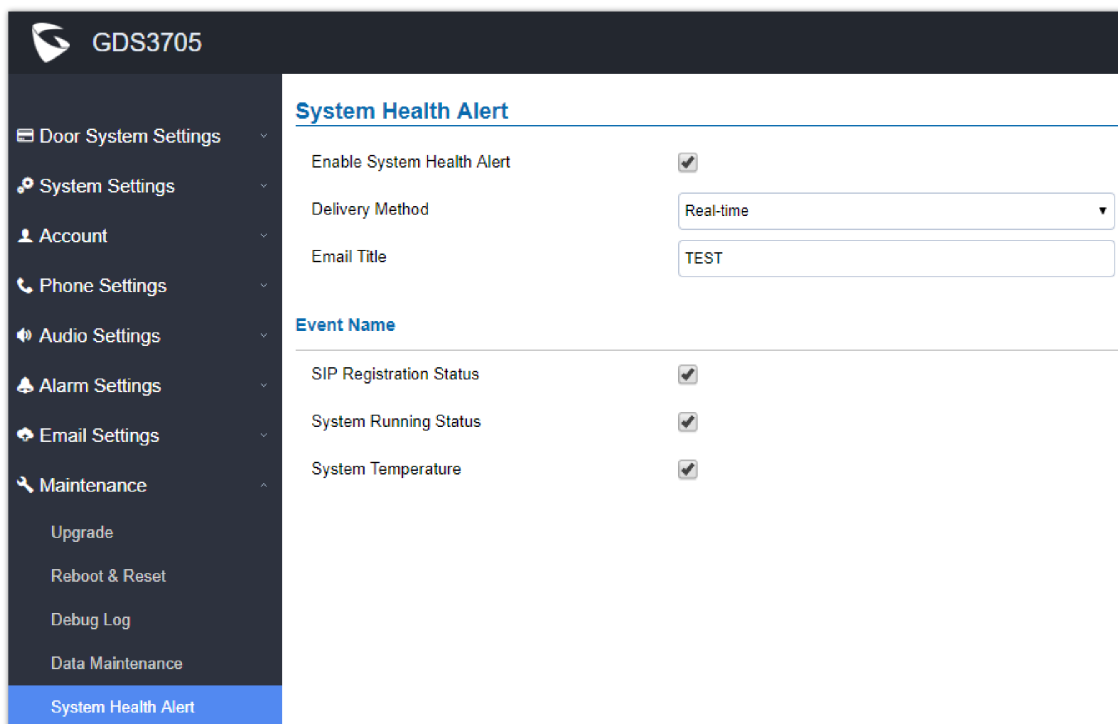

System Health Alert Page

Enable System Health Alert	When this option is checked, then the GDS will send alert emails regarding the events selected under Event Name section using the already configured [Email Settings].
Delivery Method	There are two options: <ul style="list-style-type: none"> Real-Time: the GDS will be sending successively alert emails every second. Periodic: a Time Interval of 1~10080 minutes between each email can be configured.
Email Title	This would be the Email Subject title. Maximum characters number is 256.
Event Name	SIP Registration Status: When checked, Email will contain Offline/Online indication for all 4 accounts.
System Running Status: When checked, Email will contain the system uptime.	
System Temperature: When checked, Email will contain Temperature value of the system in °C and °F, as well as whether the temperature is normal or not.	

System Health Alert

Event Notification

This page allows users to configure the event notification details that will be used by GDS370x to communicate to an HTTP server and Log Events. When the feature Enable and Configured, all the event logs will be uploaded to server: RFID open door (for GDS3705 only), PIN open door (for GDS3705 only), SIP Call, Alarm, etc...

For instance, the GDS3705, after an RFID Card swiping, will send to the configured HTTP server the following HTTP POST containing "Use card open door" event:

```
POST / HTTP/1.1

Host: 192.168.6.107
Authorization: Basic Og==
Connection: keep-alive
Content-Length: 90

Date: 2017-11-09; Time: 14:07:27; Event describe: Use card open door. Card ID: 378690700.
```

Or, the GDS3702, after making a Call, when doorbell pressed, will send to the configured HTTP server the following HTTP POST containing "Phone call" event:

```
POST/HTTP/1.1

Host:192.168.6.107
Authorization:BasicOg==
Connection:keep-alive
Content-Length:62

Date: 2017-11-09; Time: 14:13:12; Event describe: Phone call.
```

These HTTP POST messages can be used by a 3rd party software to integrate the GDS370x.

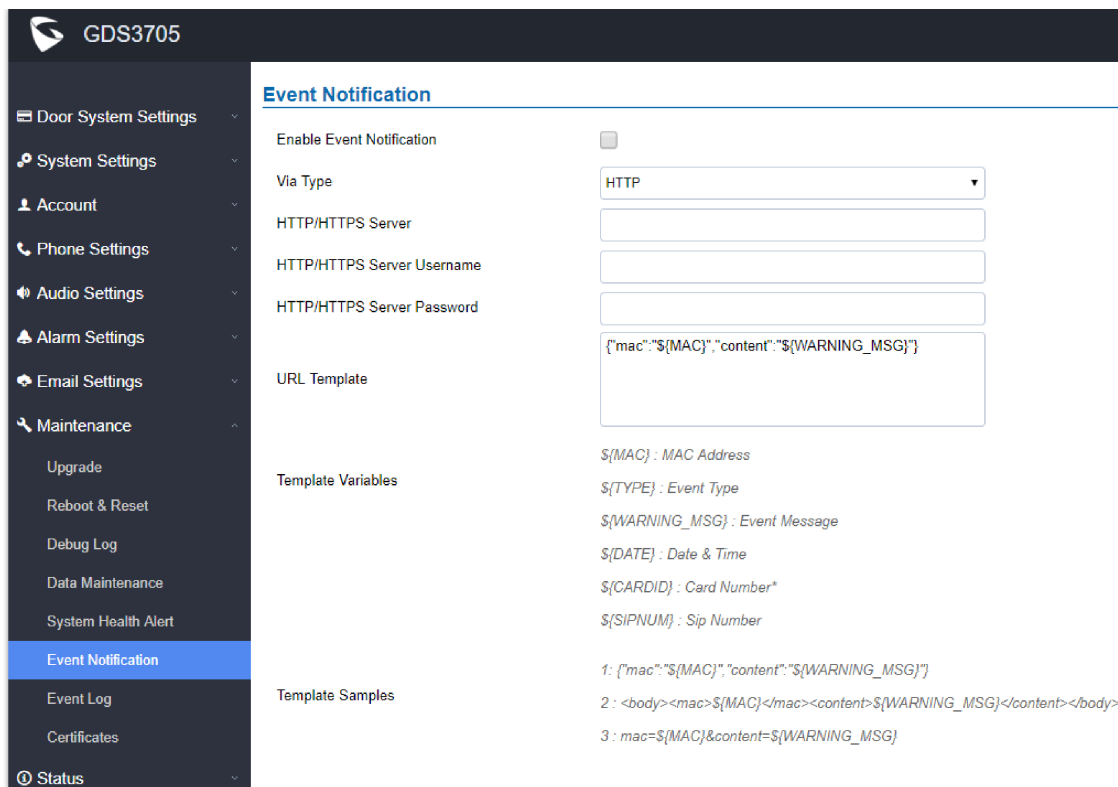

Event Notification

Event Log

Users could check all device logs directly from the GDS web UI under the menu “**Maintenance → Event log**”.

To get logs for a specific date interface, select the Start Time and End Time, then select which Event type you want to check using the drop-down list, and click on [Search](#) to display the records.

The following Event Types are included for filtering:

OpenDoor (via card, Pin or DI, Card+PIN, remote PIN.).

- Open Door via Card
- Visiting Log
- Open Door via PIN
- Open Door via DI
- Call Log
- Open Door via Card and PIN
- Open Door via Remote PIN
- DI Alarm
- Door & Lock Abnormal Alarm
- Dismantle by Force
- System Up
- Reboot
- Reset
- Config Update
- Firmware Update
- Non-scheduled Access
- Hostage Alarm
- Invalid Password

- Temperature Alarm
- Unauthorized door opening attempt
- Admin Login

No.	Date & Time	Event Type	Username	Card Number	(Account)Sip Number
1	2018-12-26 15:37:37	System Up			
2	2018-12-26 16:03:28	Open Door via Private PIN	user		

Event Log

For more information about event logs, please visit this [guide](#).

Notes

- The maximum size of log storage space of GDS370x is about 3M.
- The size of each event log is 48 bytes.
- If the log data exceeded the maximum storage space, then the oldest log will be automatically released which will be 128K of old data.

Certificates

This page allows users to upload up to 6 Trusted CA certificate files which will be trusted by the GDS during SSL exchange.

Also users are allowed to configure the device with custom certificate signed by custom CA certificate under the Custom Certificate section.

DigiCert certificates are supported.

Trusted CA Certificates		
No.	Issued By	Expiration
1		
2		
3		
4		
5		
6		

Custom Certificate		
No.	Issued By	Expiration
1		

Upload Certificate files

In order to upload your Trusted CA certificate:

Click on **Upload** button to upload a file and some related information to the uploaded file will be displayed, such as **“Issued by”** and **“Expiration date”**.

Trusted CA Certificates		
No.	Issued By	Expiration
1	-	2018-07-17 15:46:03
2	-	-

User could press  to delete one of the files.

In order to upload your Custom certificate:

Click on  button to upload a file and some related information to the uploaded file will be displayed, such as “**Issued by**” and “**Expiration date**”.



The screenshot shows a table titled "Custom Certificate" with three columns: "No.", "Issued By", and "Expiration". There is one row with the number "1" in the "No." column. To the right of the table are two buttons: "Upload" and "Delete".

No.	Issued By	Expiration
1		

User could press  to delete one of the files.

Status

This page displays GDS370x accounts, system, and network information.

Account Status

This page displays of configured accounts' SIP user ID, SIP server as well as the SIP Registration status, from Account 1 to Account 4.

Notes:

- When the SIP account is registered, the SIP Registration status display will be Online
- When SIP account is unregistered, the SIP Registration status display will be Offline

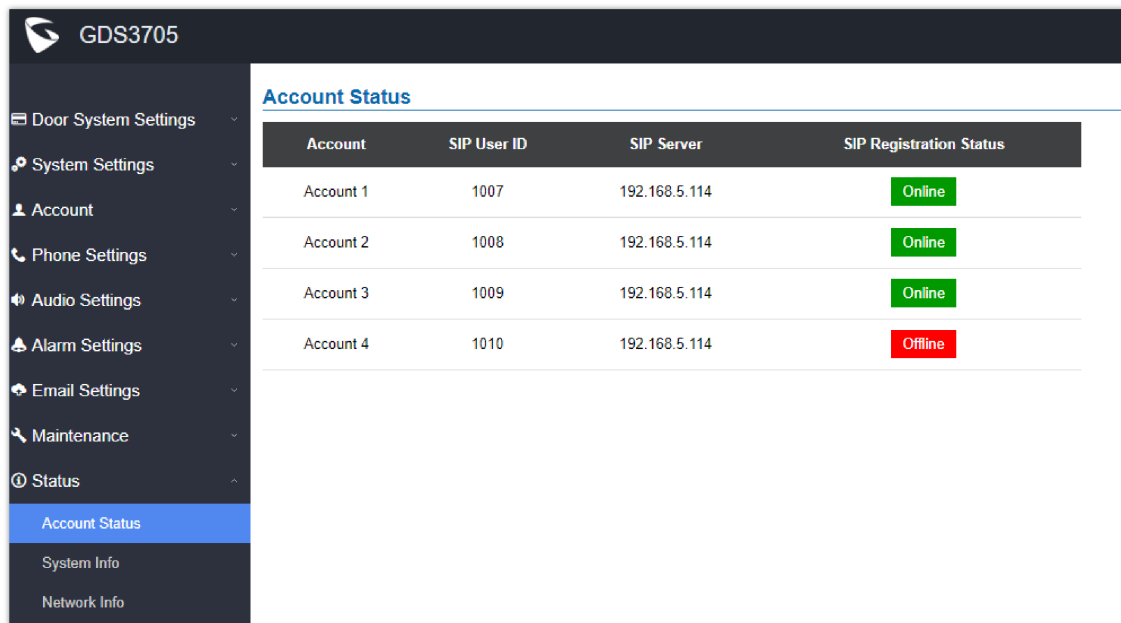

The screenshot shows the "Account Status" page in the GDS3705 interface. It features a sidebar menu on the left with options like "Door System Settings", "System Settings", "Account", "Phone Settings", "Audio Settings", "Alarm Settings", "Email Settings", "Maintenance", and "Status". The "Account Status" option is selected. The main content area displays a table with the following data:

Account	SIP User ID	SIP Server	SIP Registration Status
Account 1	1007	192.168.5.114	Online
Account 2	1008	192.168.5.114	Online
Account 3	1009	192.168.5.114	Online
Account 4	1010	192.168.5.114	Offline

System Info

This page displays information such as the product model, the hardware version, firmware...

- Door System Settings
- System Settings
- Account
- Phone Settings
- Audio Settings
- Alarm Settings
- Email Settings
- Maintenance
- Status
 - Account Status
 - System Info
 - Network Info

System Info

Product Model	GDS3705
Hardware Version	V1.0A
Part Number	9630001610A
Boot Version	1.0.3.16
Core Version	1.0.3.16
Base Version	1.0.3.16
Prog Version	1.0.3.16
CPE Version	1.0.4.100
System Uptime	3 hours 17 minutes
Firmware Status	<div style="background-color: #95a5a6; padding: 5px; font-size: 0.8em;">Press check button and reload the page to check firmware availability</div> <div style="text-align: center; margin-top: 5px;">Check</div>

System Temperature	38°C (100.4°F)
Tamper Sensor	Triggered
Door Control	Untriggered
Digit Output	Untriggered
Digit Input 1	Untriggered
Digit Input 2	Untriggered

Product Model	Displays the Product Model.
Hardware Version	Displays the Hardware Version.
Part Number	Displays the Part Number.
Boot Version	Displays the Boot Version.
Core Version	Displays the Core Version.
Base Version	Displays the Base Version.
Prog Version	Displays the Prog Version.
CPE Version	Displays the CPE version.
System UpTime	Displays the time since the first boot of the GDS3705.
Firmware Status	Click the Check button to check whether the firmware in the firmware server has an updated version, if so, update immediately.
System Temperature	Shows the current system temperature (in °C and °F)
Tamper Sensor	Shows if the Tamper Sensor is triggered or not.
Door Control	Shows if the door control is triggered or not (in case door is opened for example it will show triggered)
Door 1 Ctrl	Shows if Door 2 is opened.
Door 2 Ctrl	Shows if Door 2 is opened.
Input Digit 1	Shows if Alarm-IN 1 is triggered.

Input Digit 2	Shows if Alarm-IN 2 is triggered.
Digit Output	Shows if digital output is triggered.

System Info

Network Info

This page displays the network system information of GDS370x.

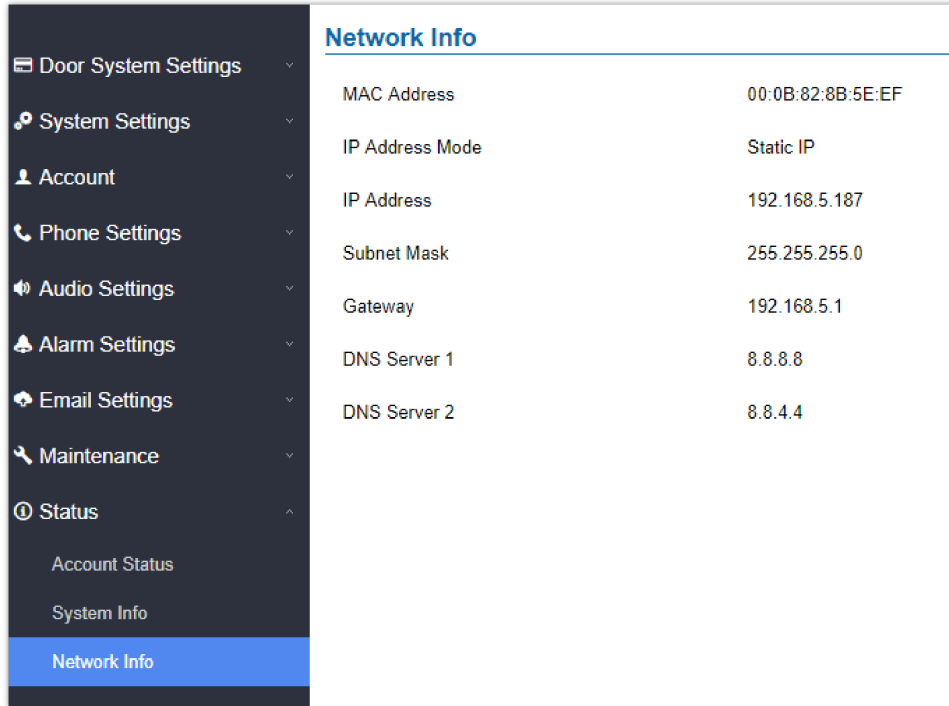

Network Info Page

MAC Address	Displays the GDS370x MAC Address.
IP Address Mode	Displays the IP address mode used.
IP Address	Displays the IP address of the GDS370x.
Subnet Mask	Displays the Subnet Mask used.
Gateway	Displays the GDS370x Gateway.
DNS Server 1	Displays the Preferred DNS Server.
DNS Server 2	Displays the secondary DNS Server.

Network Info

FACTORY RESET

Restore to Factory Default Via Web GUI

To perform factory reset to the GDS370x via the Web GUI, please refer to following steps:

1. Access to GDS370x Web GUI using the using the shipped default password.

2. Navigate to **Maintenance → Reboot & Reset**.

3. Select the reset type from Rest drop down menu and press reset button as displayed on the following screenshot.

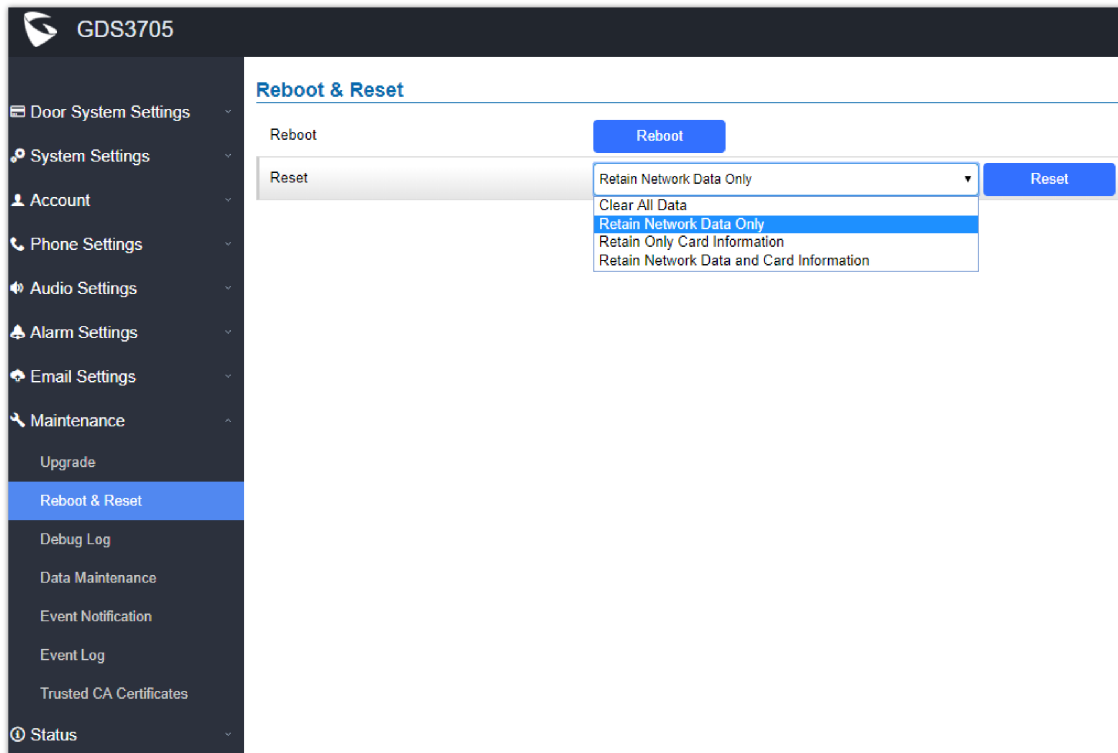

Note

When Resetting the device, "Retain Only Crad Information", and "Retain Network Data and Card Information" Options are available only on the GDS3705 Model.

Hard Factory Reset

Note

Resetting the device on the Wiegand interface cable is supported only on the GDS3705 Model.

Some users did not keep the revised password safely and forgot the changed password. Due to GDS370x did NOT have built-in reset button (Grandstream purposely designed this way to enhance security), this will make the GDS370x inaccessible even for the true owner who lost the changed password.

Below is a photo of the normal connection of the provided Wiegand cable.

Important Note

Power must NOT be lost while performing hard factory reset.



To perform a hard factory reset to the GDS3705, please refer to the following steps:

1. Power OFF the GDS3705.
2. Take the provided Wiegand cable, and connect (or shorting) the related color wires as illustrated on the following picture. Please make sure the connection is correct and solid:
 - Connect **WHITE** and **BROWN** cable together.
 - Connect **GREEN** and **ORANGE** cable together.

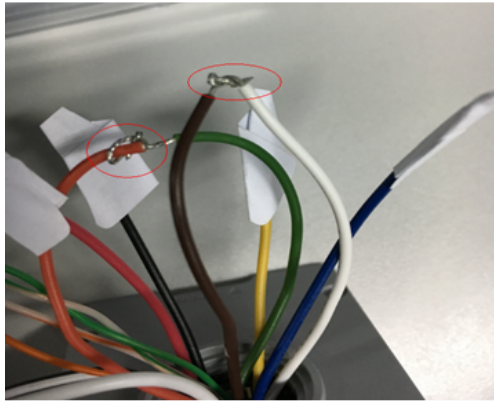

Wiegand Cable Connection

3. Power ON the GDS3705. In about 10 seconds, the keypad LED lighting will change from solid lighting to blinking, the blinking time window is about 30 seconds. The user needs to enter the following key combination ***0#** while the LED is blinking.

Notes:

- If the correct key combination is inputted, the last key input will play with a long tone, illustrating the correct key combination entered, then the GDS3705 will get into factory reset mode.
- During the blinking time window, if the user does not finish the key combination operation, or pressed the wrong key combination, the GDS3705 will play short beep quickly three times illustrating error. Nothing will happen and the GDS3705 will get into normal booting process. User who wants to do hard factory reset has to perform the operation from the beginning again.

4. After 3 ~ 5 minutes the GDS3705 will finish performing the reset process, then the user can log into the GDS3705 web GUI using the shipped default password.

5. User must power OFF the GDS3705, unplug the Wiegand cable, power ON the GDS3705 again and make sure the GDS3705 is running correctly.

Hard Factory Reset Using GS Search

Note

GDS3705 does not support gs_search recovery function, only GDS3702 supports it.

The GDS3702 can be reset using the GS Search tool by following these steps :

1. Open the GS Search tool that can be downloaded from the [Grandstream tools page](#).

2. Select the device in question, in our example it is the GDS3702, and then select Facility Device Password Recovery.

3. Perform the reset of the device by clicking the Reset button option, after providing the initial default password, found on a sticker on the unit.

Restore to Factory Default Via SIP NOTIFY

1. Access your GDS370x UI by entering its IP address in your favorite browser.
2. Go to the Phone Settings # page.
3. Enable "Allow Reset Via SIP NOTIFY" by checking this option. (Default is disabled)
4. Once a **SIP NOTIFY** with "**event: reset**" is received, the GDS370x will perform factory reset after authentication phase.

Note

Received SIP NOTIFY will be first challenged for authentication purpose before taking factory reset action.

The authentication can be done either using an admin password (if no SIP account is configured) or via SIP account credentials (SIP User ID and Password).

Reset Factory Password Via Special Key Combination Operation

Note

This configuration is exclusive to the GDS3705 Model.

This feature allows customers to reset the device administrator password to factory default via keypad operation through some special key combination. When performing this operation, ONLY the password will be reset back to factory default. All other settings or parameters will NOT be changed and will remain the same. This feature is specially designed for field engineers or technicians when dispatched in the field but for some reason, the administrator password is not available therefore not able to access the GDS37xx device to do the related maintenance.

Here are the steps to do such a password reset operation via keypad:

Encoding Rules:

Alphabet A – Z mapping to digit 1 – 26 respectively, no difference in lower or up case.

A	B	C	D	E	F	J	H	I	G	K	L	M	N	O	P	Q	R	S	T	U	V	W	X	Y	Z
1	2	3	4	5	6	7	8	9	10	11	12	13	14	15	16	17	18	19	20	21	22	23	24	25	26

Notes

1. MAC address of the GDS370x (check the sticker at back of the device)
2. Default password of the GDS370x (check the sticker at the back of the device)
3. Correct decoding the last 6 MAC address into digits (refer to encoding rule)
4. Correct decoding the default password into digits (refer to encoding rule)
5. Finish keypad input within 1 minute

Operation Steps:

1. When device is idle, input the special keypad combination with format: *****last_6_MAC**#**
2. Device will reach restore mode after correct digits in Step 1) entered. The backlight of keypad will flash quickly to tell operator the device is now in password reset/restore mode.
3. Operator will enter the correct decoded default password ending with # with format: **default_password_code#** via the keypad within 60 seconds.
4. If wrong code combination entered, the GDS3705 will beep with error sound (three short beeps) then exit the password reset mode, and the backlight will stop flashing.
5. If the correct default password decoded entered within 60 seconds, GDS3705 will play a long beep sound (advising correct operation), the device will reboot itself automatically.
6. If keypad entry time out (not finish the input within 60 seconds), the device will exit this password reset mode automatically and stop the backlight flashing.
7. After successful password reset, operator will then be able to log into the GDS3705 webUI with default password, all the configuration inside the device will be the same and will NOT be changed.

For example:

Decoding the string into digits and write to paper before doing the operation:

Device with last 6 MAC address: **33DDDD**

Decoding the last 6 MAC to digits would be: **334444**

Default password is: **xwpxz6AA**

Decoding the default password to digits would be: **2423162426611**

1. Enter *****334444**#** via keypad, get into the password reset mode, the keypad backlight will flash quickly.
2. Within 60 seconds, enter **2423162426611#**, the device will play one long beep then reboot itself.
3. Wait the device finishing boot up, log in the web UI using the default password, **xwpxz6AA**

CHANGE LOG

This section documents significant changes from previous versions of the user manual for GDS370x. Only major new features or major document updates are listed here. Minor updates for corrections or editing are not documented here.

Firmware Version 1.0.3.16

- Added configurable "Onhook Timer after Remote Open Door". [[Onhook Timer after Remote Open Door](#)]
- Revised "Zero Config" option wording to "3CX Auto Provision". [[3CX Auto Provision](#)]
- Added ability to manually turn off the alarm output after the call ends or DTMF matches. [[Turn Off Alarm Output After Hang up Alarm Call](#)]
- Improved Alarm Email Subject and Text. [[Email Subject](#)] [[Email Content](#)]
- Integrated new DigiCert certificates. [[DigiCert](#)]
- Added ability to define the TLS protocol level. [[Minimum TLS Version](#)] [[Maximum TLS Version](#)]
- Added the audit of admin logging information to the Event Logs. [[Event Log](#)]
- Added support of HTTP API request when web access set to HTTPS. [[HTTP API Open Door Compatibility Mode](#)]
- Added support for 802.1X. [[802.1X Mode](#)]
- Added support for DHCP Option 2. [[Allow DHCP Option 2 to Override Time Zone Setting](#)]
- Added feature to "Enable SIP Calling Trigger Alarm Output" in "Alarm Events Config". [[Enable SIP Calling Trigger Alarm Output](#)]
- Added support for Emergency PIN to Re-enable Keep Door Open. [[Emergency PIN to Re-enable Keep Door Open](#)]
- Added sending "event type", "username" and "card ID" in the email event for open door. [[Email Content](#)]
- Added configure the "Alarm Output Duration" to last longer or unlimited. [[Alarm Output Duration](#)]
- Added support for SNI extension on TLS. [[Server Name Indication](#)]
- Updated the CPE to version 1.0.4.100 [[CPE Version](#)]
- Added sending PIN Code via Wiegand when HTTP API open door executed. [[Enable HTTP API Remote Open Door](#)]
- Added "Keep Door Open" to support multiple schedules to be selected and used. [[Schedule Keep Door Open](#)]
- Added initiating a normal call as alarm output. [[Audio Alarm to SIP Phone](#)]
- Added ability to on hook after API command to open door. [[Enable HTTP API Remote Open Door](#)]
- Added granular Digital Output time duration. [[Alarm Output Duration](#)]
- Added Basic Authentication to open door via HTTP API. [[Enable HTTP API Remote Open Door](#)]
- Enhanced security by including "X-Content-Type-Options" header in HTTP response. [[Enable HTTP API Remote Open Door](#)]
- Enhanced security by including HSTS(Strict-Transport-Security) header in HTTP response. [[Enable HTTP API Remote Open Door](#)]

- Enhanced security by including "X-XSS-Protection" header in HTTP response. [[Enable HTTP API Remote Open Door](#)]
- Added option of not using "#" after PIN input so the device behaves like traditional access controller when "Disable Keypad SIP Number Dialing" enabled. [[Disable Keypad SIP Number Dialing](#)]

Firmware Version 1.0.3.11

- Added ability to disable CFG download with password (ITSP/Telefonica). [[CFG Download](#)]
- Added support for configuring different "Number Called When Door Bell Pressed" entries depending on the time frame or schedule. [[Number Called When Door Bell Pressed](#)]

Firmware Version 1.0.3.10

- Added TR069/GDMS support. [[TR-069](#)]

Firmware Version 1.0.1.21

- Cisco WebEx IOT: Added Web UI Option "SIP URI Scheme When Using TLS" and "Support SIP Instance ID" [[Table 15: SIP Account Basic & Advanced Settings](#)]
- Added support for configurable keypad blue light On/Off. [[Table 5: Door System Settings](#)]
- Added unauthorized card swiped on wired external 3rd party Wiegand reader will also have alert message in event Log [[Event Log](#)]
- Increased Whitelist Number to maximum 200 in each Account [[Table 17: White List](#)]
- Added prompt "Alarm Schedule Name" and "Alarm Action Profile Name" cannot be blank. [[Alarm Config](#)]
- 3CX IOT: Support "Add MAC in User-Agent" and Added "Codec Negotiation Priority" configuration [[Table 15: SIP Account Basic & Advanced Settings](#)]
- Added error prompt if illegal port value is set to web access [[Table 12: Access Settings](#)]

Firmware Version 1.0.1.16

- Added open door without SIP call when paired with GSC3570. [[Door opening without SIP Call](#)]
- Added scheduled Auto Reboot. [[Auto Reboot](#)]
- Enhanced open door via 3rd party Webrelay ON/OFF URL. [[Table 5: Door System Settings](#)]
- Added Alarm Action triggering when illegal card swiped. [[Alarm Action When Illegal Card Swiped](#)]
- Added enable/disable password display on Web UI when using HTTPs. [[Table 12: Access Settings](#)]
- Added secure open door with GDS3705/GSC3570 setup. [[Secure Open Door via GDS3705/GSC3570 Peering](#)]
- Added the time zone GMT-03:30 for Newfoundland. [[Time Zone](#)]

Firmware Version 1.0.1.11

- Added OpenVPN® support. [[OpenVPN® Settings](#)]
- Added WebRelay Open Door Feature. [[Door System Settings](#)]
- Increased Unlock Holding Time to 30 minutes. [[Table 5: Door System Settings](#)]
- Changed SIP Account Name to Display Name. [[Table 15: SIP Account Basic & Advanced Settings](#)]
- Added reboot/resync via SIP Notify. [[Disable SIP NOTIFY Authentication](#)]

Firmware Version 1.0.1.6

- Added support for failover mechanism based on DNS SRV. [[Table 15: SIP Account Basic & Advanced Settings](#)]
- Added siren alarming function when door opened abnormally (special wiring required). [[Siren alarming when door opened abnormally](#)]
- Added including Holidays at Keep Door Open schedule. [[Holiday Mode](#)]
- Added reset/restore factory default password via special keypad combination operations. [[Reset Factory Password](#)]

Firmware Version 1.0.1.3

- Added support for re-registration before expiration. [Table 15: SIP Account Basic & Advanced Settings]
- Enhanced security and prevent ghost calls. [Table 15: SIP Account Basic & Advanced Settings]
- Added support for DHCP Option 42. [Allow DHCP Option 42 to override NTP server]
- Added support for Voice Frame Per TX at audio settings. [Table 15: SIP Account Basic & Advanced Settings]
- Added support of separated webUI credentials for GDSManager. [GDSManager Configuration Password]
- Added support for G.729 audio codec. [Table 15: SIP Account Basic & Advanced Settings]
- Added ability to enable multiple audio codecs simultaneously and specify priority of codecs. [Table 15: SIP Account Basic & Advanced Settings]
- Added support for randomize firmware upgrade and provisioning. [Upgrade]

Firmware Version 1.0.0.41

- Added support for second door control via Alarm Output 1. [Using Alarm Out (COM 1) to Control a Second Door]
- Added support for "Normal Open" or "Normal Close" setting when Alarm Out1 is set to Open Door. [ALMOUT1 Status]
- Added option to specify digital input to be normal Open or normal Close. [Digit Input 1 Status]
- Added support for using Digit Only as Private PIN. [Local PIN Type]
- Added support for System Health Alerts via Email. [System Health Alert]
- Added option to upload custom doorbell ringtone. [Enable Custom Doorbell Ringtone]
- Added option to disable WEB/SSH access. [Access Settings]
- Added option for calling out automatically without pressing #. [No Key Input Timeout(s)]
- Added option to disable SIP dialing from GDS keypad. [Disable Keypad SIP Number Dialing]
- Added option to set Schedule for "Local PIN to Open Door". [Local PIN to Open Door Schedule]
- Added option to customize DTMF Payload. [DTMF Payload Type]
- Added RTCP/RTCP-XR for SIP Call. [Technical Specifications] [Enable RTCP]
- Added Boot version information into System status. [System Info]
- Enhanced security by only allowing numbers existing under "White List" to open the door remotely when call is initiated from GDS3705. [Remote PIN to Open the Door]
- Added option to synchronize Keep Door Open from GDSManager version 1.0.1.1 or later. [Central Mode]

Firmware Version 1.0.0.37

- Added event log showing the users (Username) opening door via private PIN [Event Log]
- Added SIP NOTIFY to factory reset [Allow Reset Via SIP NOTIFY] [Restore to Factory Default Via SIP NOTIFY]
- Added option to disable outbound proxy route header [Outbound Proxy Mode]
- Added option to verify received SIP Message [Validate Incoming Messages]

Firmware Version 1.0.0.36

- Added support for special character "@" in the SIP User ID. [SIP User ID]
- Added SIP password hided and not visible in the Web UI. [Password]
- Extended VLAN range from 0-4094. [Layer 2 QoS 802.1Q/VLAN Tag]
- Added ability to configure device with custom certificate signed by custom CA certificate [Certificates]
- Added option to display device temperature in Fahrenheit. [System Temperature]

Firmware Version 1.0.0.35

- Added option to assign a schedule to the doorbell. [Press Doorbell Schedule]
- Added option to set the maximum number of digits dialed. [Maximum Number of Dialed Digits]
- Added support for Parallel Hunting when doorbell pressed. [Door Bell Call Mode]
- Added firmware check status button. [Firmware Status]

- Added Account section. [Account]
- Enhanced Event Notification Template Variables. [Event Notification]
- Added Random Port option. [Use Random Port]
- Added NAT Traversal option. [NAT Traversal]
- Added Doorbell Call Out Account. [Doorbell Call Out Account]
- Add ability to set schedule for Alarm IN door opening. [Input Digit]
- Added Account Status section. [Account Status]

Firmware Version 1.0.0.31

- Added "Enabled but Not Forced; Enabled and Forced" under SRTP Configuration. [Enable SRTP]

Firmware Version 1.0.0.28

- Added alarm notification of non-scheduled access users. [Non-Scheduled Access Alarm]
- Added support for HTTP command to Open Door [Enable HTTP API Remote Open Door]
- Added Keep Door Open section. [Keep Door Open]
- Added "Test" Button for Alarm Action. [Alarm Config]

Firmware Version 1.0.0.26

- Added displaying logs at device Web UI. [Event Log]
- Added ability to upload Trusted CA certificate files. [Trusted CA certificate]
- Added option to enable/disable certificate validation. [Validate Server Certificate]
- Added Ability to configure Start/End Valid date for users. [Card Management]
- Changed password recovery email option to user settings page. [User Management]
- Added UI showing Temperature/TamperSensor/DoorControl/DI/DO in the System Info Page [System Info]
- Added Support for system events notification via HTTP. [Event Notification]
- Added Factory Functions for Audio Loopback and Certificate Verification. [Factory Functions]

Firmware Version 1.0.0.20

- This is the initial version for GDS3705.